

# Modesty

International Germany



**Catalogue 2011/12**

### Some useful hints

how to prepare Surgical Instruments for sterilization:

1. **Before** sterilization, the instruments must be cleaned and disinfected by means of appropriate detergents. Resistently sticking deposits are carefully removed by means of a soft brush in order to prevent corrosion and/or other injuries being caused to the instruments. Under no circumstances a metal wire brush should be used.
2. On account of the fact that the residues of cleaning agents are acting upon metal and may cause corrosion, detergent treated instruments, after having been chemically cleaned, must be thoroughly rinsed in clear water. Preferably, the last rinsing should be done in distilled or demineralized water to prevent the formation of rust.
3. The operating instructions of the manufacturers of sterilizers, ultrasonic and disinfecting equipment must be carefully read and followed before setting agoing such installations. Above all this warning applies to cases where such equipment is used for the first time.
4. Articulated instruments should be cleaned and sterilized in open position only.
5. Before sterilization, the instruments must be dried up carefully and, subsequently, be immersed into the liquid concentrate (instrument caring milk) which has been specially developed for this purpose or be drizzled with oil spray for instruments.
6. Special care must be taken that **dry instruments only** are placed into the sterilizer, as, otherwise, stains or water spots may develop on the surfaces of the instruments.

In case there remain questions to be answered, please, do not hesitate to ask us.

### Quelques indications utiles

à observer lors de la préparation d'instruments chirurgicaux à la stérilisation.

1. **Avant** la stérilisation, les instruments doivent être nettoyés et désinfectés au moyen de détersifs appropriés. Eloigner des sédiments adhérents au moyen d'une brosse souple pour éviter la corrosion ou l'endommagement des instruments. Eviter à tout prix de se servir d'une brosse métallique.
2. En considération du fait que les résidus de produits chimiques à nettoyer sont susceptibles d'attaquer le métal et de provoquer la corrosion, il est indispensable qu'après leur nettoyage les instruments soient soigneusement rincés dans de l'eau limpide. Pour le dernier rinçage, recommandation est faite de se servir d'eau distillée ou d'eau déminéralisée pour parer à la rouille.
3. Les modes d'emploi des fabricants d'appareils de stérilisation, d'ultrasons et de désinfection doivent être soigneusement lus et exactement suivis. Cette recommandation vaut surtout pour la première mise en marche d'appareils des types indiqués.
4. Des instruments articulés doivent être toujours nettoyés et stérilisés en position ouverte.
5. Avant leur stérilisation, les instruments doivent être soigneusement séchés et ensuite être plongés dans le concentré aqueux (lait garde-instruments) spécialement développé à ce propos. Un autre moyen consiste dans l'arrosage par spray huileux pour instruments.
6. Attention doit être faite à ce que seulement des **instruments bien secs** soient placés dans le stérilisateur, autrement il serait à craindre qu'ils se produisent des taches d'eau sur les surfaces des instruments .

Dans le cas où vous auriez besoin de renseignements supplémentaires, veuillez ne pas hésiter à nous les demander.

### **Qualche raccomandazione utile per la sterilizzazione degli strumenti chirurgici.**

1. **Prima** della sterilizzazione, gli strumenti debbono essere lavati e disinfettati per mezzo di detersivi appropriati. Rimuovere residui pertinaci con l'aiuta d'una spazzola molla onde evitare corrosione e danneggiamento degli strumenti. In nessun caso servirsi d' una spazzola metallica.
2. Giacche gli agenti di disinfezione e di pulitura hanno influenza molto aggressiva e possono causare corrosione, è indispensabile che, dopo il lavaggio e la disinfezione, gli strumenti siano risciacquati accuratamente in acqua pura. Di preferenza usare acqua distillata per l'ultimo lavaggio onde prevenire la formazione di ruggini.
3. Le istruzioni per l'uso edite dai fabbricanti degli sterilizzatori e degli apparecchi ultrasonici per la lavatura e la disinfezione debbono essere studiate prima della loro messa in opera e accuratamente seguite durante il processo. Vale questo soprattutto per la sterilizzazione della prima volta.
4. Strumenti articolati (p.e. pinze e forbici) debbono essere puliti e sterilizzati solamente in posizione aperta.
5. Prima della sterilizzazione, si raccomanda di immergere gli strumenti nella soluzione acquosa sviluppata specialmente per la cura degli strumenti chirurgici e dentali (latte per strumenti) o di annaffiarli mediante il spray oleoso speciale creato a questo proposito.
6. E molto importante che soltanto strumenti **assolutamente secchi** si mettano nello sterilizzatore giacche, in caso contrario, le facce degli strumenti sarebbero coperte di chiazze d'acqua.

Restiamo alla Vostra disposizione per il caso di bisognarVi informazioni ulteriori rispetto a ciò.

## **NÜTZLICHE TIPS ZUR INSTRUMENTENAUFBEREITUNG**

- 1) Instrumente sind vor der Sterilisation mit geeigneten Spezialmitteln zu desinfizieren und zu reinigen. Hartnäckige Ablagerungen mit weicher Bürste entfernen, um Korrosionen und Beschädigungen an den Instrumenten zu vermeiden. Keinesfalls Metallbürste verwenden.
- 2) Da Desinfektions- und Reinigungsmittelrückstände Metall angreifen und Korrosionen hervorrufen können, ist es notwendig, die Instrumente nach dem Desinfizieren und Reinigen gründlich mit klarem Wasser abzuspülen. Vorzugsweise sollte man für die letzte Spülung destilliertes Wasser verwenden, um so der Rostanfälligkeit vorzubeugen.
- 3) Die Bedienungsanleitungen der Hersteller von Sterilisatoren, Ultraschall-Reinigungs- und Desinfektionsgeräten sind vor Inbetriebnahme derselben unbedingt durchzulesen und genauestens zu befolgen. Dies gilt besonders vor der Erststerilisation.
- 4) Instrumente mit Gelenken sollten nur in geöffneter Stellung gereinigt und sterilisiert werden.
- 5) Vor der Sterilisation sollten die Instrumente am besten in speziell zur Pflege von Chirurgie- und Dentalinstrumenten entwickelte Instrumentenpflegemilch eingetaucht oder mit Instrumenten-Öl-Spray eingesprüht werden.
- 6) Es ist unbedingt darauf zu achten, daß nur trockene Instrumente sterilisiert werden, da sich sonst Flecken auf den Instrumentenoberflächen bilden.

Bei weiteren Fragen stehen wir Ihnen gern zur Verfügung.

### **Algunas indicaciones útiles**

que se recomienda observar al preparar instrumentos quirúrgicos para la esterilización.

1. **Antes** de esterilizarlos, es necesario limpiar y desinfectarlos usando detergentes apropiados. Quitar incrustaciones muy adherentes mediante un cepillo blando para prevenir corrosión y otros deterioros de los instrumentos. De ningún modo servirse de cepillos metálicos.
2. Dado que residuos eventuales de detergentes tenderían a atacar la superficie metálica y a provocar su corrosión, es indispensable, después de la limpieza, fregarlos cuidadosamente en agua pura. Para el último enjuague, recomendamos el uso de agua destilada o desmineralizada para prevenir así toda posibilidad de oxidación.
3. Se impone el estudio exacto y la observancia estricta de las instrucciones de manejo redactadas por los fabricantes de esterilizadores, de aparatos de limpieza por ultrasonido y de equipos de desinfección. Esto vale sobre todo para la primera puesta en marcha de dichos aparatos.
4. Para instrumentos articulados sirve como norma que deben ser limpiados y esterilizados siempre en posición abierta.
5. Antes de su esterilización, los instrumentos deben ser secados cuidadosamente. El próximo paso consiste en sumergirlos en el concentrato líquido especialmente desarrollado para cuidar instrumentos quirúrgicos (leche guardainstrumentos) o en rociarlos con el rocío oleoso especial para instrumentos de cirugía.
6. Particular atención debe pagarse a lo que todos los instrumentos sean **absolutamente secos** antes de meterlos en el esterilizador. En el caso contrario se corre el riesgo de que se formen manchas de agua sobre las superficies de los instrumentos.

Caso de necesitarse informaciones adicionales, rogamos a Vds. pedírselas.

## Table of Contents / Table des matières

Group / Groupe		Page/Page
02	Diagnostics / <i>Diagnostic</i>	1 - 7
04	Anesthesia / <i>Anesthésie</i>	8 - 9
06	Scalpels, Knives / <i>Bistouris, Couteaux</i>	10 - 16
08, 09	Scissors / <i>Ciseaux</i>	18 - 33
10, 11	Thumb and Tissue Forceps / <i>Pinces à dissection</i>	34 - 40
12	Hemostatic Forceps / <i>Pinces hémostatiques</i>	42 - 57
12	Tubing Clamps / <i>Pinces serre-tube</i>	58
14	Towel Clamps / <i>Pinces à champs</i>	59
16	Polypus and Dressing Forceps / <i>Pinces à pansements et à polypes</i>	60 - 63
18	Retractors / <i>Ecarteurs</i>	64 - 87
20	Probes, Cotton Applicators / <i>Stylets, Sondes, Porte-coton</i>	88 - 89
22	Trocars, Puncture Needles / <i>Trocarts, Aiguilles à ponction</i>	90 - 91
24, 26	Suture / <i>Suture</i>	92 - 104
28	Sterilizing Aids / <i>Instruments pour stérilisation</i>	105
30	Plaster-of-Paris / <i>Bandages plâtrés</i>	106 - 108
32-36	Bone Surgery, Osteosynthesis / <i>Chirurgie osseuse, Ostéosynthèse</i>	109 - 166
40	Neurosurgery, Laminectomy / <i>Neurochirurgie, Laminectomie</i>	167 - 177
42	Ophthalmology / <i>Ophtalmologie</i>	178 - 197
44	Otology / <i>Otologie</i>	198 - 211
46	Rhinology / <i>Rhinologie</i>	212 - 229
48	Mouth and Tongue / <i>Bouche et langue</i>	230 - 234
50	Tonsils / <i>Amygdales</i>	235 - 238
52	Larynx / <i>Larynx</i>	239 - 241
53	Flexible Forceps, Endoscopic / <i>Pinces flexibles endoscopiques</i>	242 - 244
54	Tracheostomy / <i>Trachéotomie</i>	245 - 246
54	Goitre / <i>Goitre</i>	247
56	Thorax / <i>Thorax</i>	248 - 255
62	Gall Bladder / <i>Vesicule biliaire</i>	256 - 257
64	Kidney / <i>Rein</i>	258
64	Intestines, Stomach / <i>Intestin, Estomac</i>	259 - 266
66	Urology / <i>Urologie</i>	267 - 271
68	Rectum / <i>Rectum</i>	272 - 275
70	Gynecology / <i>Gynécologie</i>	276 - 299
72	Obstetrics / <i>Obstétrique</i>	300 - 305
74	Dermatology, Hygiene / <i>Dermatologie, Hygiène</i>	306 - 307
88	Instrument Boxes and Trays / <i>Boîtes et plateaux à instruments</i>	308 - 312
90	HF Surgery (Diathermy) / <i>Chirurgie à haute fréquence</i>	314 - 319

## Tabla del contenido / *Indice delle sezioni*

Grupo / Gruppo		Página/Pagina
02	Diagnóstico / <i>Diagnostica</i>	1 - 7
04	Anestesia / <i>Anestesia</i>	8 - 9
06	Bisturíes, Cuchillos / <i>Bisturi, Coltelli</i>	10 - 16
08, 09	Tijeras / <i>Forbici</i>	18 - 33
10, 11	Pinzas de disección / <i>Pinze per dissezione</i>	34 - 40
12	Pinzas hemostáticas / <i>Pinze emostatiche</i>	42 - 57
12	Pinzas para tubos / <i>Pinze serratubi</i>	58
14	Pinzas para campos / <i>Pinze fissateli</i>	59
16	Pinzas para pólipos y esponjas / <i>Pinze per polipi e per tamponi</i>	60 - 63
18	Separadores / <i>Divaricatori</i>	64 - 87
20	Estiletes, Sondas, Porta-algodón / <i>Specilli, Sonde, Portacotone</i>	88 - 89
22	Trócares, Agujas para punción / <i>Trequarti, Aghi da punzione</i>	90 - 91
24, 26	Sutura / <i>Sutura</i>	92 - 104
28	Auxilios para la esterilización / <i>Utensili per la sterilizzazione</i>	105
30	Vendajes enyesados / <i>Bendaggi gessati</i>	106 - 108
32-36	Cirugía ósea, osteosíntesis / <i>Chirurgia ossea, osteosintesi</i>	109 - 166
40	Neurocirugía, Laminectomía / <i>Neurochirurgia, Laminectomia</i>	167 - 177
42	Oftalmología / <i>Oftalmologia</i>	178 - 197
44	Otología / <i>Otologia</i>	198 - 211
46	Rinología / <i>Rinologia</i>	212 - 229
48	Boca y lengua / <i>Bocca e lingua</i>	230 - 234
50	Amígdalas / <i>Tonsille</i>	235 - 238
52	Laringe / <i>Laringe</i>	239 - 241
53	Pinzas flexibles endoscópicas / <i>Pinze flessibili endoscopiche</i>	242 - 244
54	Traquetomía / <i>Tracheotomia</i>	245 - 246
54	Bocio / <i>Gozzo</i>	247
56	Tórax / <i>Torace</i>	248 - 255
62	Vesícula biliar / <i>Vescicola biliare</i>	256 - 257
64	Riñón / <i>Rene</i>	258
64	Intestines, Estómago / <i>Intestini, Stomaco</i>	259 - 266
66	Urología / <i>Urologia</i>	267 - 271
68	Recto / <i>Retto</i>	272 - 275
70	Ginecología / <i>Ginecologia</i>	276 - 299
72	Obstetricia / <i>Ostetricia</i>	300 - 305
74	Dermatología, Higiene / <i>Dermatologia, Igiene</i>	306 - 307
88	Contenedores y bandejas / <i>Contenitori, vassoi e bacinelle</i>	308 - 312
90	Cirugía de alta frecuencia / <i>Chirurgia ad alta frequenza</i>	314 - 319



# Inhaltsübersicht

Gruppe		Seite
02	Diagnostik	1 – 7
04	Anaesthesie	8 – 9
06	Skalpelle, Messer	10 – 16
08, 09	Scheren	18 – 33
10, 11	Pinzetten	34 – 40
12	Arterienklemmen	42 – 57
12	Schlauchklemmen	58
14	Tuchklemmen	59
16	Tupferzangen, Kornzangen	60 – 63
18	Wundhaken, Wundsperrer	64 – 87
20	Sonden, Watteträger	88 – 89
22	Trokare, Punktionsnadeln	90 – 91
24, 26	Naht	92 – 104
28	Sterilisier-Hilfen	105
30	Gipsverband	106 – 108
32-36	Orthopädie, Osteosynthese	109 – 166
40	Neurochirurgie, Laminektomie	167 – 177
42	Ophthalmologie	178 – 197
44	Otologie	198 – 211
46	Rhinologie	212 – 229
48	Mund und Zunge	230 – 234
50	Tonsillen	235 – 238
52	Larynx	239 – 241
53	Flexible Endoskopie-Zangen	242 – 244
54	Tracheotomie	245 – 246
54	Kropf	247
56	Thorax	248 – 255
62	Galle	256 – 257
64	Niere	258
64	Darm, Magen	259 – 266
66	Urologie	267 – 271
68	Mastdarm	272 – 275
70	Gynäkologie	276 – 299
72	Geburtshilfe	300 – 305
74	Dermatologie, Hygiene	306 – 307
88	Behälter, Siebschalen	308 – 312
90	Hochfrequenz-Chirurgie	314 – 319

Blutdruckmessapparate  
Blood Pressure Apparatus  
Tensiomètres  
Esfigmomanómetros  
Sfigmomanometri



M2.110.00  
compl



Econom  
M2.110.00  
M2.112.00



M2.122.00  
compl



M2.132.00  
compl.

Diagnostik  
Diagnostics  
Diagnostic  
Diagnóstico  
Diagnostica



COLLIN  
M2.140.01 Erwachsene . Adult  
M2.140.02 Kinder . Child . Enfant  
ninos . Bambini



FRANKE  
M2.145.00



M2.147.00



VARIFOCAL  
M2.160.00

MAY  
M2.162.00

Diagnostik-Bestecke  
Diagnostic Sets  
Trousses à diagnostic  
Juegos para diagnóstico  
Astucci per diagnostica



M2.170.00  
Combination



M2.172.00  
Universal

M2.173.00  
Exonom universal



M2.174.00  
Otoskop . Otoscope . Otoscopio

Stirnspiegel, -lampen  
Head Mirrors, Head Lights  
Miroirs, lampes frontales  
Espejos, lámparas frontales  
Riflettori, lampade frontali

Stirnlampen  
Head lights  
Lampes frontales  
Lamparas frontales  
Lampade frontali



M2.180.91



ZIEGLER  
M2.180.90  
compl.

M2.180.92



CLAR  
M2.190.00  
comp.  
6V.



M2.190.01



M02.195.00  
compl.  
6V.



M2.295.01



6 Volt  
M2.199.06

Stethoskope  
Stethoscopes  
Stéthoscopes  
Estetoscopios  
Stetoscopi



**BOWLES**  
MY02.240.00



**FORD**  
MY02.242.00



**DUPLEX**  
MY02.246.00



**FORD-BOWLES**  
MY02.244.00



**PINARD**  
MY02.260.15  
15 cm



**PINARD**  
MY02.262.18  
18 cm

Perkussionshämmer  
Percussion Hammers  
Marteaux-percuteurs  
Martillos de percusión  
Martelli percussori



TAYLOR  
M2.288.17 - 17 cm  
M2.288.20 - 20 cm



TRAUBE  
M2.290.16



BABINSKY  
M2.292.22  
22 cm



TROEMER  
M2.294.24  
24 cm



DEJERINE  
M2.302.20



DEJERINE  
M2.304.20



BERLINER  
M2.304.20



BUCK  
M2.308.18

Diagnostik  
Diagnostics  
Diagnostic  
Diagnóstico  
Diagnostica

Schädel-messzirkel  
Cephalometer  
Cephalometre  
Cefalometro  
Cefalometro



BERTILLON  
M2.310.01

Winkelmesser  
Goniometer  
Goniometre  
Goniometro  
Goniometro



MOELTEGEN  
M2.312.01

Naderad . Pinwheel.  
Aesthesiometre . Sensimetro



WARTENBERG  
M2.320.19  
19 cm

Metall -Meßstäbe  
Rulers, metal  
Regles en metal  
Reglas de metal  
Regoli in acciaio



Cm	inch.	
10	4	M2.340.10
20	8	M2.340.20
30	12	M2.340.30
50	20	M2.340.50



M2.344.15  
15 cm

Maßband, Stahl  
Tape measure, steel  
Ruban metrique en acier  
cinta metrica de acero  
nastrometrico di acciaio



M2.350.15  
1,5 m



Aspiration, Anaesthesie  
 Aspiration, Anesthesia  
 Aspiration, Anesthésie  
 Aspiración, Anestesia  
 Aspirazione, Anestesia



POOLE  
 M4.130.10  
 10 mm

POOLE  
 M4.140.08  
 8 mm

YANKAUER  
 M4.150.27  
 27 cm

M4.190.25  
 1/4  
 M4.190.20  
 1/4  
 M4.190.17  
 1/4

cm MAGILL  
 17 M4.190.17  
 20 M4.190.20  
 25 M4.190.25



McINTOSH Fig.  
 Set/3 M4.203.00 2-4  
 Set/4 M4.204.00 1-4

McINTOSH  
 Cold Light Fig.  
 M4.203.01 2-4  
 M4.204.01 1-4



FOREGGER Fig.  
 M4.223.00 2-4  
 M4.224.00 1-4

Laryngoskope  
Laryngoscopes  
Laryngoscopes  
Laringoscopios  
Laringoscopi



Fig. 0



Fig. 1



Fig. 2



Fig. 3



Fig. 4



Fig. 1



Fig. 2



Fig. 3



Fig. 4

Cm	fig.	Normal McINTOSH	Cold Light
5,5	0	M4.210.00	M4.211.00
7,5	1	M4.210.01	M4.211.01
9,0	2	M4.210.02	M4.211.02
11,0	3	M4.210.03	M4.211.03
13,5	4	M4.210.04	M4.211.04

Cm	Fig	FOREGGER
7,0	1	M4.220.01
9,0	2	M4.220.02
11,0	3	M4.220.03



M4.239.01  
f./p. Fig. 1



M4.239.02  
f./p. Fig. 2-4



Cold Light  
f.Zp. Fig. 2-4



M4.240.00

Ø mm	
28	M4.234.28
37	M4.234.37

Skalpelli  
Scalpel Handles  
Manches de bistouris  
Mangos de bisturios  
Manici per bisturi



M6.103.00  
fig. 3



M6.103.01  
Fig. 3 Grad.



M6.103.02  
Fig. 3 L



M6.104.00  
Fig. 4



M6.104.02  
Fig. 4 L



M06.107.00  
Fig. 7



M6.107.01  
Fig. 7 K



M6.108.00  
Fig. 8

In Packungen a 100  
in Packages of 100 ea  
en boites de 100 c/u  
in scatole di 100 pezzi

Skalpellinge, steril  
Scalpel Blades, Sterile  
Lames de bistouris, stériles  
Hojas de bisturíes estériles  
Lame da bisturi, sterili

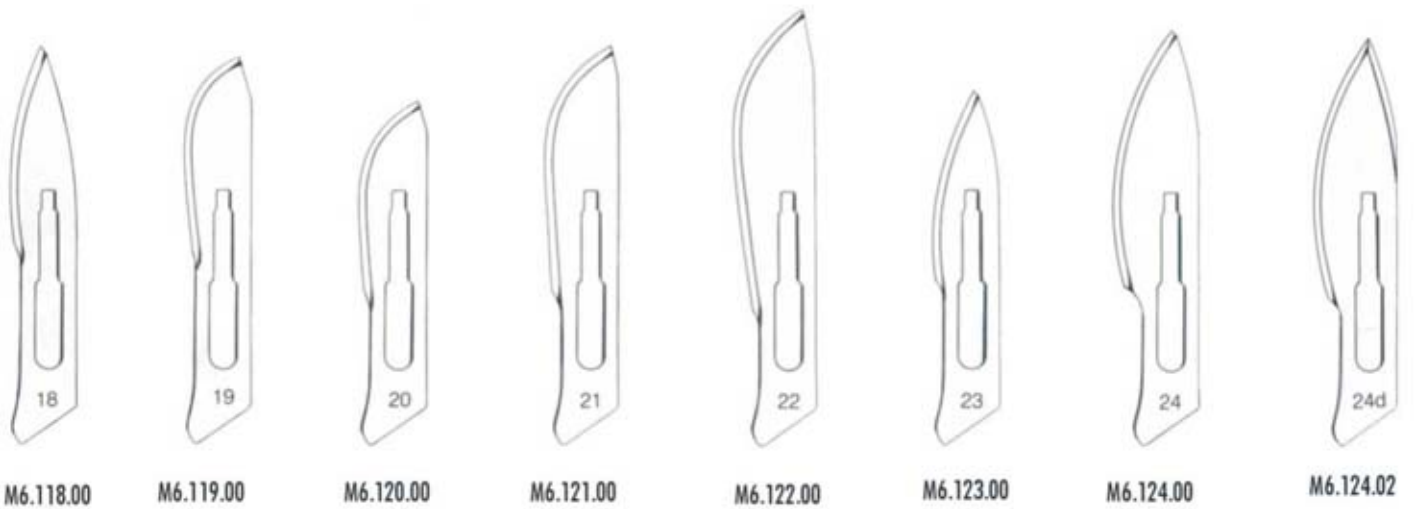

Einmalskalpelle, steril  
 Disposable Scalpels, Sterile  
 Bistouris usage unique, stériles  
 Bisturías uso único, estériles  
 Bisturi monouso, sterili



M6.210.00  
 Fig. 10



M6.211.00  
 Fig. 11



M06.211.00  
 Fig. 12



M6.212.02  
 Fig. 12d



M6.213.00  
 Fig. 13



M6.215.00  
 Fig. 15



M6.215.01  
 Fig. 15c



M6.218.00  
 Fig. 18



M6.219.00  
 Fig. 19



M6.220.00  
 Fig. 20



M6.221.00  
 Fig. 21



M6.222.00  
 Fig. 22



M6.223.00  
 Fig. 22



M6.224.00  
 Fig. 24



M6.225.00  
 Fig. 5

Klingenbrecher, Rasierklingen  
Blade Breakers, Razor Blades  
Casse-lames, rasoirs  
Rompe-hojas, hojas de afeitar  
Pinze rompe-lamette, lamette



TROUTMAN-CHRIS  
M6.290.09  
9 cm



M6.291.11  
11 cm



CASTROVIEJO  
M6.294.13  
13 cm



M6.296.00  
Packung = 10  
Package = 10  
Boite = 10  
Cajita = 10 c/u  
Scattola = 10

Skalpelle mit Metallheft  
Scalpels with Metal Handle  
Bistouris, manche métal  
Bisturías, mango metálico  
Bisturi, manico di metallo



M6.402.01-M6.402.10



M6.402.01  
Fig. 1



M6.402.02  
Fig. 2



M6.402.03.03  
Fig. 3



M6.402.04  
Fig. 4



M6.402.05  
Fig. 5



M6.402.06  
Fig. 6



M6.402.07  
Fig. 7



M6.402.08  
Fig. 8



M6.402.09  
Fig. 9



M6.402.10  
fig. 10



PACKER  
M6.408  
Fig. 10



PACKER  
M6.4.8.02  
Fig. 2

Allgemeine Chirurgie  
General Surgery  
Chirurgie générale  
Cirugía general  
Chirurgia generale

Amputationsmesser  
amputating knives  
couteaux a amputatio  
cuchillos para amputacion  
Coltelli per amputazione

Dermatom  
Dermatome  
Dermatome  
Dermatomo  
Dermatomo

Resektionsmesser  
Resection knives  
Couteaux a resection  
Cuchillos p. Reseccion  
Coltelli per resezione



LANGENBECK  
M6.410.05  
L = 55 cm



LANGENBECK  
M6.412.05  
L = 5,5 cm



L = cm  
13 M.420.13  
16 M6.420.16  
19 M6.420.19  
22 M6.420.19  
28 M6.420.28



L = cm LISTON  
17 M6.430.17  
20 M6.430.20



SCHINK  
M6.430.17  
30 cm compl.



06.490.01

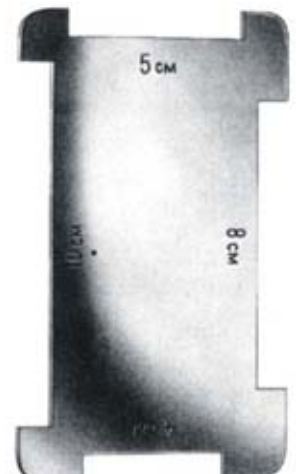

M6.490.02

L = Klingenlänge/length  
of blade/longueur tranchant/  
lango de cortelunghessa di taglio



Allgemeine Chirurgie  
General Surgery  
Chirurgie générale  
Cirugia general  
Chirurgia generale



M6.496.00

Rasiermesser  
Razor  
Rasoir  
Navaja  
Rasoio

Abziehstein  
Oil stone  
Pierre a repasser  
Piedra afiladora  
Pietraper affilare



Arkansas  
M6..499.00



VIRCHOW  
M6.960.25



Knorpel-, Hirnmesser  
Carilage, brain knife  
Couteaux a cartilage, a cerveau  
Cuchillo para cartilgos y p. Cerbro  
Coltelli per cartilagini e per il cervello

L = cm

16 M6.980.16  
20 M6.980.20  
24 M6.980.24

Chirurgische Scheren  
 Operating Scissors  
 Ciseaux à chirurgie  
 Tijeras para cirugía  
 Forbici per chirurgia

TC Schneiden  
 TC Cutting Edges  
 Tranchant TC  
 Dilos de corte TC  
 Taglio TC



Cm	Standard	TC
10,5	M8.102.10	
11,5	M8.102.11	
13,0	M8.102.13	
14,5	M8.102.14	M8.140.14
15,5	M8.102.15	
16,5	M8.102.16	M8.104.16
18,5	M8.102.18	
20,0	M8.102.20	



Cm	Standard	TC
10,5	M8.110.10	
11,5	M8.110.11	
13,0	M8.110.13	
14,5	M8.110.14	M8.114.14
15,5	M8.110.15	
16,5	M8.110.16	M8.114.16
18,5	M8.110.18	
20,0	M8.110.20	



Standard	TC
M8.120.10	
M8.120.11	
M8.120.13	
M8.120.14	M8.124.14
M8.120.15	
M8.120.16	M8.124.16



Cm	Standard	TC
10,5	M8.103.10	
11,5	M8.103.11	
13,0	M8.103.13	
14,5	M8.103.14	M8.105.14
15,5	M8.103.15	
16,5	M8.103.16	M8.105.16
18,5	M8.103.18	
20,0	M8.103.20	



Cm	Standard	TC
10,5	M8.111.10	
11,5	M8.111.11	
13,0	M8.111.13	
14,5	M8.111.14	M8.115.14
15,5	M8.111.15	
16,5	M8.111.16	M8.115.16
18,5	M8.111.18	
20,0	M8.111.20	



Cm	Standard	TC
10,5	M8.121.10	
11,5	M8.121.11	
13,0	M8.121.13	
14,5	M8.121.14	M8.125.14
15,5	M8.121.15	
16,5	M8.121.16	M8.125.16
18,5	M8.121.18	
20,0	M8.121.20	

Chirurgische Scheren  
Operating Scissors  
Ciseaux à chirurgie  
Tijeras para cirugía  
Forbici per chirurgia



14 cm M8.128.14



DAYVER

M8.130.14 M8.131.14  
M8.134.14 M8.135.14



DAYVER

M8.140.14 M8.141.14  
M8.144.14 M8.145.14



DAYVER

M8.150.14 M8.151.14



Cm MAYO  
14,5 M8.160.14 M8.170.14  
M8.164.14 M8.165.14  
17,0 M8.160.17 M9.161.17  
M8.164.17 M8.165.17  
M8.160.23 M8.161.23  
M8.164.23 M8.165.23

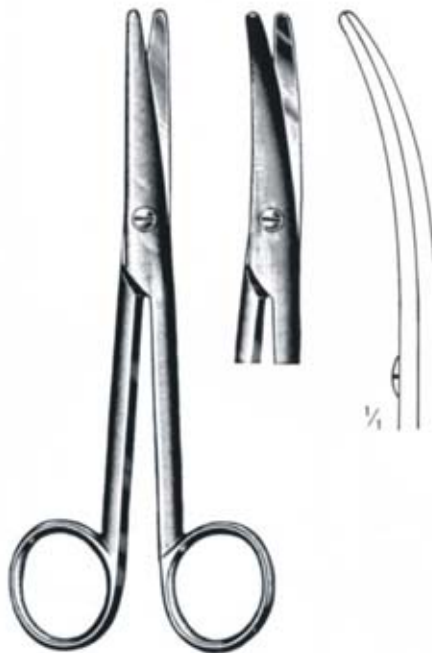

Cm MAYO-STYLLE  
15,0 M8.170.15 M8.170.15  
M8.174.15 M8.175.15  
17,0 M8.170.17 M8.171.17  
M8.174.17 M8.175.17

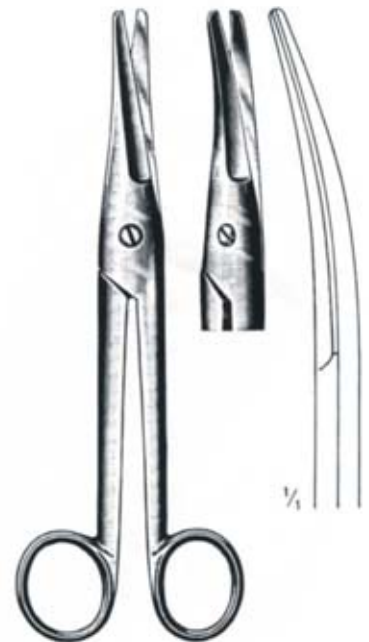

MAYO-NOBLE  
M8.180.7 M8.181.17

Präparierscheren  
Dissecting Scissors  
Ciseaux à dissection  
Tijeras de disección  
Forbici per dissezione



Cm LEXER

16	M8.190.16	M8.194.16
21	M8.190.21	M8.194.21

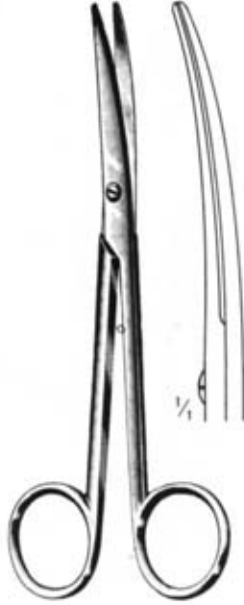

LEXER

M8.191.6	M8.195.16
M8.191.21	M8.195.21

TC Schneiden  
TC Cutting Edges  
Transchant TC  
Filos de corte TC  
Taglio TC

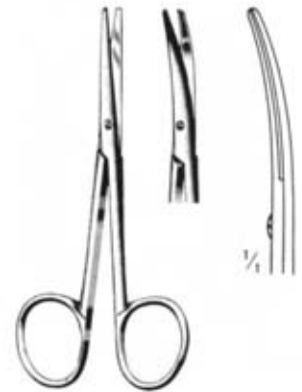

Cm 10

LEXER	BABY
M8.202.10	M8.203.10
M8-286-18	M8.207.10



cm METZENBAUM

15	M8.280.15	M8.284.15
18	M8.280.18	M8.284.18
20	M8.280.20	M8.284.20
23	M8.280.23	M8.284.23
25	M8.280.25	M8.284.25
28	M8.280.28	M8.284.28
30	M8.280.30	M8.284.30



METZENBAUM

M8.281.15	M8.285.15
M8.281.18	M8.285.18
M8.281.20	M8.285.20
M8.281.23	M8.285.23
M8.281.25	M8.285.25
M8.281.28	M8.285.28
M8.281.30	M8.285.30

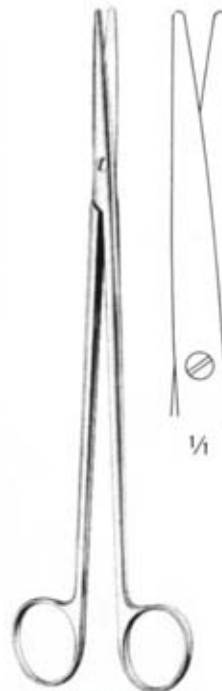

METZENBAUM FINO

M8.282.15	M8.286.15
M8.282.18	M8.286.18
M8.282.20	M8.286.20
M8.282.23	M8.286.15
	M8.286.18
	M8.286.15

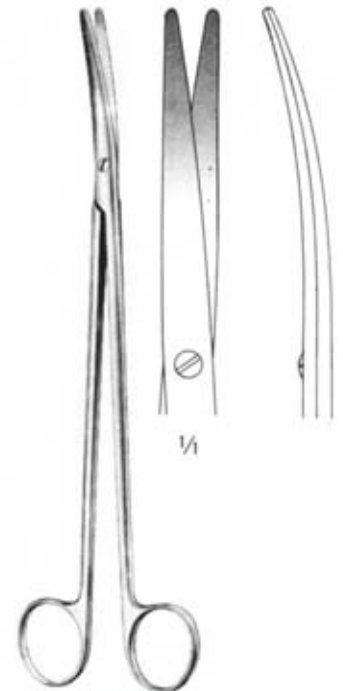

METZENBAUM FINO

M8.283.15	M8.287.15
M8.283.18	M8.287.18
M8.283.20	M8.287.20
M8.283.15	M8.287.23
	M8.287.25
	M8.287.30

Chirurgische Scheren  
Operating Scissors  
Ciseaux à chirurgie  
Tijeras para cirugía  
Forbici per chirurgia

Plastik . Plastic . Plastique . Plastica . Plastica



**METZENBAUM "S"**  
18 cm M08.291.28  
M08.295.18



**SANVENERO**  
M08.302.14 14 cm M08.303.14



**JOSEPH**  
M08.304.14 14 cm M08.305.14

Iris - Standard



**KILNER**  
cm 12 M08.310.12 M08.314.12  
15 M08.310.15 M08.314.15



**REYNOLDS**  
M08.314.12 15 cm M08.321.15  
M08.314.15 M08.325.15



M08.340.09 9 cm M08.341.09  
M08.340.11 11 cm M08.341.11  
M08.344.11 M08.345.11

Tonsillen-, Gefäß-Scheren  
Tonsil, Vascular Scissors  
Ciseaux amygdal., vasculaires  
Tijeras, amígdal., vasculares  
Forbici, tonsill., vascolari

Nase . Nase . Nasale

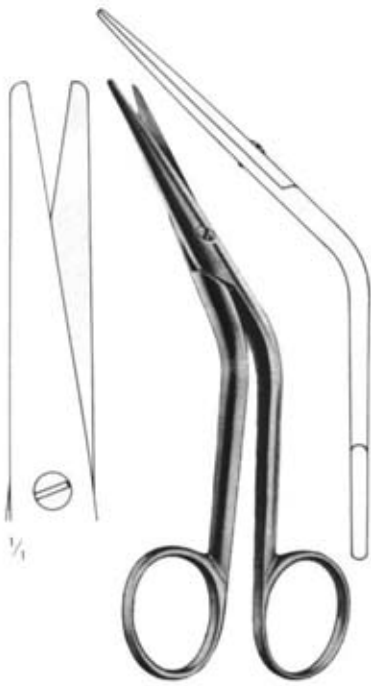

**COTTLE**  
M8.405.16  
16 cm

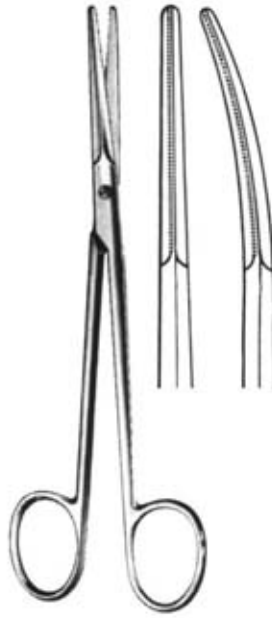

**BEUSE**  
M8.430.14 14 cm M8.421.14  
M8.430.18 18 cm M8.421.18



**DEAN**  
M8.435.17 17 cm M8.437.17

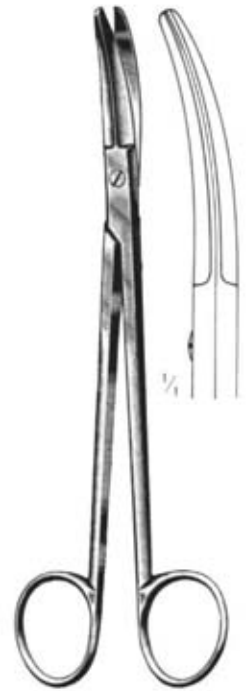

**BOETTCHER**  
M8.435.18  
18 cm

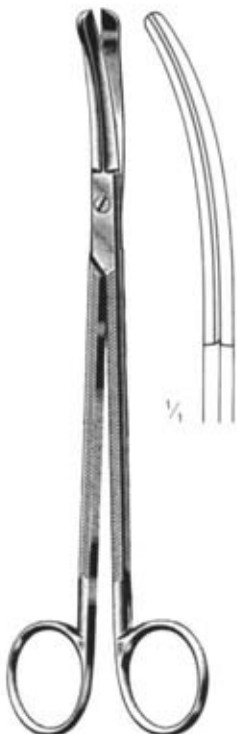

**GOOD**  
M8.437.19  
19 cm

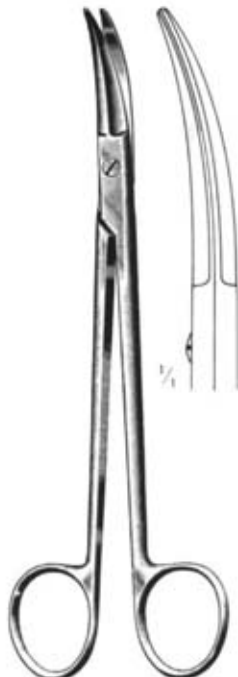

**PRINCE**  
M8.439.17  
17 cm



M8.46.8.15  
15 cm



M8.470.11  
11 cm

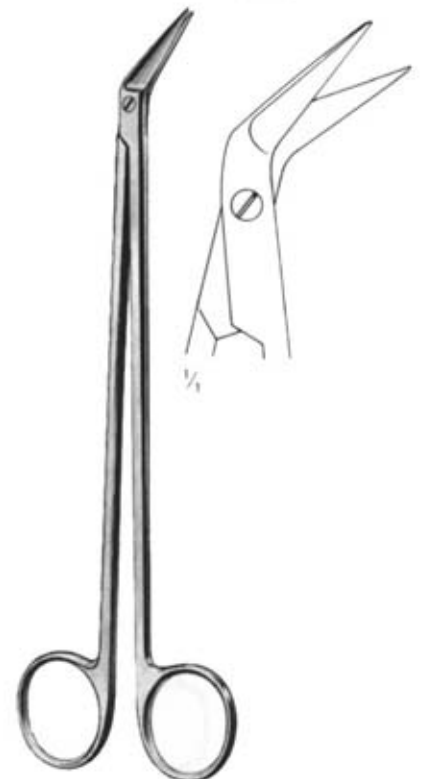

**POTTS - DE MARTEL**  
cm 21 M8.473.21  
24 M8.473.24

Gefäß-Scheren  
 Vascular Scissors  
 Ciseaux vasculaires  
 Tijeras vasculares  
 Forbici vascolari

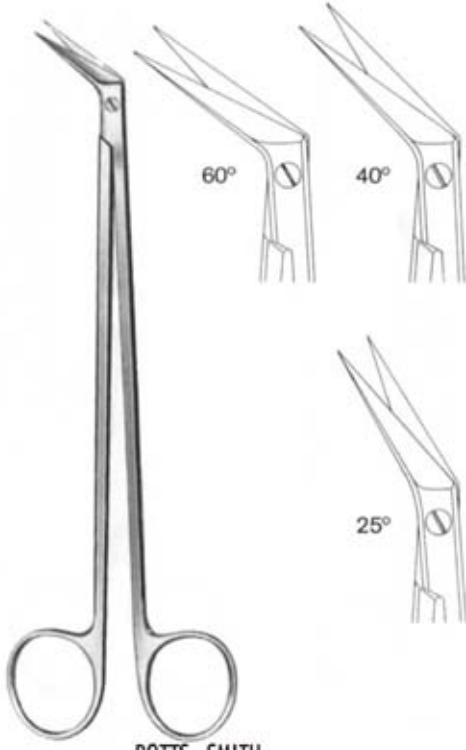

POTTS - SMITH  
 19 cm

25°	M8.480.25	M8.484.25
40°	M8.480.40	M8.484.25
60°	M8.480.60	M8.484.25

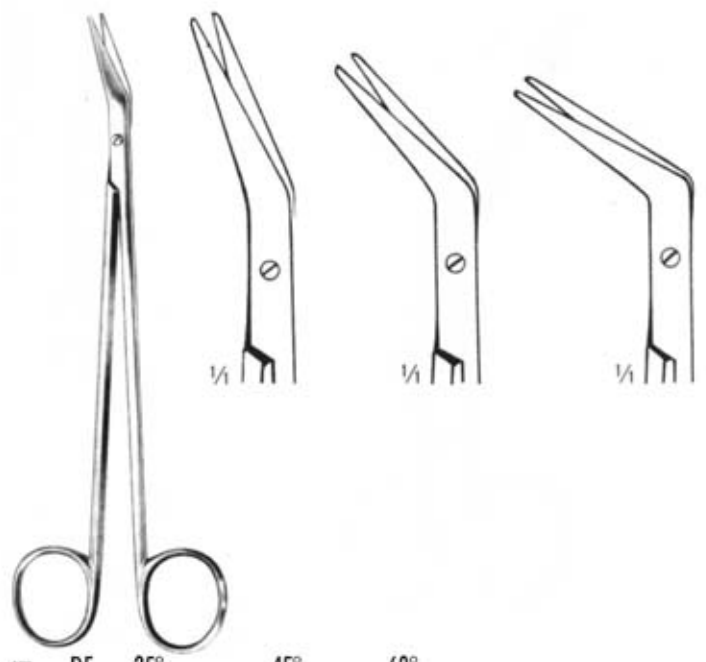

cm DE 25° 45° 60°

16	M8.490.16	M8.491.16	M8.492.16
23	M8.490.23	M8.491.23	M8.492.23
28	M8.490.28	M8.491.28	M8.492.28

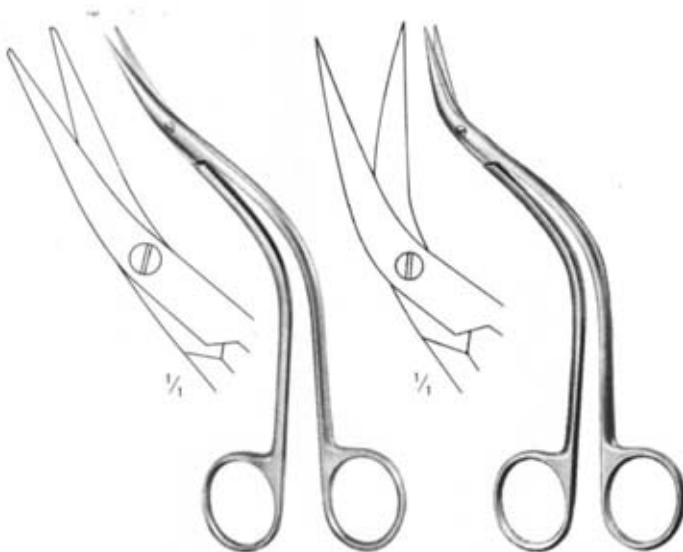

DE BAKEY  
 M8.495.15  
 15,5 cm

DE BAKEY  
 M8.497.15  
 15,5 cm



Paramentrium . Parametrio

M8.501.15 - M8.505.23

M8.501.22	M8.501.23
M8.505.22	M8.505.23
22,5 cm	23 cm

Gynäkologische Scheren  
Gynaecological Scissors  
Ciseaux gynécologiques  
Tijeras ginecológicas  
Forbici ginecologiche

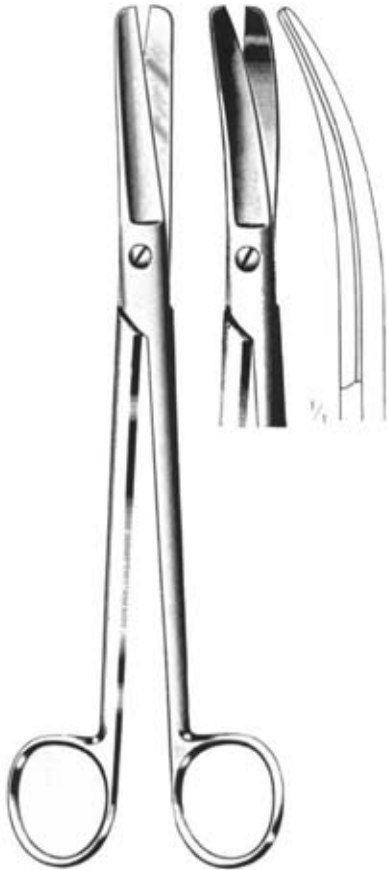

**SIMS**  
Cm 20 M8.510.20 M8.511.20  
23 M8.510.23 M8.511.23  
M8.514.23 M8.515.23

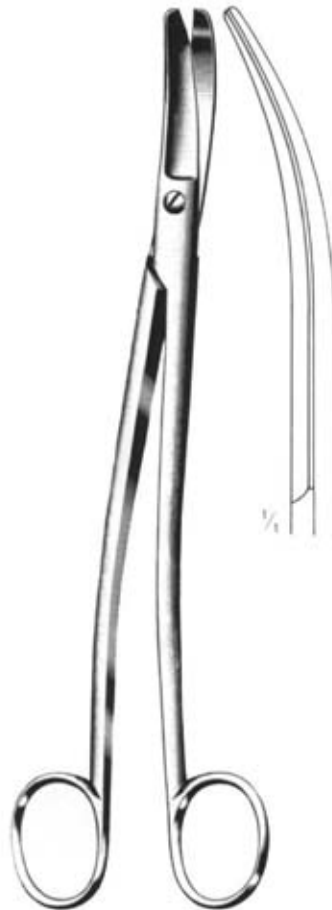

**SIEBOLD**  
M8.523.24  
24 cm

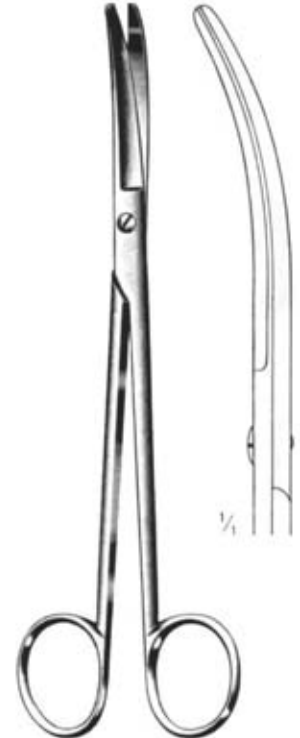

**WERTHEIM**  
M8.525.22  
22,5 cm

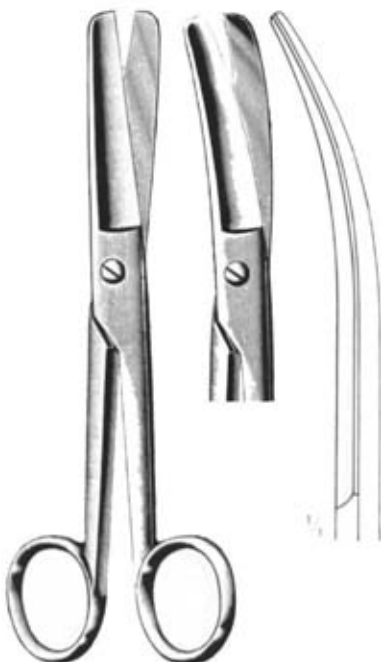

**DOYEN**  
Cm 17,5 M8.530.17 M8.531.17



**DUBOIS**  
cm 27 M8.536.27 M8.537.27

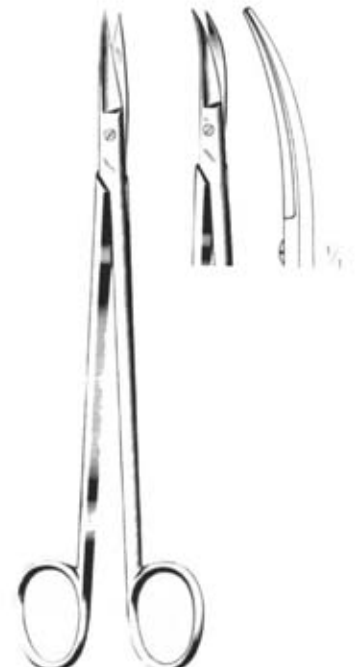

**KELLY**  
cm 16 M8.540.16 M8.541.16  
18 M8.540.18 M8.541.18



Chirurgische Scheren  
 Operating Scissors  
 Ciseaux à chirurgie  
 Tijeras para cirugía  
 Forbici per chirurgia

Nabelschur-Scheren  
 Umbilical Scissors  
 Ciseaux ombilicaux  
 Tijeras umbilicales  
 Forbici ombelicali



U.S.A. Mod.  
 M8.550.10  
 10,5 cm



BUSCH  
 M8.551.16  
 16 cm



SCHUMACHER  
 M8.553.16  
 14 cm

Episiotomie . Episiotomy .  
 Episiotomia



cm BRAUN-STADLER  
 14,5 M8.560.14  
 22,0 M8.560.22

Neurochirurgie . Neurosurgery.  
 Neurocirurgia . Neurochirurgia



cm  
 M8.580.11 11 M8.681.11



cm  
 M8.582.15 11 M8.583.15



STRULLY  
 M8.601.22  
 22 cm



TOENNIS-ADSON  
 M8.610.18  
 18 cm

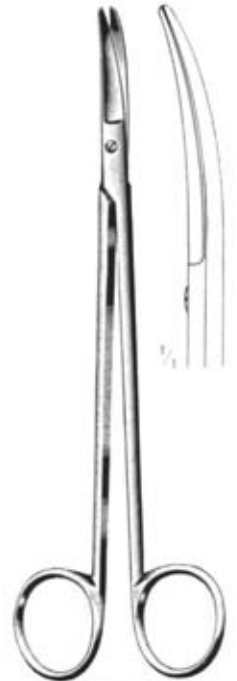

TOENNIS-ADON  
 M8.611.18  
 18 cm

Chirurgische Scheren  
Operating Scissors  
Ciseaux à chirurgie  
Tijeras para cirugía  
Forbici per chirurgia

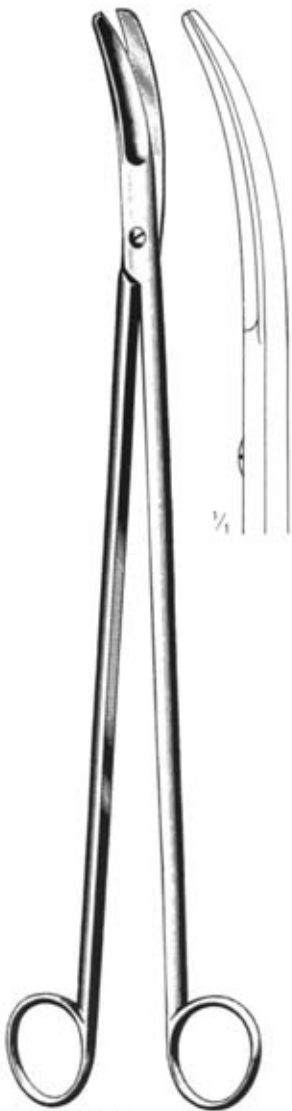

**CRAFOORD**  
M8.641.30  
30 cm



**McINDOE**  
M8.614.19  
19 cm



**DANY**  
M8.617.17  
17 cm



**SCHMIEDEN-TAYLOR**  
M8.619.17  
17 cm

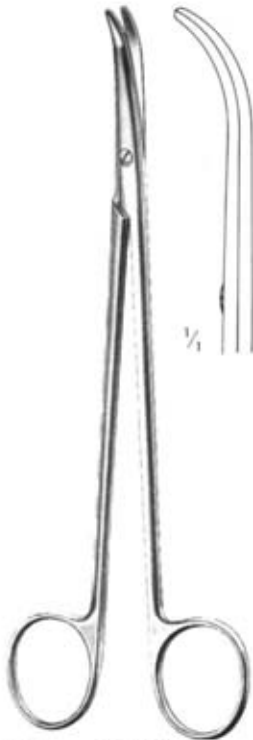

cm  
**THOREK**  
19 M8.643.18  
25 M8.643.25

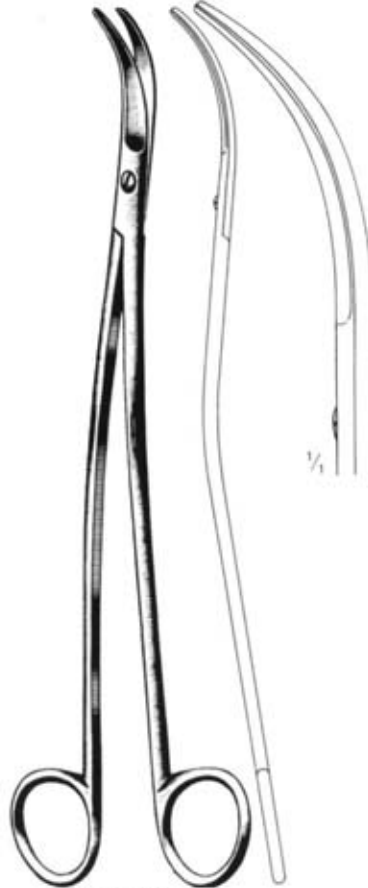

**SATINSKY**  
M8.651.24  
24,5 cm

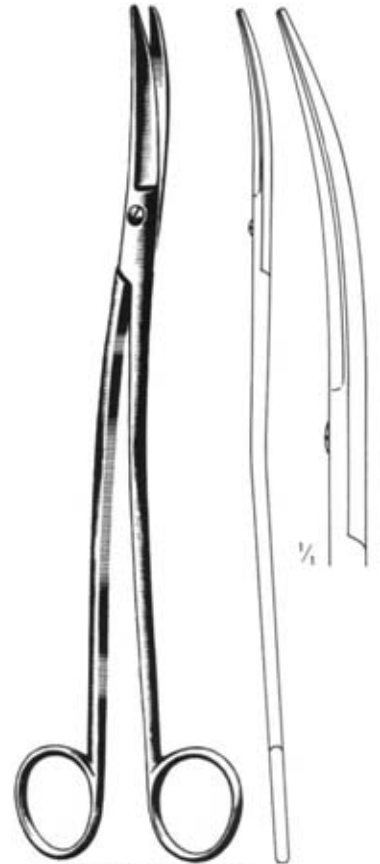

**KLINKENBERGH-LOTH**  
M8.661.23  
23

Chirurgische Scheren  
Operating Scissors  
Ciseaux à chirurgie  
Tijeras para cirugía  
Forbici per chirurgia



M8.770.21  
21 cm



M8.772.21  
21 cm



M8.774.21  
21 cm

Darmscheren  
Enterotomy Scissors  
Ciseaux à enterotomie  
Enterrotomos  
Forbici per enterotomia

Ligarurscheren  
Ligature Scissors  
Ciseaux à ligatures  
Tijeras para puntas  
Forbici per legature



SPENCER  
M8.802.09  
9 cm



SPENCER  
M8.802.11  
11 cm



NORTHBENT  
M8.803.13  
13 cm



LITTAUER  
M8.804.14  
14 cm



HEATH  
M8.809.15  
15 cm

Chirurgische Scheren  
Operating Scissors  
Ciseaux à chirurgie  
Tijeras para cirugía  
Forbici per chirurgia

Zahnfleischscheren  
Gum Scissors  
Tijeras para encías  
Forbici gengivali



M8.820.13

13 cm

M8.821.13

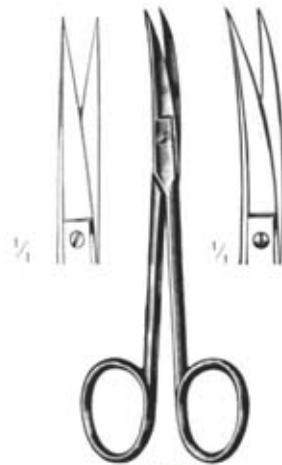

M8.824.12

WAGNER

12 cm

M8.825.12



QUINBY

M8.827.12

Draht-, Blechscheren  
Wire and plate shears  
Ciseaux a fils et plaques metalliques  
Tijeras para alambre y chapas  
Forbici per filo di metallo e lamiera



UNIVERSAL

M8.835.12

**M8.835.12**

12 cm



BEEBEE

M8.850.10

10 cm

M8.851.10

Gaza  
Gauze  
Gaze  
Gaza  
Garza



SMITH US ARMY

M8.898.20

20 cm

Verband-Scheren  
 Bandage Scissors  
 Ciseaux à bandages  
 Tijeras para vendajes  
 Forbici per bendaggi



cm LISTER  
 11 M8.901.11  
 14 M8.901.14  
 18 M8.901.18  
 M8.905.18  
 20 M8.901.20



BERGMANN  
 M8.911.23  
 23 cm



cm ESMARCH  
 20 M8.913.20  
 22 M8.913.22



cm Excenter  
 16 M8.921.16  
 19 M8.921.19



KNOWLES  
 M8.930.14  
 14 cm



LORENZ  
 M8.933.23  
 23 cm



BRUNS  
 M8.935.23  
 M8.937.23  
 M8.939.23  
 23 cm



M8.941.20  
 20 cm



cm UNIVERSAL  
 15 M8.950.15  
 18 M8.950.18

Augen-Scheren  
Ophthalmic Scissors  
Ciseaux oculaires  
Tijeras oculares  
Forbici oculistiche

Sehnen-, Iris-Scheren  
Tendon, Iris Scissors  
Ciseaux a iris et tendons  
Tijeras iris y para tendones  
Forbici per iride e tendini



WESTCOTT  
M9.102.11  
11 cm



WESTCOTT  
M9.104.11  
11 cm



NOYES  
M9.110.12  
12 cm



WECKER  
M9.113.11-M9.117.11  
11 cm



M9.113.11



M9.115.11



M9.117.11

Hornhautschere  
Corneal scissors  
Ciseaux corneens  
Tijeras corneales  
Forbici corneali



McGUIRE  
M9.121.10  
10 cm

Iridektomie . Iridectomy  
Iridectomia



CASTROVIEJO  
M9.133.10  
10 cm



CASTROVIEJO  
M9.135.10  
10 cm



MARRAQUER  
M9.119.10  
(Colibri) 5,5 cm, 10 mm

Augen-, Mikro-Scheren  
Ophthalmic, Micro Scissors  
Ciseaux oculaires, micro-ciseaux  
Tijeras oculares, microquirúrgicas  
Forbici oculistiche, micro-chirurg.

Iridektomie, Hornhaut  
Iridectomy, corneal  
Iridectomie, cornéens  
Iridectomia, corneal  
Iridectomia, corneale



VANNAS  
M9.140.08



VANNAS  
M9.141.08  
8 cm



M9.202.18-M9.205.18  
8 mm



CASTROVIEJO  
M9.151.11  
11 cm



CASTROVIEJO  
M9.153.11  
11 cm



CASTROVIEJO  
M9.155.11  
11 cm

Mikrochirurgie  
Micro Surgery  
Microchirurgie  
Microcirurgia  
Microchirurgia



M9.202.18 18 cm



M9.203.18



M9.204.14 18 cm  
(GYN)

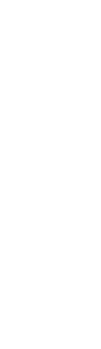

M8.205.18





Pinzetten  
Thumb and Tissue Forceps  
Pincès à dissection  
Pinzas de disección  
Pinze per dissezione

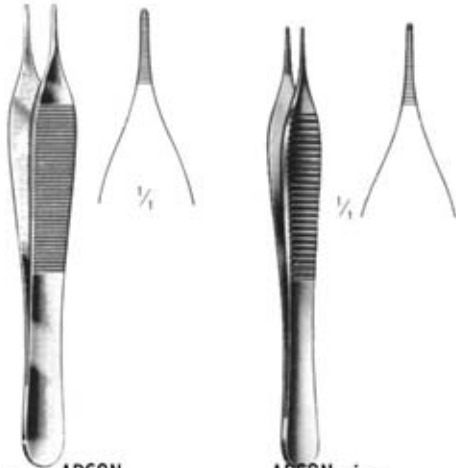

cm	ADSON	ADSON micro
12,0	M10.170.12	M10.176.12
12,0	M10.174.12	
15,0	M10.170.15	
15,0	M10.174.15	



CUSHING  
M10.220.17  
M10.224.17  
17 cm

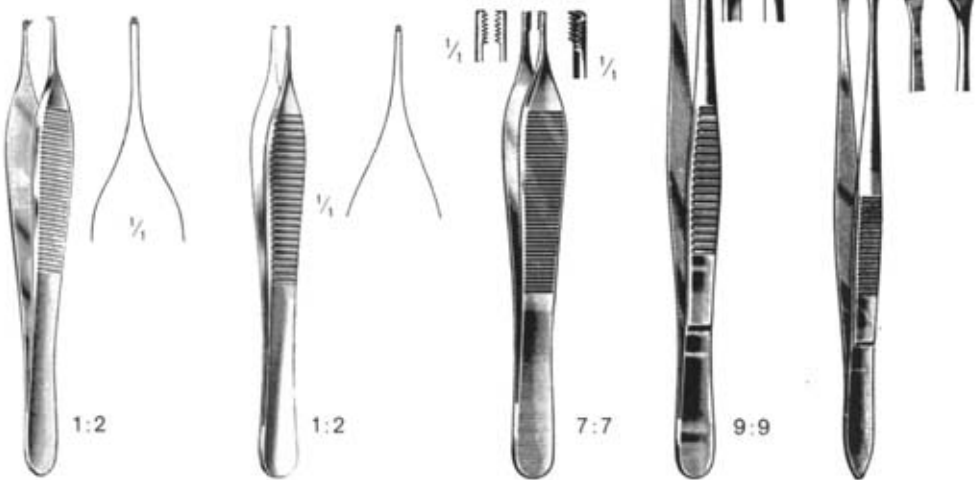

cm	ADSON	ADSON micro	ADSON-BROWN	BROWN	GRAEFE
10,5					M10.190.10
12,0	M10.180.12	M10.186.12			
15,0	M10.180.15				
16,0				M10.189.16	
20,0				M10.189.20	
25,0				M10.189.25	



CUSHING  
M10.230.17  
17 cm

Pinzetten  
Thumb and Tissue Forceps  
Pincés à dissection  
Pinzas de disección  
Pinze per dissezione

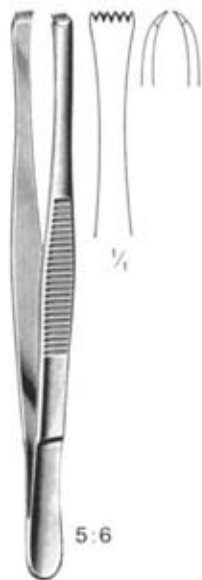

5:6

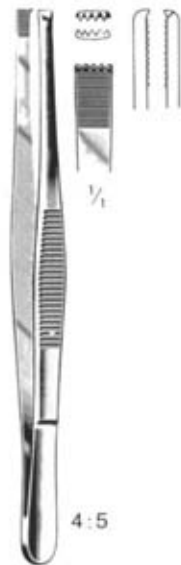

4:5



1:2



2:3



1:2



2:3

cm LERCHE  
14,5  
15,0 M10.223.15  
18,0  
20,0

ADLERKREUTZ  
M10.236.15  
M10.236.20

LANE  
M10.240.14

LANE  
M10.242.14

FERRIS-SMITH  
M10.246.18

FERRIS-SMITH  
M10.248.18



cm DUVAL  
14,5 M10.250.14  
15,0  
20,0  
25,0



COLLIN-DUVAL  
M10.252.14















Russ. Mod.  
M10.256.15  
M10.256.20  
M10.256.25



MxINDOE  
M10.258.15

Pinzetten  
Thumb and Tissue Forceps  
Pinces à dissection  
Pinzas de disección  
Pinze per dissezione

								
cm	SEMKEN	GERALD	GERALD	GERALD				
12,5	M10.260.12	M10.302.18	M10.303.18	M10.305.18				
15,5	M10.260.15							
18,0								
								
cm	SEMKEN	GILLIES	GERALD	GERALD	GERALD	SINGLEY	NELSON	WANGENSTEEN
12,5	M10.270.12		M10.310.18	M10.311.18	M10.313.18	M10.320.23	M10.322.23	M10.324.23
15,5	M10.270.15	M10.272.15						
18,0								
23,0								

Splitterpinzetten, -zangen  
 Splinter Forceps  
 Pincès à échardes  
 Pinzas para espinas  
 Pinze per schegge

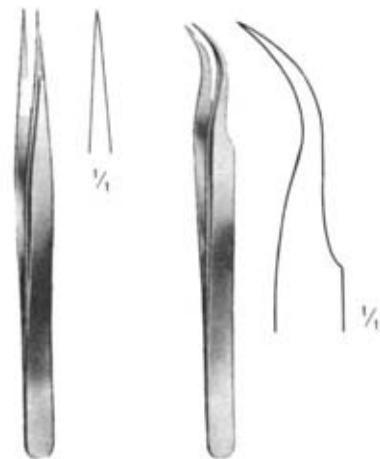

M10330.12  
12 cm

M10.331.12  
10 cm

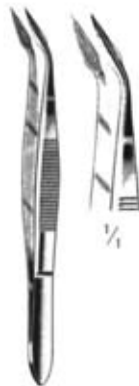

cm  
 7,5  
 9,0 M10.802.09  
 10,5  
 11,5 M10.802.11 M10.810.11  
 12,5

FELCHENFELD  
M10.810.07

HUNTER

M10.812.10

HUNTER

M10.813.10

CARMALT

M10.816.10

CARMALT

M10.817.10

M10.815.12



PEET  
M10.821.11  
11,5 cm



STIEGLITZ  
M10.822.13 13,5 cm M10.823.13



ARCHER  
M10.824.14 14 cm M10.825.14



VIRTUS (RALK)  
M10.828.15  
15 cm

Mikrochirurgie-Pinzetten  
Microsurgery Forceps  
Pinces à microchirurgie  
Pinzas para microcirugía  
Pinze per microchirurgia



M11.102.12 12 cm M11.103.12



M11.104.15 15 cm M11.105.15



M11.108.18 18 cm M11.109.18

Atraumatische Pinzetten  
 Atraumatic Tissue Forceps  
 Pincès atraumatiques  
 Pinzas atraumáticas  
 Pinze atraumatiche

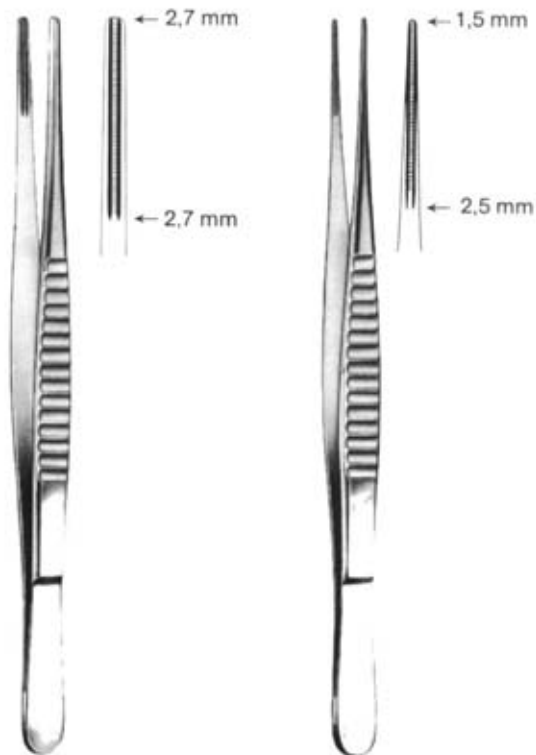

cm	DEBAKEY	DE BAKEY
16	M11.304.16	M11.306.16
20	M11.304.20	M11.306.20
24	M11.304.24	M11.306.24
30	M11.304.30	

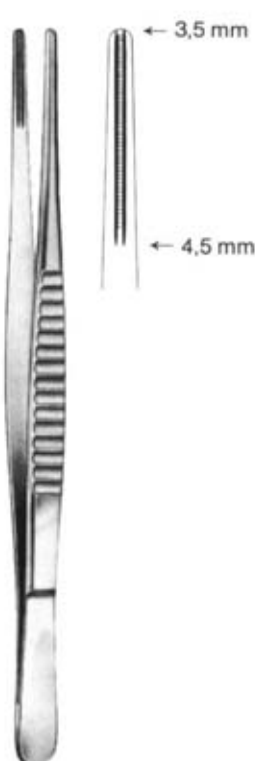
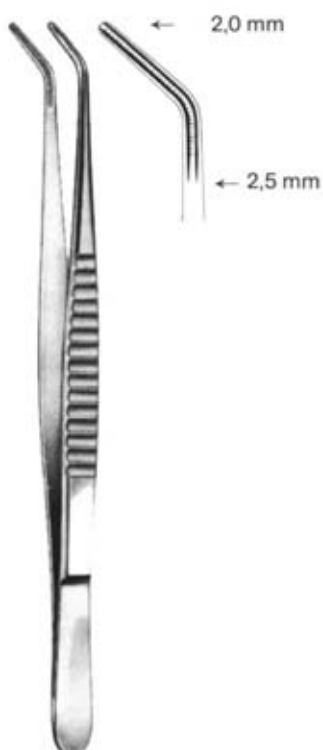

cm	DE BAKEY	DE BAKEY	DE BAKEY	COOLEY
16	M11.308.16	M11.309.16	M11.310.16	M11.314.16
20	M11.308.20	M11.309.20	M11.310.20	M11.314.20
24	M11.308.24	M11.309.24	M11.310.24	
30	M11.308.30	M11.309.30	M11.310.30	

Atrauma-Bulldogklemmen  
Atrauma Bulldog Clamps  
Clamps Bulldog Atrauma  
Clamps Atrauma Bulldog  
Pinze Atrauma Bulldog



**DE BAKEY**  
M12.092.07-M12.093.12

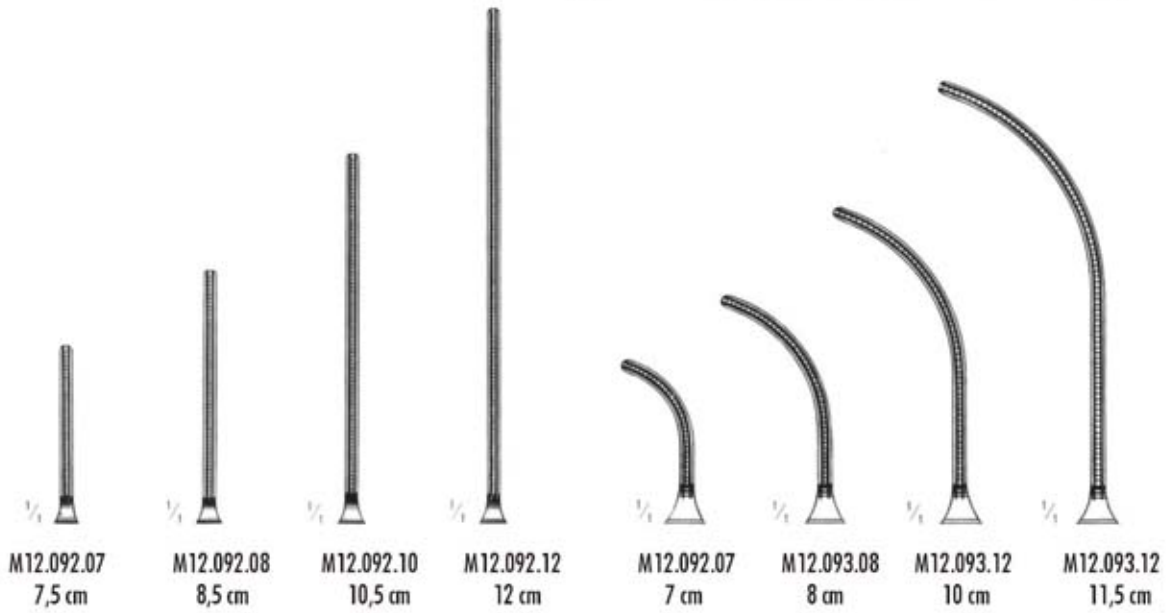

**CLOVER**  
M12.096.06-M12.097.11

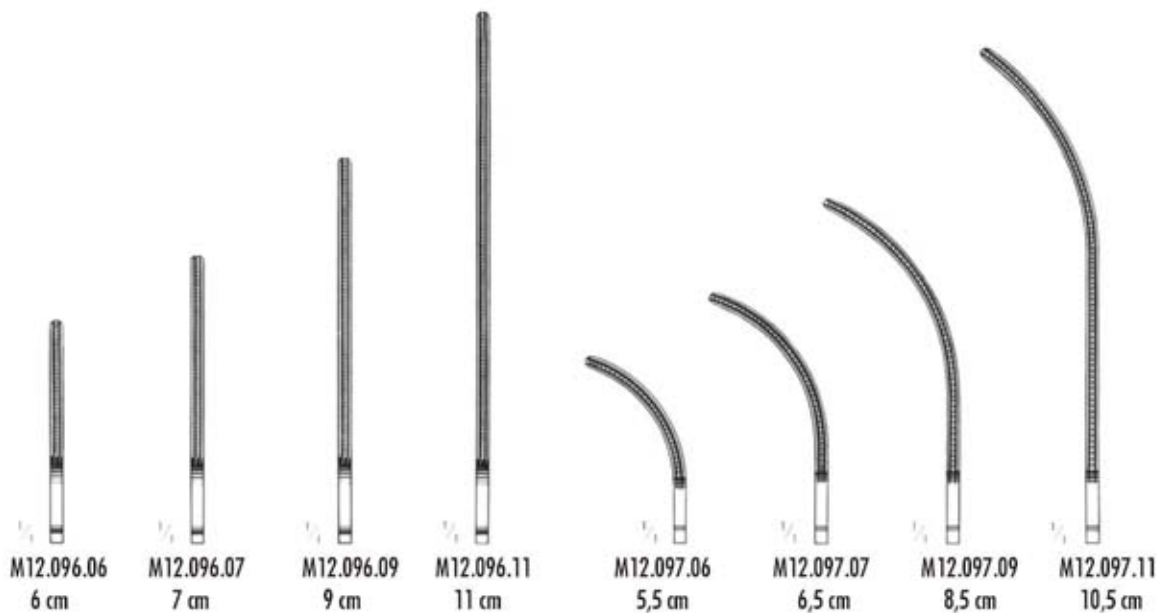

Arterienklemmen  
 Hemostatic Forceps  
 Pinces hémostatiques  
 Pinzas hemostáticas  
 Pinze emostatiche

Gefäßklemmen  
 Serrefines  
 Serre-fines  
 Serra-finas  
 Serrefine



cm	DIEFFENBACH		JOHNS-HOPKINS	
3,5	M12.102.04	M12.103.04		
5,0			M12.110.50	M12.111.50
5,5	M12.102.05	M12.103.05	M12.110.55	M12.111.55
6,5			M12.110.65	M12.111.65
7,0			M12.110.70	M12.111.70
7,5			M12.110.75	M12.111.75
9,0			M12.110.75	M12.111.90





Titan  
Titanium  
Titane  
Titanio

Arterienklemmen  
Hemostatic Forceps  
Pinces hémostatiques  
Pinzas hemostáticas  
Pinze emostatiche

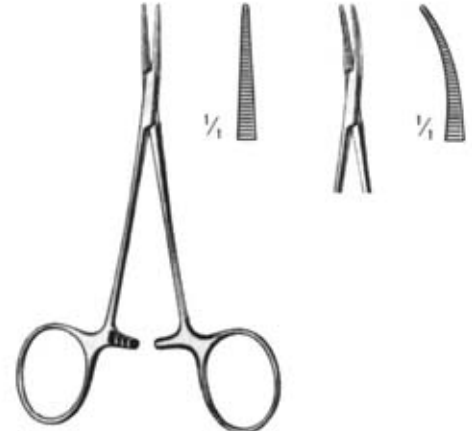

cm		HALSTED - MOSQUITO			HALSTED-MOSQUITO micro	
12,5	<b>M12.224.12</b>	M12.220.12	M12.221.12	<b>M12.225.12</b>	M12.222.12	M12.223.12
14,0		M12.221.14	M12.221.14			
18,0		M12.221.18	M12.221.18			
21,0		M12.220.21	M12.221.21			

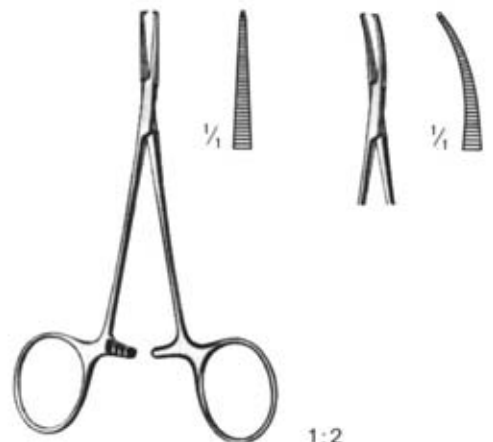

cm		HALSTED - MOSQUITO			HALSTED - MOSQUITO micro	
12,5	<b>M12.234.12</b>	M12.230.12	M12.231.12	<b>M12.235.12</b>	M12.231.12	M12.233.12
14,0		M12.230.14	M12.231.14			
18,0		M12.230.18	M12.231.18			
21,0		M12.230.21	M12.231.21			

Arterienklemmen  
 Hemostatic Forceps  
 Pinces hémostatiques  
 Pinzas hemostáticas  
 Pinze emostatiche

Titan  
 Titanium  
 Titane  
 Titanio

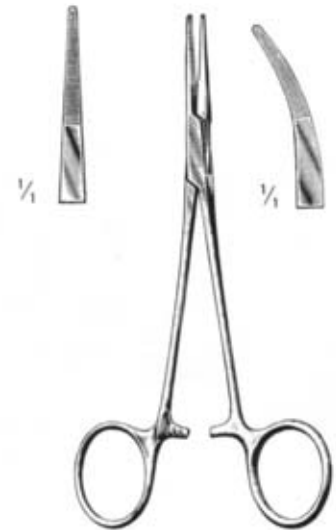
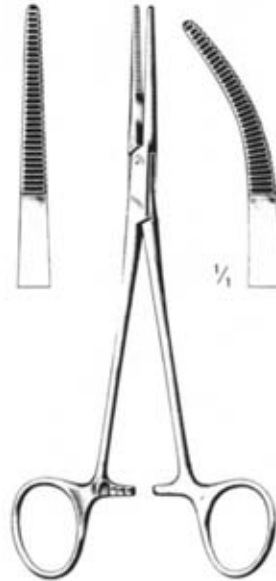
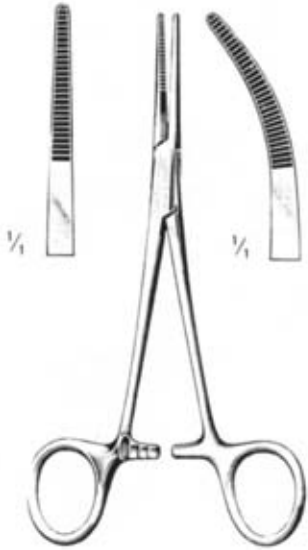

cm	KELLY		KELLY-RANKIN		PROVIDENCE-HOSPITAL	
14	M12.240.14	M12.241.14			M12.270.14	M12.271.14
14	M12.244.14	M12.245.14				
16			M12.242.16	M12.243.16		

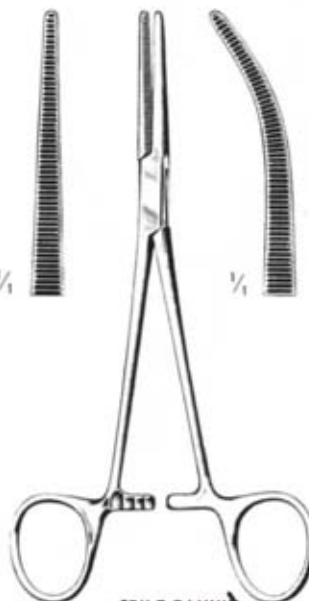
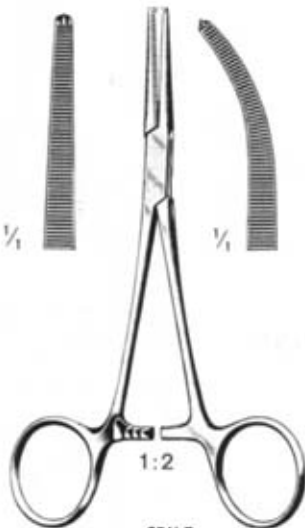
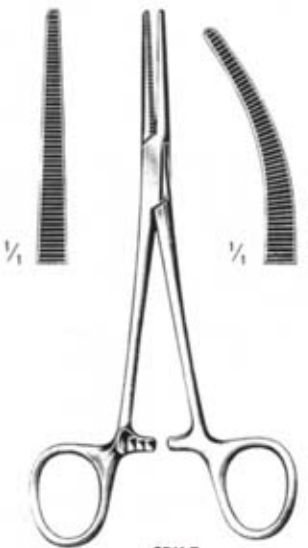

cm	CRILE		CRILE		CRILE-RANKIN		CRILE-RANKIN	
14	M12.250.14	M12.251.14	M12.260.14	M12.261.14				
14	M12.254.14	M12.255.14						
16					M12.262.16	M12.264.16	M12.264.16	M12.265.16

Arterienklemmen  
Hemostatic Forceps  
Pinces hémostatiques  
Pinzas hemostáticas  
Pinze emostatiche

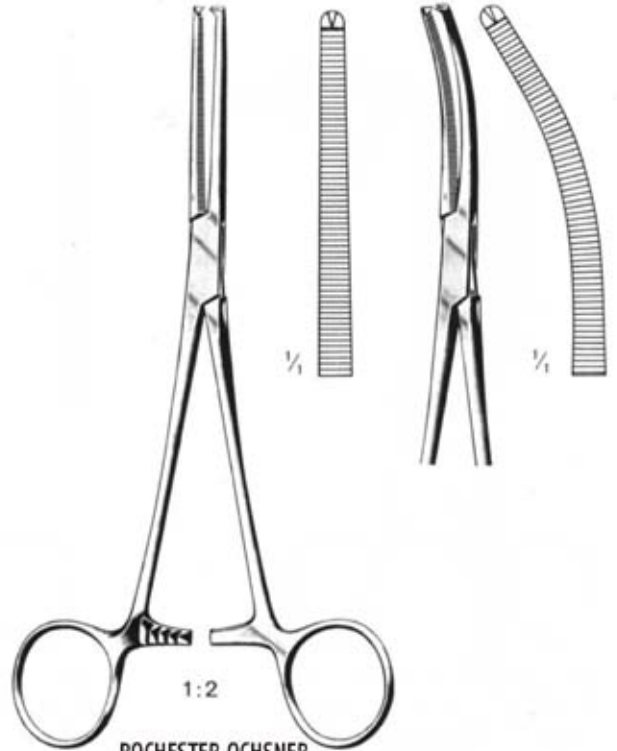
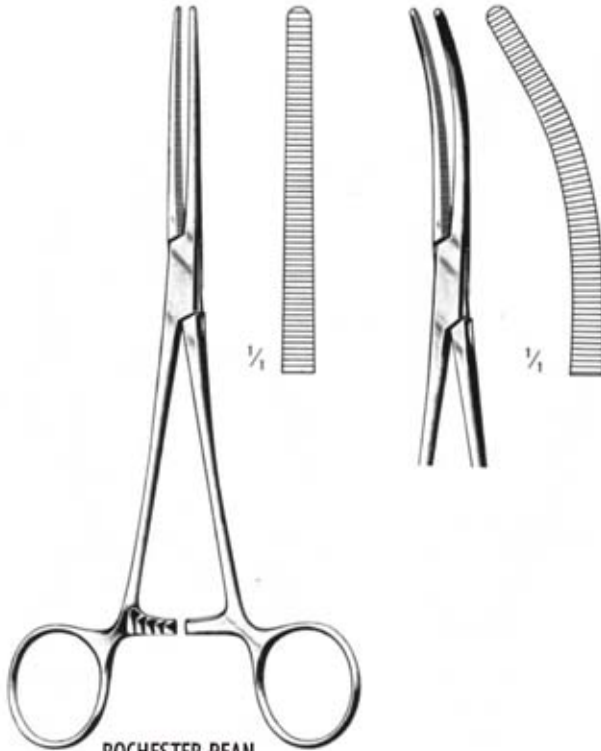

cm	ROCHESTER-PEAN		ROCHESTER-OGHSNER	
13	M12.310.13	M12.311.13	M12.320.13	M12.321.13
14	M12.310.14	M12.311.14	M12.320.14	M12.321.14
16	M12.310.16	M12.311.16	M12.320.16	M12.321.16
18	M12.310.18	M12.311.18	M12.320.18	M12.321.18
20	M12.310.20	M12.311.20	M12.320.20	M12.321.20
22	M12.310.22	M12.311.22	M12.320.22	M12.321.22
24	M12.310.24	M12.311.24	M12.320.24	M12.321.24
26	M12.310.26	M12.311.26	M12.320.26	M12.321.26
30	M12.310.30	M12.311.30	M12.320.30	M12.321.30



Graziles Modell  
Delicate Model  
Modele delicat  
modelo delgado  
modello delicato

PEAN  
M12.312.14 14 cm M12.313.14

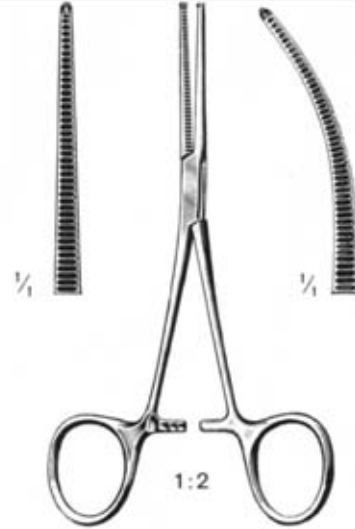

Graziles Modell  
Delicate Model  
Modele delicat  
modelo delgado  
modello delicato

KOCHER  
M12.322.14 M12.323.14

Arterienklemmen  
Hemostatic Forceps  
Pincès hémostatiques  
Pinzas hemostáticas  
Pinze emostatiche



SPENCER - WELLS

M12.330.13	13 cm	M12.331.13
M12.330.15	15 cm	M12.331.15
M12.330.18	18 cm	M12.331.18
M12.330.20	20 cm	M12.331.20

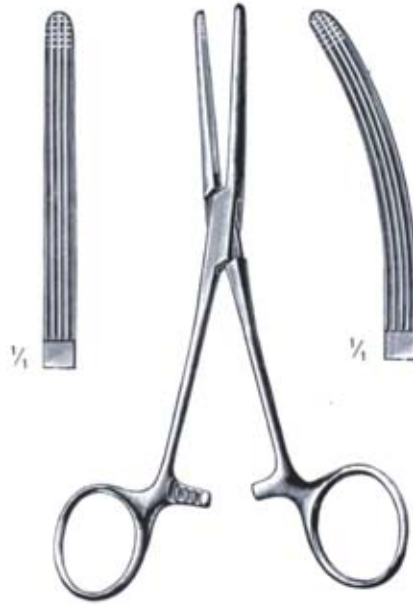

ROCHESTER-CARMALT

M12.340.16	16 cm	M12.341.16
M12.340.20	20 cm	M12.341.20

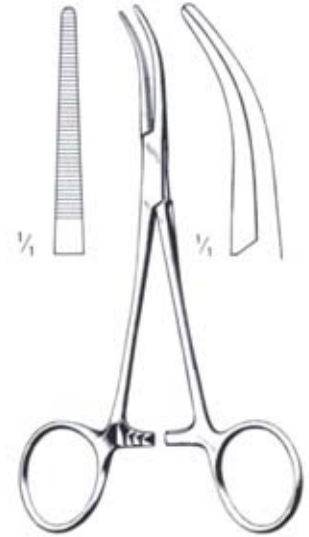

DANDY

M12.345.14	14 cm
------------	-------



FERGUSSON

M12.350.16	16 cm	M12.351.16
M12.350.20	20 cm	M12.351.20

Druckklemmen . Angiotribes  
Pincès-clamps a pression  
progressive . Pinzas-damps  
para presion progresiva  
Angiotribi



LOVELACE

M12.356.15	15,5 cm
------------	---------



PENNINGTON

cm	M12.358.15
15,5	M12.358.20
20,0	

Arterienklemmen  
Hemostatic Forceps  
Pinces hémostatiques  
Pinzas hemostáticas  
Pinze emostatiche



PRATT  
M12.360.15  
15 cm



MARTELL  
M12.364.14  
14 cm



WILLET-MARTEL  
M12.366.19  
19 cm

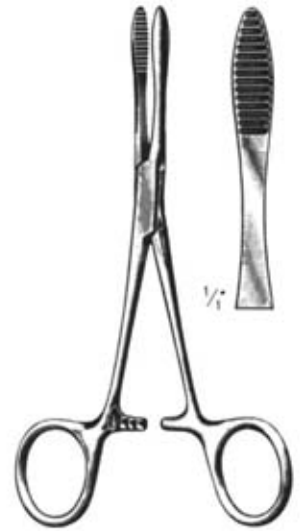

cm PEAN  
14 M12.368.14  
16 M12.368.16

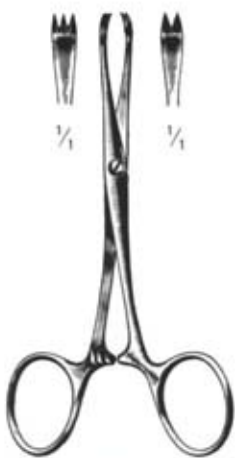

CHAPUT  
M12.370.13  
13 cm



TUFFIER  
M2.372.13  
13 cm



COLLIN  
M12.347.14  
14 cm



COLLIN  
M12.376.16  
16 cm

Arterienklemmen  
Hemostatic Forceps  
Pincès hémostatiques  
Pinzas hemostáticas  
Pinze emostatiche

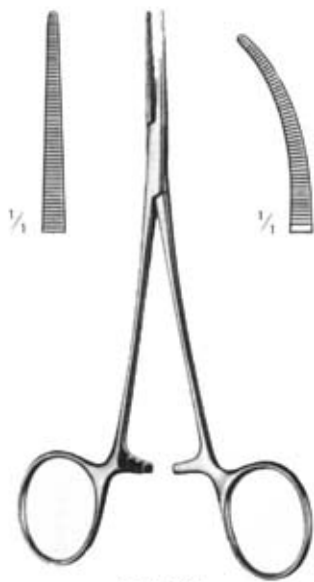

**LERICHE**  
M12.380.15 15 cm M12.381.15

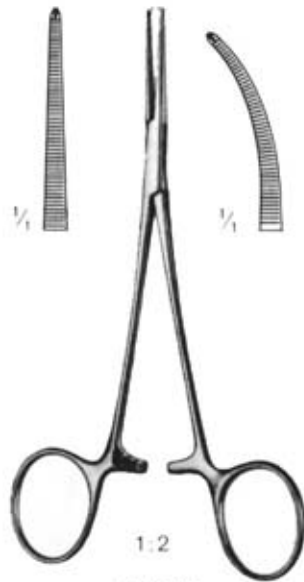

**LERICHE**  
M12.382.15 15 cm M12.383.15

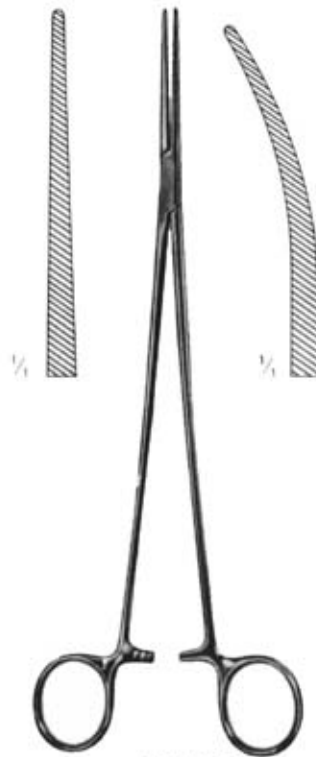

**BENGOLEA**  
M12.384.20 20 cm M12.385.20  
M12.384.26 26 cm M12.385.26

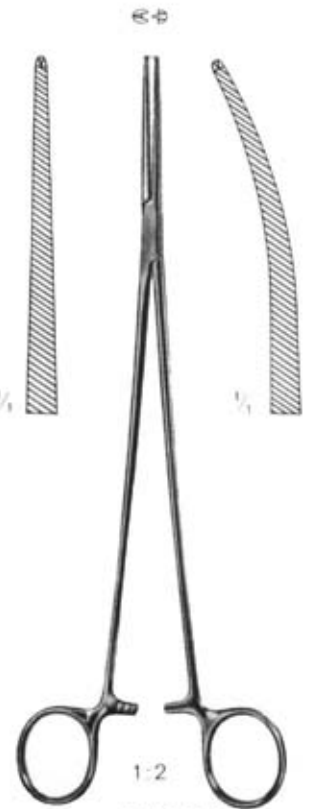

**BENGOLEA**  
M12.386.20 20 cm M12.387.20  
M12.386.26 26 cm M12.387.26

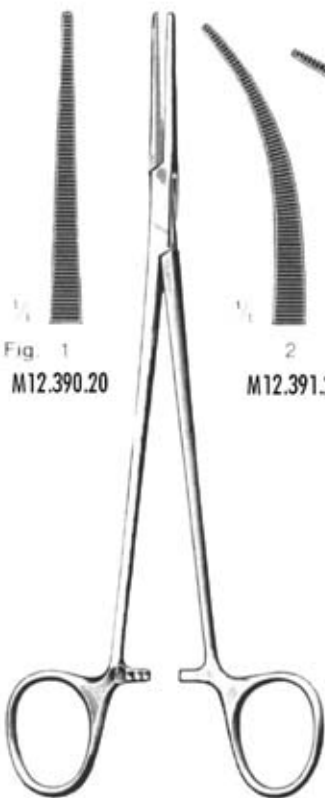

Fig. 1  
M12.390.20

**HEISS**  
20cm



2 M12.391.20  
3 M12.393.20



**ADSON**  
M12.410.18 18,5cm M 12.411.18

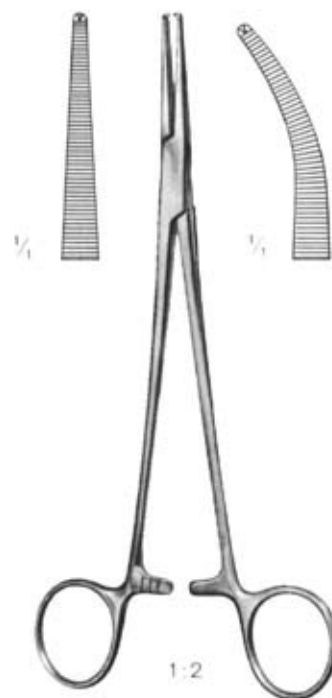

**ADSON**  
M12.412.18 18,5cm M12.413.18



**ADSON Baby**  
M12.415.18

Arterienklemmen  
Hemostatic Forceps  
Pincès hémostatiques  
Pinzas hemostáticas  
Pinze emostatiche



OVERHOLT-GEISSENDOERFER  
M12.421.01-M12.427.08

Präparier- und Ligaturklemmen  
Dissecting and Ligature Forceps  
Pincès à dissection et à ligatures  
Pinzas para disección y ligaduras  
Pinze per dissezione e per legature (Passafili)

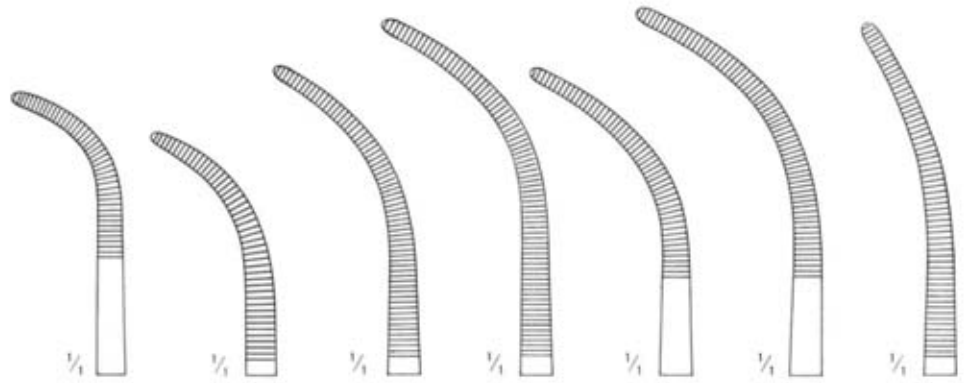

cm	Fig. 1	Fig. 2	Fig. 3	Fig. 4	Fig. 5	Fig. 6	Fig. 7
21	M12.421.01	M12.421.02	M12.421.03	M12.421.04	M12.421.05	M12.421.06	M12.421.07
27	M12.427.01	M12.427.02	M12.427.03	M12.427.04	M12.427.05	M12.427.06	M12.427.07



GEMINI  
GEMINI mini

cm	Fig. 1	Fig. 2	Fig. 3	Fig. 4	Fig. 5	Fig. 6	Fig. 7
18	M12.433.18	M12.443.22	M12.433.25	M12.433.28			
13 cm	GEMINI M12.431.13	M12.431.16	M12.431.18	M12.431.20	M12.431.23	M12.431.25	M12.431.28
	13 cm	16 cm	18 cm	20 cm	23 cm	25 cm	28 cm

Arterienklemmen  
 Hemostatic Forceps  
 Pincès hémostatiques  
 Pinzas hemostáticas  
 Pinze emostatiche



1/4  
 M12.441.01

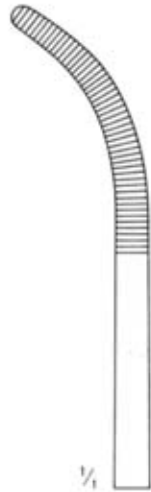

1/4  
 M12.441.02

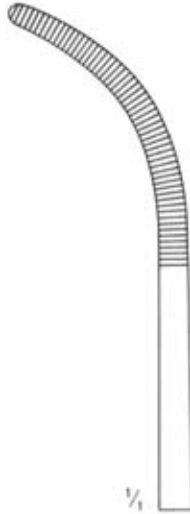

1/4  
 M12.441.03

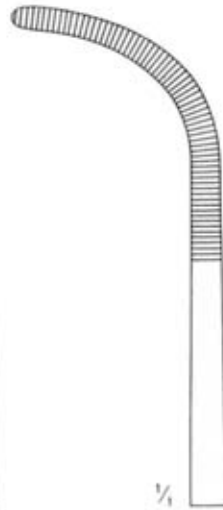

1/4  
 M12.441.04



RUMEL  
 M12.442.01 - M12.441.04  
 23 cm



1/4  
 M12.442.21 21 cm  
 M12.442.26 26 cm



1/4  
 21 cm M12.443.21  
 26 cm M12.443.26



1/4 1:2  
 M12.444.21 21 cm  
 M12.444.26 26 cm



1/4 1:2  
 21 cm M12.445.21  
 26 cm M12.445.26



TOENNIS  
 M12.442.21 - M12.445.26  
 21 cm 26 cm

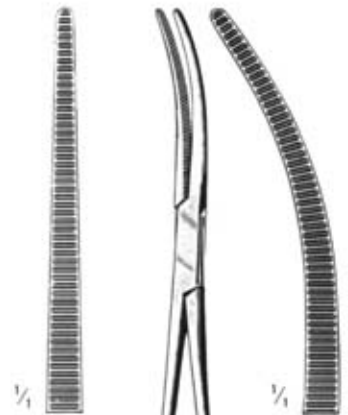

1/4

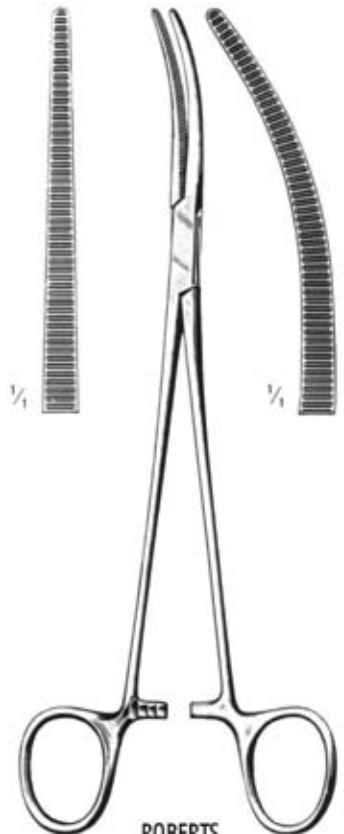

ROBERTS  
 M12.448.22 22 cm M12.449.22



Arterienklemmen  
Hemostatic Forceps  
Pinces hémostatiques  
Pinzas hemostáticas  
Pinze emostatiche

Bronchusklemmen  
Bronchus Forceps  
Pinces-Clamps à Bronches  
Pinzas clamps bronquiales  
Pinze per bronchi

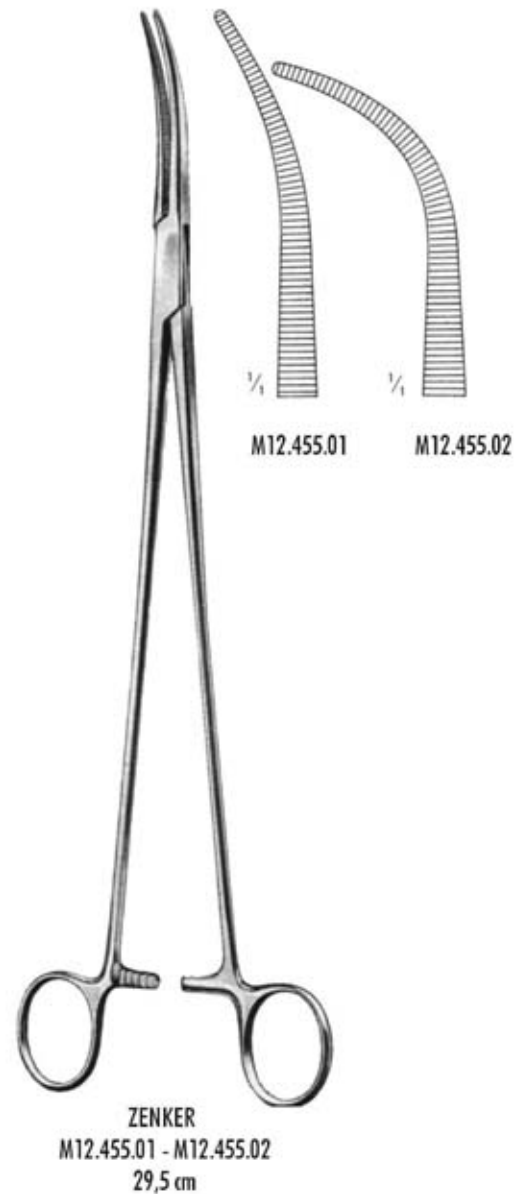
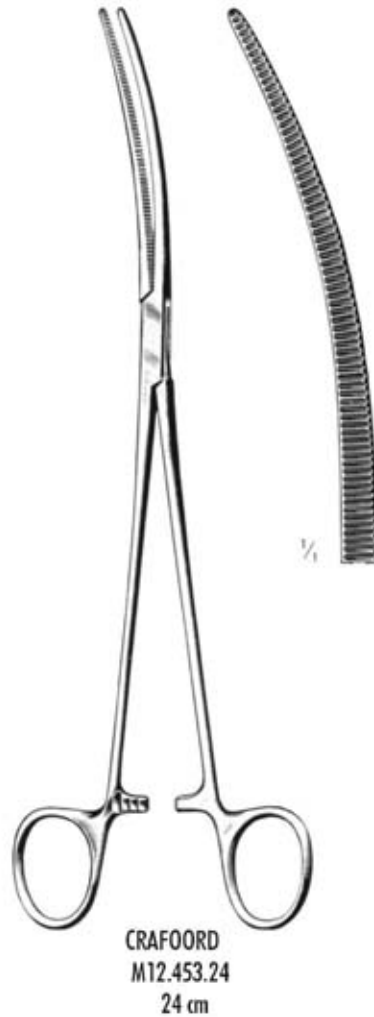
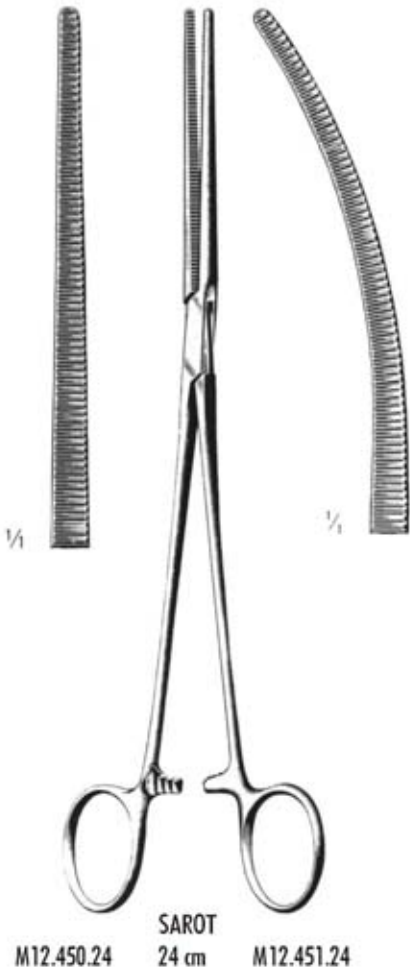

Arterienklemmen  
Hemostatic Forceps  
Pinces hémostatiques  
Pinzas hemostáticas  
Pinze emostatiche



LAWRENCE  
M12.475.28  
28 cm



MEEKER  
M12.459.28  
28 cm



cm	MIXTER
14	M12.471.14
16	M12.471.16
18	M12.471.18
23	M12.471.23



MIXTER  
M12.473.22  
22 cm



MIXTER Baby  
M12.475.14  
14 cm



MIXTER Baby  
M12.475.18  
18 cm

Arterien, Gallenkanal, Nierenstiel  
Hemostatic, Gall Duct, and Kidney Pedicle  
Hémostatiques, pédicule rénal et voies biliaires  
Hemostáticas, pediculo renal y vias biliares  
Emostatiche, pedunculo renale e vie biliari

Arterienklemmen  
Hemostatic Forceps  
Pinces hémostatiques  
Pinzas hemostáticas  
Pinze emostatiche

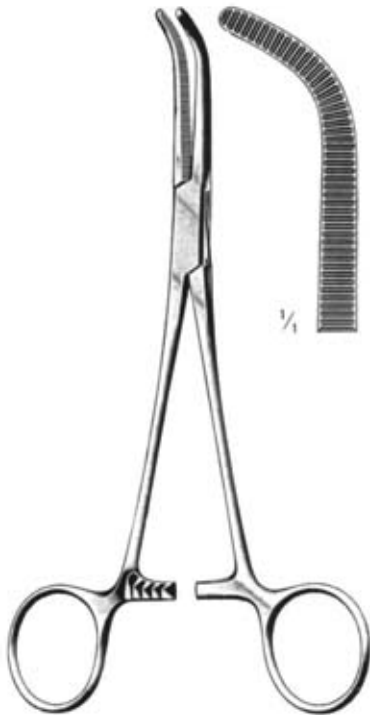

cm **MIXTER-O'SHAUGHNESSY**  
15,5 M12.477.15  
cm M12.477.19



**MIXTER**  
M12.47.22 - M12.479.28

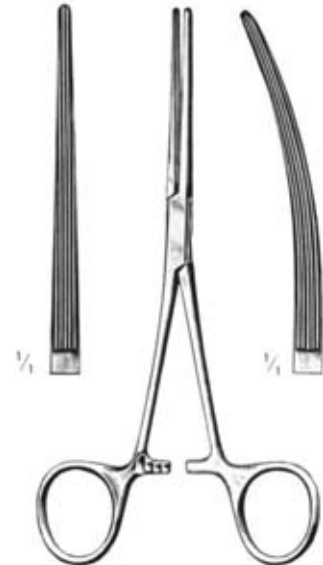
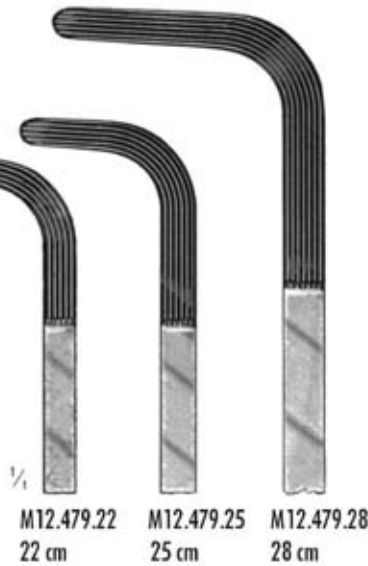

**BAINBRIDGE**  
M12.480.15 15,0 cm M12.481.15  
M12.490.18 18,5 cm M12.481.18

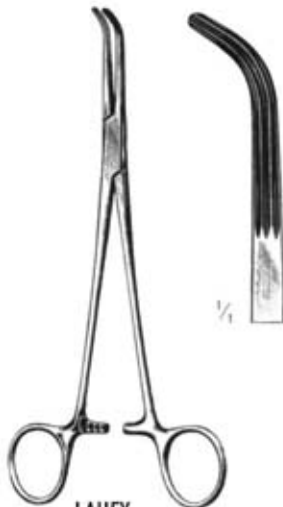

**LAHEY**  
M12.491.19  
19 cm



**LAHEY**  
M12.493.23  
23 cm



**LOWER**  
M12.495.18  
18 cm

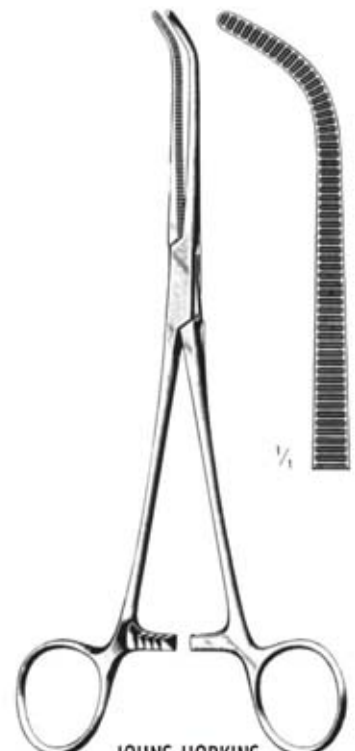

**JOHNS-HOPKINS**  
M12.497.20  
20 cm

Arterienklemmen  
Hemostatic Forceps  
Pinces hémostatiques  
Pinzas hemostáticas  
Pinze emostatiche

Gallenkanal - Gall Duct .  
Coies biliaires . Vias  
biliares . Vie biliari



MIXTER  
M12.499.16  
16,5 cm



MOYNIHAN  
M12.501.23  
23 cm



DESJARDINS  
M12.503.21  
21 cm



DESJARDINS  
M12.505.21  
21 cm

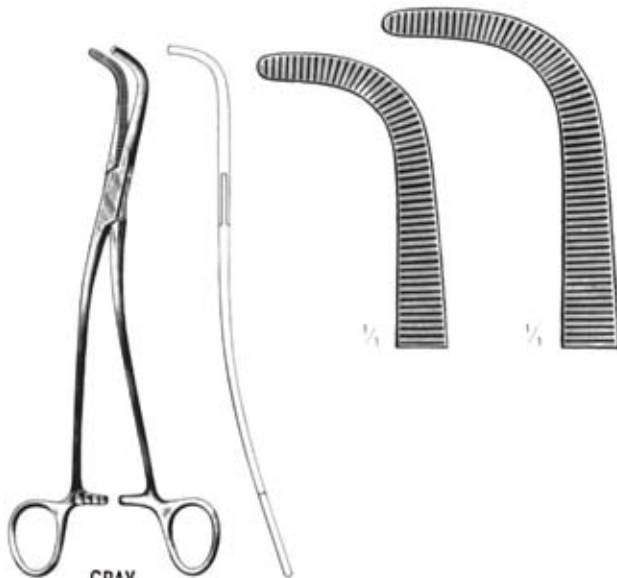

GRAY

M12.507.22  
22 cm      M12.507.23  
23 cm

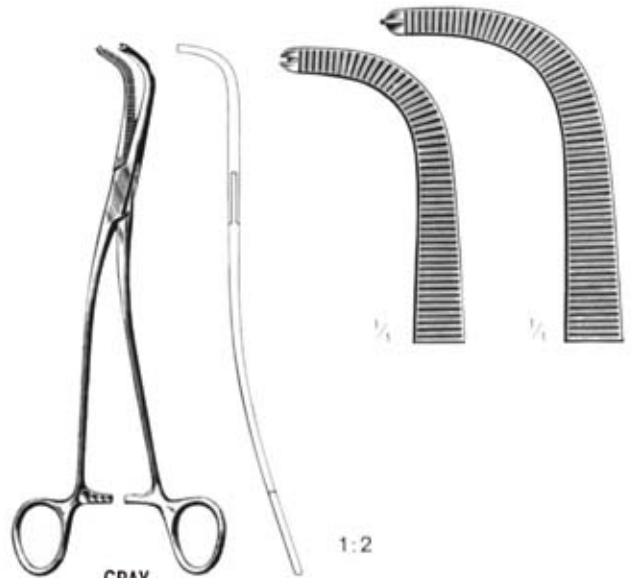

GRAY

M12.509.22  
22 cm      M12.509.23  
23 cm

Arterienklemmen  
Hemostatic Forceps  
Pinces hémostatiques  
Pinzas hemostáticas  
Pinze emostatiche

Nierenstel, Gallenkanal  
Kidney Pedicle, Gall Duct  
Pedicule renal, conduit biliare  
Pediculo renal, vias biliare  
Pedundulo renale, vie biliari

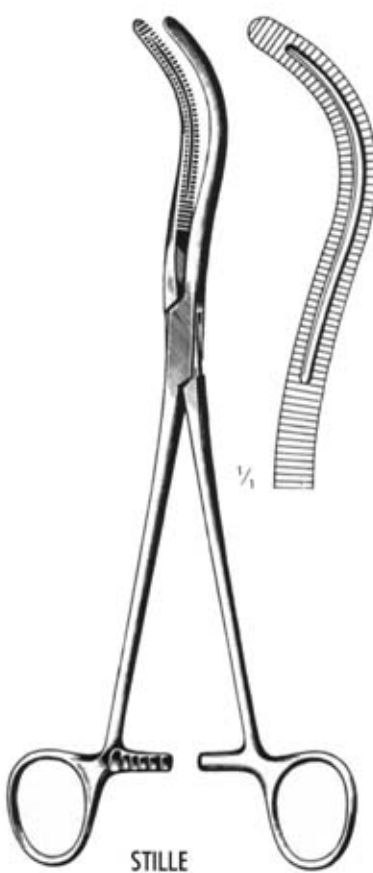

STILLE  
M12.513.23  
23 cm

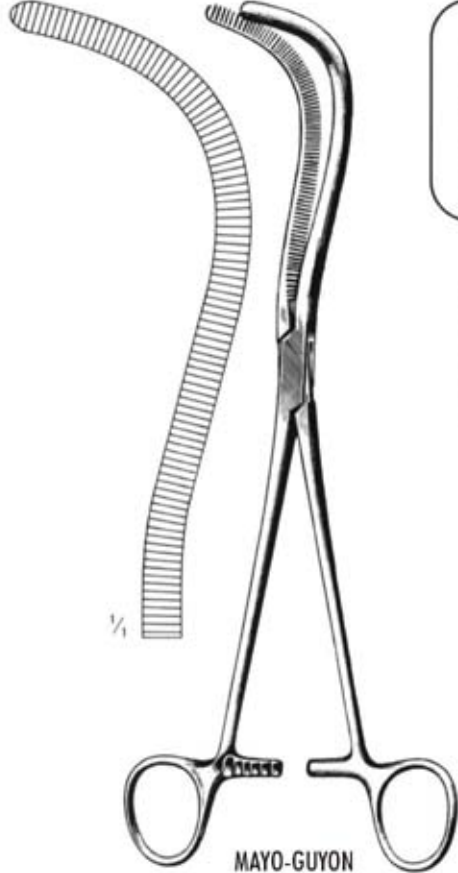

MAYO-GUYON  
M12.515.23  
23 cm

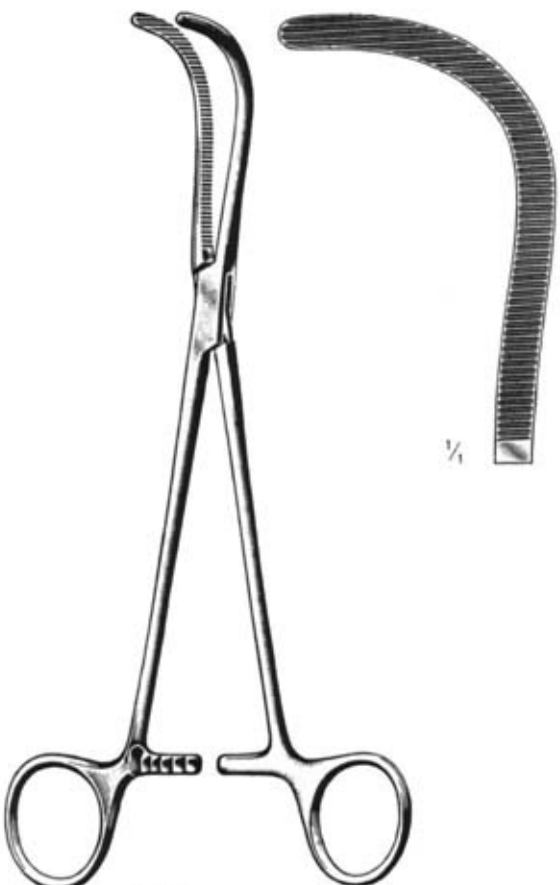

GUYON  
M12.517.23  
23 cm

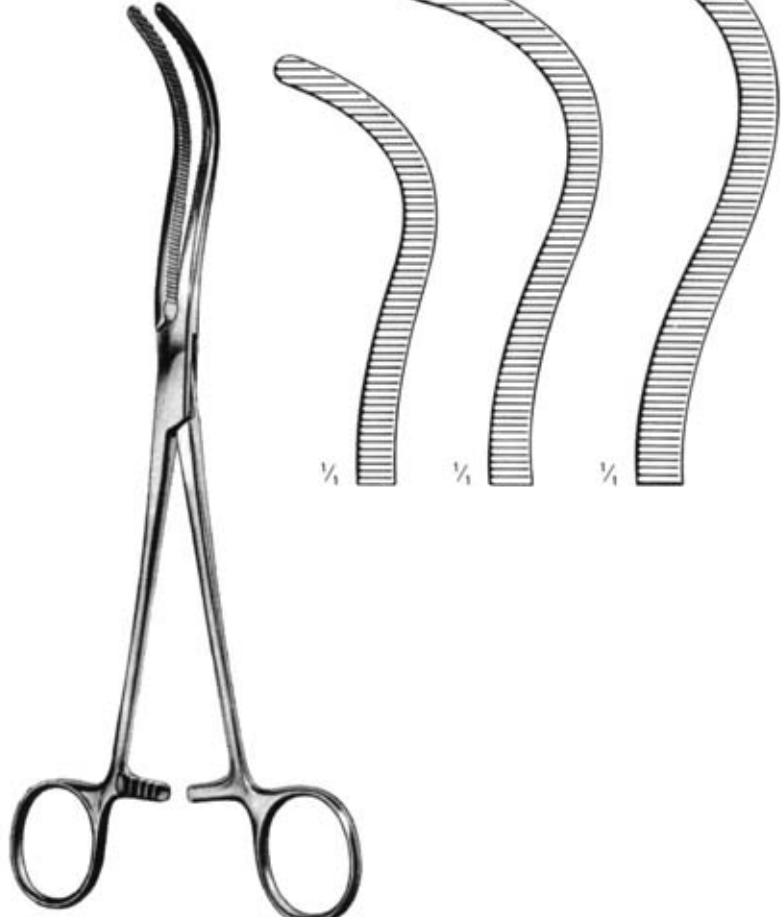

GUYON

M12.519.20  
20 cm

M12.519.22  
22 cm

M12.519.24  
24 cm

Arterienklemmen  
Hemostatic Forceps  
Pinces hémostatiques  
Pinzas hemostáticas  
Pinze emostatiche

Nierenstiel  
Kidney Pedicle  
Pédicule rénal  
Pediculo renal  
Pedunculo renale

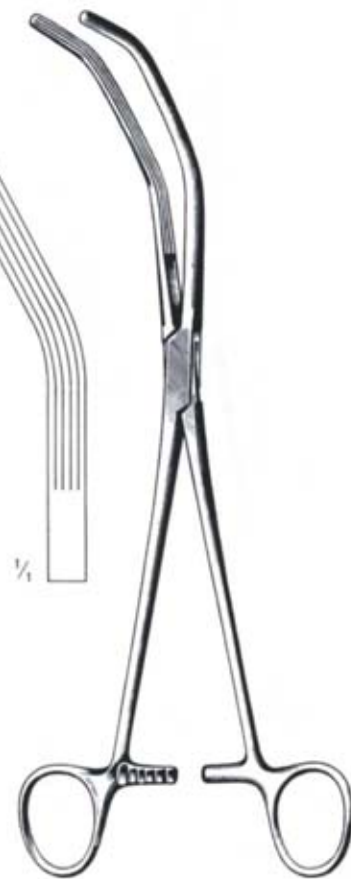

HERRICK  
M12.523.23  
23 cm

Peritoneum-Klemmen  
Peritoneum Forceps  
Pinces à péritoine  
Pinzas para peritoneo  
Pinze peritoneali



MIKULICZ  
M12.551.20  
20 cm



PHANEUF  
M12.554.21 21 cm M12.555.21

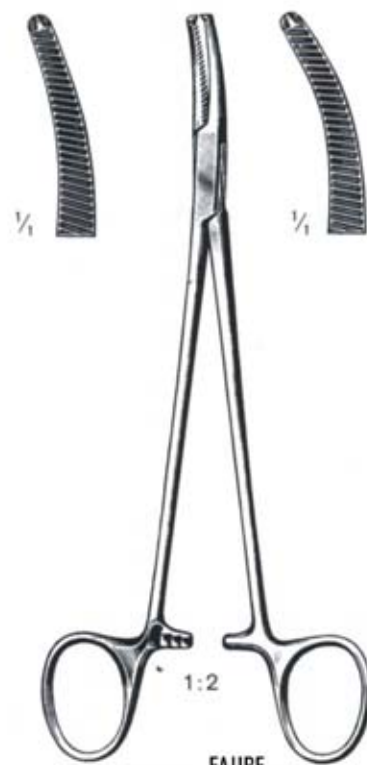

FAURE  
M12.561.20 20 cm M12.563.20

Hysterektomie-Klemmen  
Hysterectomy Forceps  
Pinces à hysterectomie  
Pinzas para hysterectomía  
Pinze per isterectomia



WERTHEIM  
M12.571.25  
25 cm



WERTHEIM  
M12.573.22 22 cm  
M12.573.23 23 cm



WERTHEIM-CULLEN  
M12.579.21  
21,5 cm



HEANEY  
20 cm M12.591.20 M12.593.20

Schlauchklemmen  
 Tubing Clamps  
 Pincas serre-tubes  
 Pinzas cierra-tubos  
 Pinze serretubi

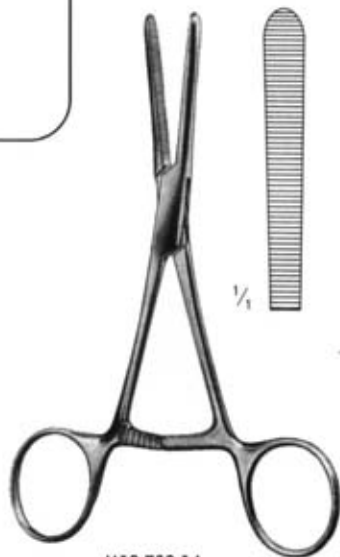

M12.702.14  
 14,5 cm

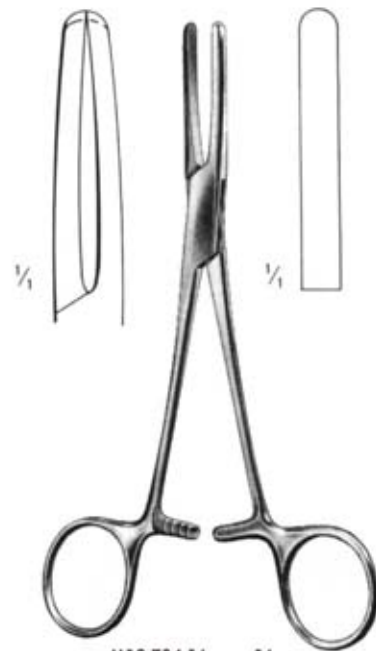

M12.704.16 16 cm  
 M12.704.18 18 cm



M12.710.15-M12.710.20



M12.710.15  
 15 cm



M12.710.18  
 18 cm



M12.710.20  
 20 cm



M12.712.15-M12.712.20



M12.712.15  
 15 cm



M12.712.18  
 18 cm



M12.712.20  
 20 cm



Tuchklemmen  
Towel Forceps  
Pincès à champs  
Pinzas para campos  
Pinze fissateli



SCHAEDEL  
M14.101.09  
9 cm



JONES  
M14.103.09  
9 cm



JONES-CLIP  
M14.105.09  
9 cm

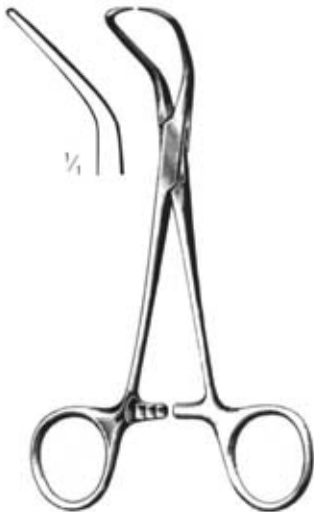

cm	BACKHAUS
9	M14.111.09
11	M14.111.11
13	M14.111.13
15	M14.111.15



BACKHAUS-CLIP  
M14.15.11  
11 cm



ROEDER  
M14.117.13  
13 cm



cm	LORNA
11	M14.121.11
13	M14.121.13



Ball and Socket  
M14.123.13  
13 cm



BERNHARD  
M14.140..16  
16,5 cm



MOYNIHAN  
M14.150.19  
19 cm



DOYEN  
M14.161.18  
18 cm



LANE  
M14.164.20  
20 cm

Tupferzangen  
 Dressing Forceps  
 Pincès à pansements  
 Pinzas para taponés  
 Pinze per medicatura

Korn- und Polypenzangen  
 Dressing an Polypus  
 a polypes et a pansements  
 para polipos  
 per tamponi e polipi

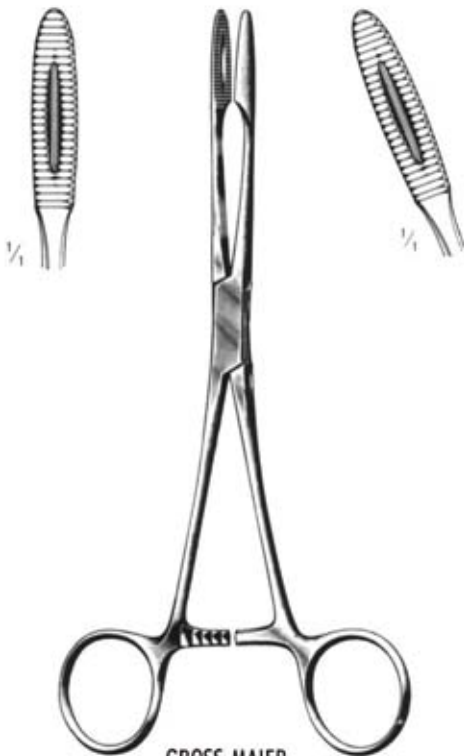

GROSS-MAIER  
 M16.110.20 20 cm M16.111.20  
 M16.110.25 25 cm M16.11.25

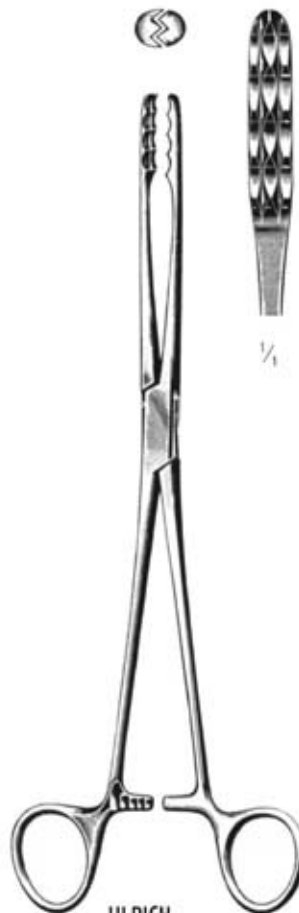

ULRICH  
 M16.160.22 22 cm  
 M16.160.25 25 cm

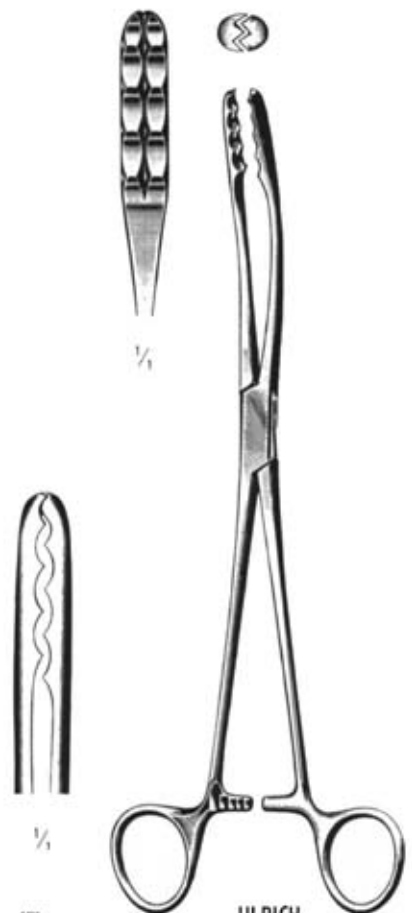

ULRICH  
 M16.161.22 22 cm  
 M16.161.25 25 cm

Schwammzangen  
Sponge Holding Forceps  
Pinces porte-éponges  
Pinzas porta esponjas  
Pinze per tamponi e spugne

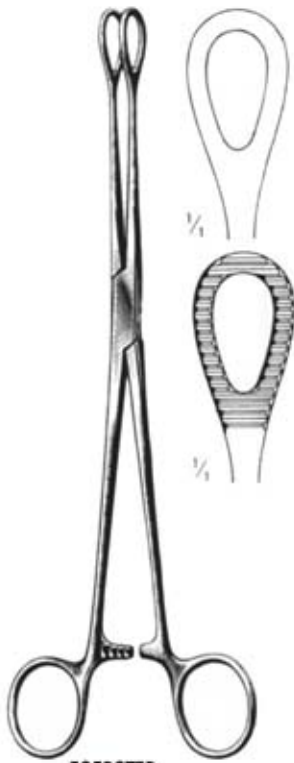

FOERSTER

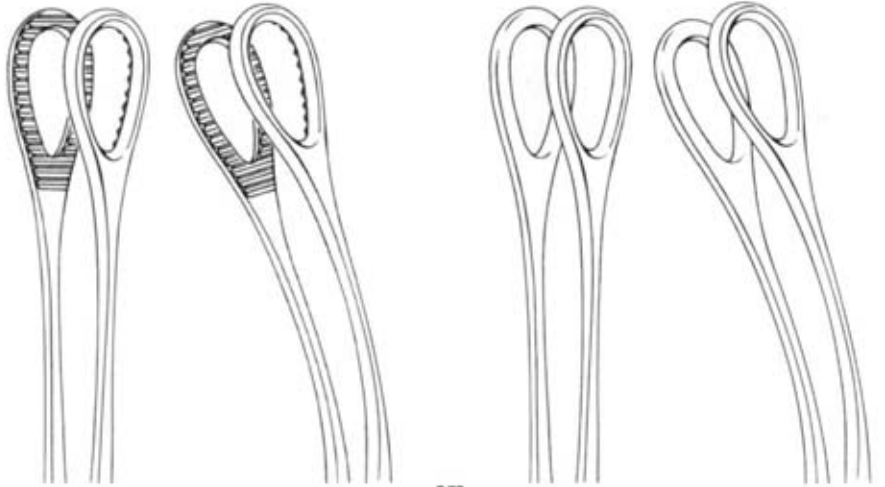

		cm		
M16.170.18	M16.171.18	18	M16.172.18	M16.173.18
M16.170.20	M16.171.20	20		
M16.170.25	M16.171.25	25	M16.172.25	M16.173.25

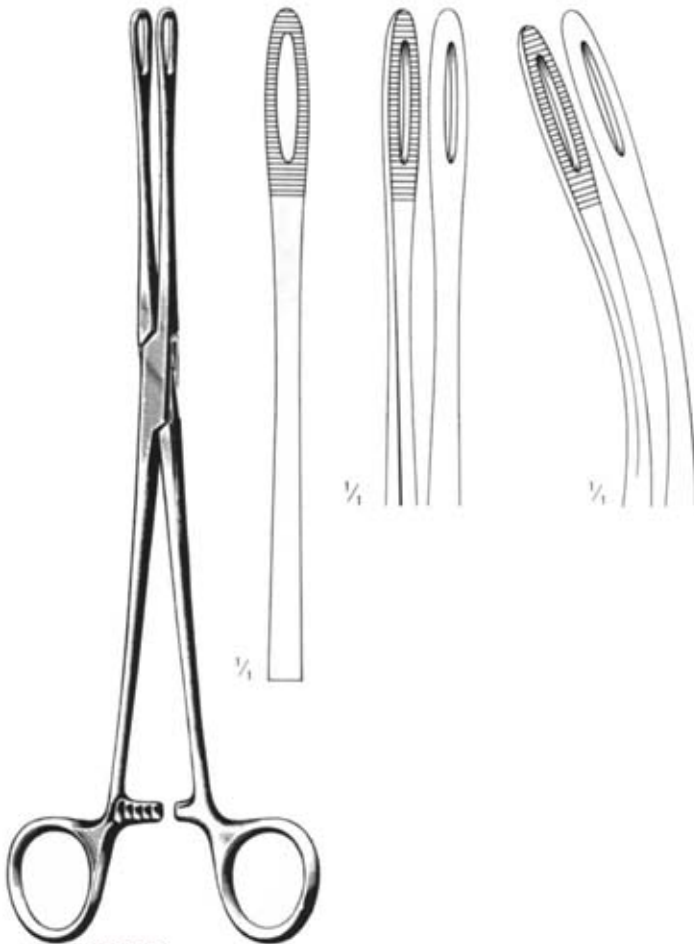

FOERSTER

M16.174.25	M16.175.25
25 cm	25 cm



RAMPLEY  
M16.180.25  
25 cm

Schwammzangen  
Dressing Forceps  
Pinces à polypes  
Pinzas para taponos  
Pinze per tamponi



**BRYANT**  
M16.207.13  
13 cm



cm	LISTER (Sinus)
13	M16.210.13
16	M16.210.16
18	M16.210.18

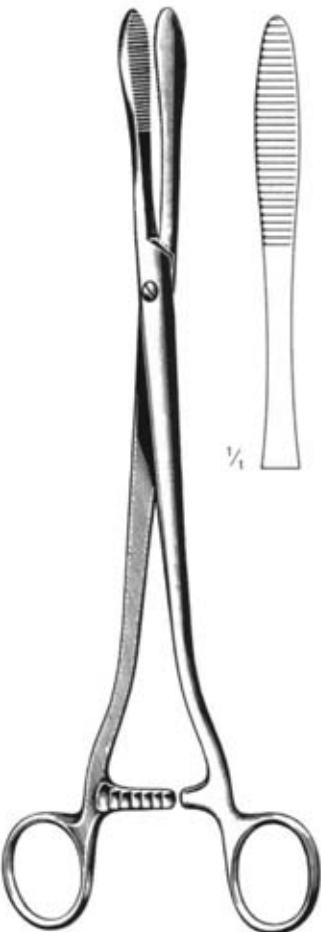

**COLLIN**  
M16.220.25  
25 cm



**PELKMANN**  
M16.226.25  
25 cm



**CHERON**  
M16.229.25  
25 cm

Schwammzangen  
Dressing Forceps  
Pinces à polypes  
Pinzas para tapones  
Pinze per tamponi

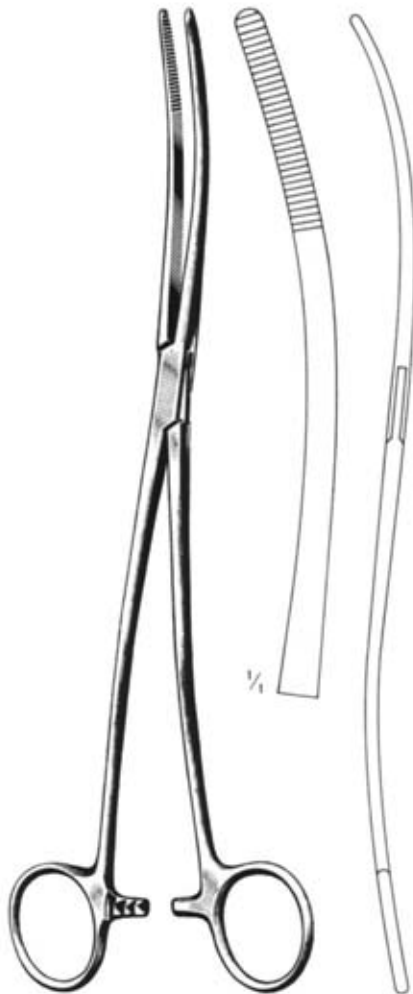

MOZEMANN  
M16.230.26 26 cm M16.231.26

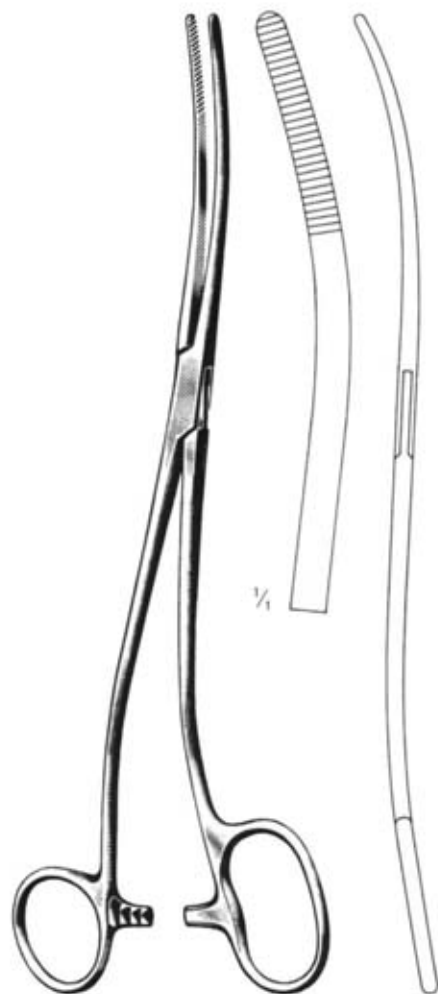

BOZEMANN-DOUGLAS  
M16.233.26  
26 cm

Wundhaken  
Retractors  
Ecarteurs  
Separadores  
Divaricatori

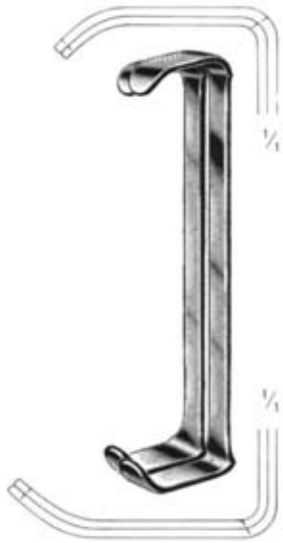

FARABRUF  
M18.102.12  
12 cm



FARABEUF  
M18.102.15  
15 cm

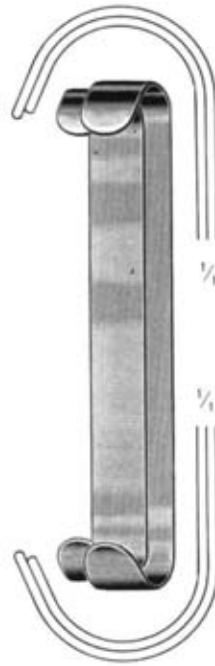

PARKER  
M18.110.13  
13,5 cm



PARKER  
M18.110.18  
18 cm

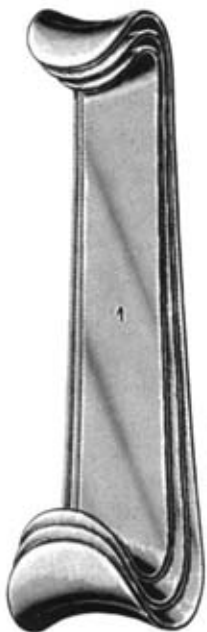

ROUX  
M18.120.00

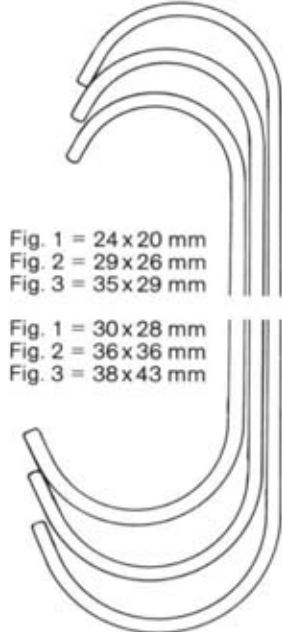
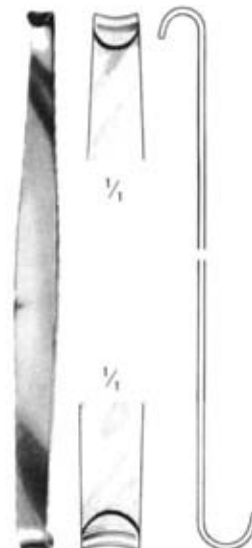

Fig. 1 = 24 x 20 mm  
Fig. 2 = 29 x 26 mm  
Fig. 3 = 35 x 29 mm

Fig. 1 = 30 x 28 mm  
Fig. 2 = 36 x 36 mm  
Fig. 3 = 38 x 43 mm



ROUX Baby  
M18.122.13  
13 cm



ROUX Mini  
M18.124.15  
15 cm



CRILE  
M18.127.11  
11,5 cm

Wundhaken  
Retractors  
Ecarteurs  
Separadores  
Divaricatori



Fig. 2 = 25 x 24 mm  
Fig. 1 = 21 x 24 mm

Fig. 1 = 40 x 15 mm  
Fig. 2 = 45 x 15 mm

US Army (PARKER-LANGENBECK)  
M18.131.21  
21 cm



Fig. 2 = 47 x 13 mm  
Fig. 1 = 42 x 13 mm

Fig. 1 = 42 x 26 mm  
Fig. 2 = 46 x 26 mm

MATHIEU  
M18.134.20  
20 cm



37 x 40 mm

GOLET  
M18.135.19  
19 cm



52 x 33 mm

COLLIN-HARTMANN  
M18.137.16  
16 cm

Wundhaken  
Retractors  
Ecarteurs  
Separadores  
Divaricatori

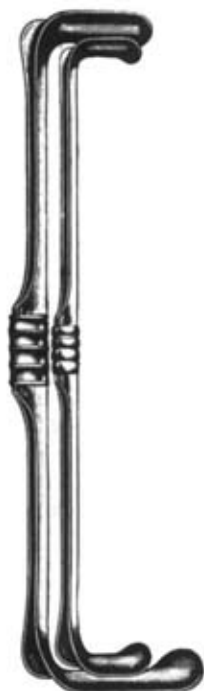

M18.150.01  
28 x 20 mm

M18.150.02  
36 x 28 mm

M18.150.03  
44. X 38 mm



RICHARDSON



RICHARDSON Grip  
M18.152.25 20 x 25 mm  
M18.152.25 25 x 31 mm  
M18.152.25 38 x 38 mm  
M18.152.25 19 x 51 mm  
M18.152.25 41 x 64 mm



65 x 50 mm

KELLY  
M18.156.26  
26 cm

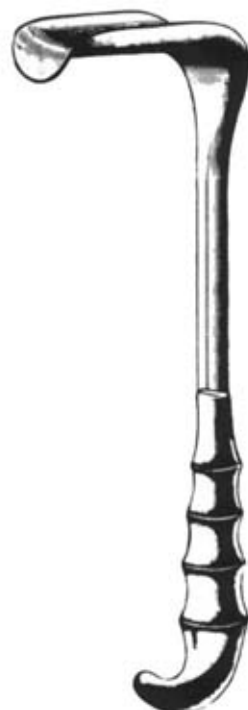

KELLY Grip  
M18.158.51 38 x 51 mm  
M18.152.64 51 x 64 mm  
M18.152.76 64 x 76 mm  
M18.152.82 70 x 82 mm

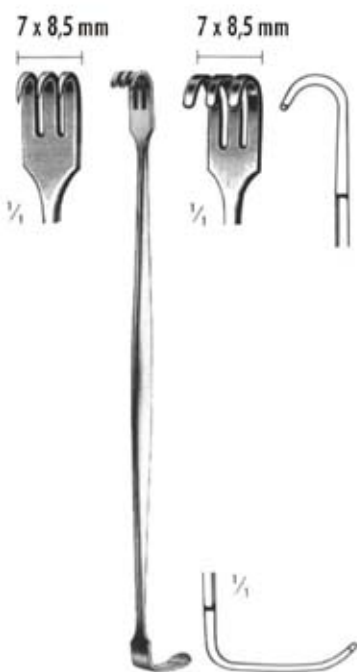

7 x 8,5 mm

7 x 8,5 mm

SENN

M18.160.17 17 cm M18.161.17



RIBBON

M18.168.12 12 x 200 mm  
M18.168.17 17 x 250 mm  
M18.168.25 25 x 250 mm



RIBBON

M18.170.25 25 x 330  
M18.170.32 32 x 330  
M18.170.40 40 x 330  
M18.170.50 50 x 330



HARBERER

M18.174.17 17/15 x 200 mm  
M18.174.25 25/30 x 250 mm  
M18.174.37 37/45 x 300 mm



REVERDIN

M18.175.28  
28 cm



Wundhaken  
Retractors  
Ecarteurs  
Separadores  
Divaricatori



DEAVER Grip  
M18.189.25 25 x 310 mm  
M18.189.38 38 x 310 mm  
M18.189.50 50 x 310 mm



HARRINGTON  
M18.191.25 25 x 230 mm  
M18.191.40 40 x 320 mm  
M18.191.62 62 x 320 mm

Wundhaken  
Retractors  
Ecarteurs  
Separadores  
Divaricatori



Wundhaken  
Retractors  
Ecarteurs  
Separadores  
Divaricatori



DESMARRES  
16 cm



CUSHING  
20 cm

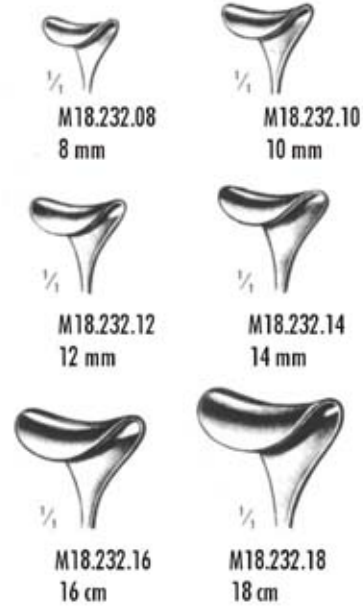

CUSHING  
M18.234.20  
20 cm



SUSHING  
M18.234.21  
21,5 cm



SENN-GRENN  
M18.240.10 10 x 6 mm  
M18.240.20 20 x 6 mm



VOLKMANN  
11.5 cm



Wundhaken  
Retractors  
Ecarteurs  
Separadores  
Divaricatori



M18.280.01



M18.280.02



M18.280.03



M18.280.04



M18.280.06



1/2



M18.281.01



M18.281.02



M18.281.03



M18.281.04



M18.281.06



1/2



VOLKMANN  
21.5 cm



18 x 7 mm M18.302.01



16 x 5 mm M18.302.02



7 x 4 mm M18.302.03



7 x 4 mm M18.302.04



10 x 3 mm M18.302.05



10 x 4 mm M18.302.06



MEYERDING  
18 cm



28 x 6 mm



LAHEY  
M18.304.19  
19 cm

12 x 14 mm



LITTLE  
M18.306.20  
20 cm

Wundhaken  
Retractors  
Ecarteurs  
Separadores  
Divaricatori

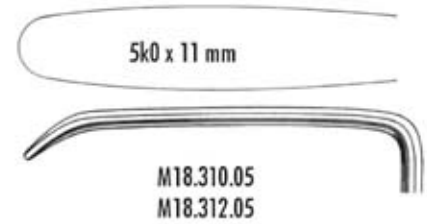
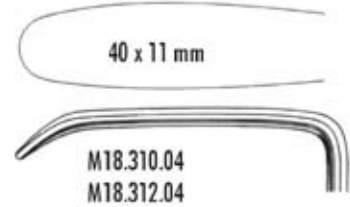
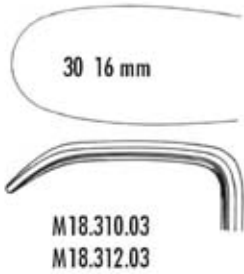
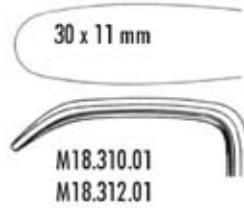

**LANGENBECK**

M18.310.01      M18.312.01  
- M18.310.05    - M18.312.05  
22 cm            21 cm



M18.341.20 60 x 20 mm



M18.314.07 35 x 7 mm



M18.314.10 35 x 10 mm



M18.314.15 25 x 15 mm

LANGENBECK  
M18.314.07  
21 cm

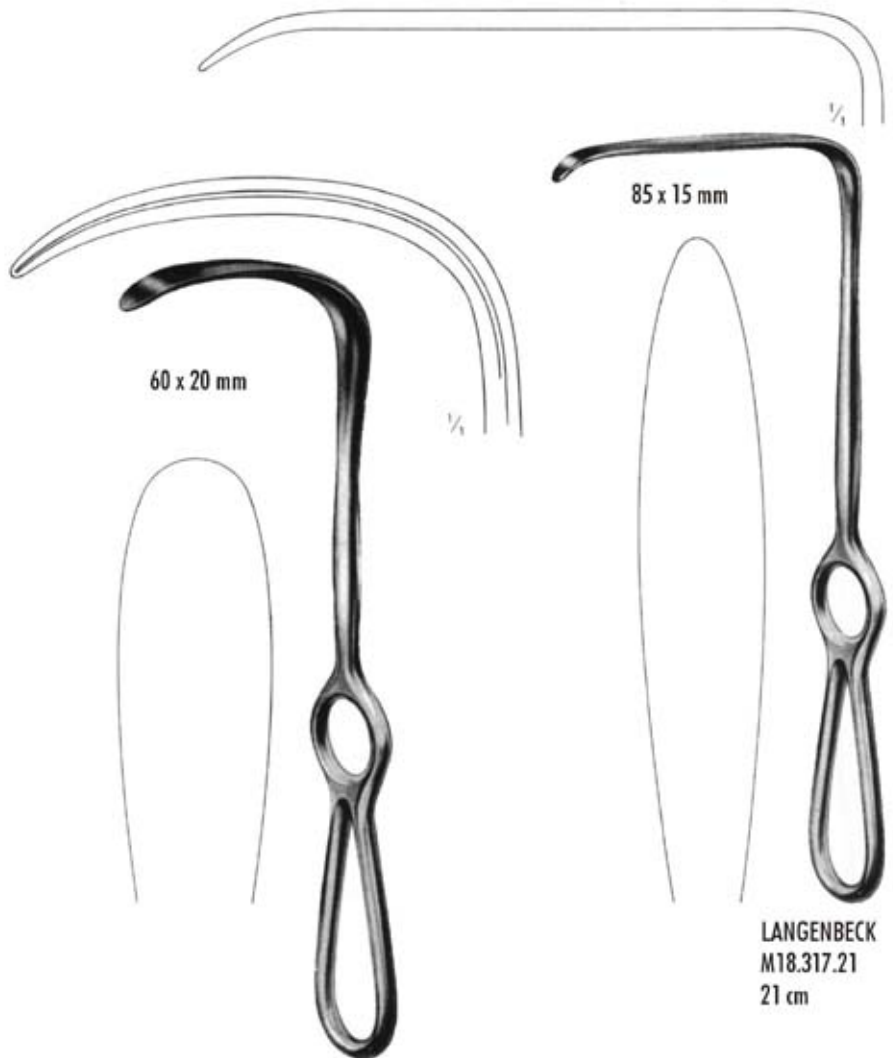

60 x 20 mm

85 x 15 mm

LANGENBECK  
M18.315.21  
21 cm

LANGENBECK  
M18.317.21  
21 cm

Wundhaken  
Retractors  
Ecarteurs  
Separadores  
Divaricatori



M18.318.78  
78 x 40 mm



M18.318.57  
57 x 25 mm



M18.318.40  
40 x 18 mm



M18.318.40-M18.318.78  
23 cm



M18.344.14  
14 x 17 mm  
21,5 cm



M18.344.20  
20 x 22 mm  
22 cm



M18.344.26  
26 x 30 mm  
23,5 cm



MIDDELDORPF  
M18.344.14-M18.344.26



M18.330.40

M18.330.55  
55 x 11 mm

KOCHER  
M18.330.40-M18.330.55  
19 cm



GREEN  
M18.348.22  
22 cm

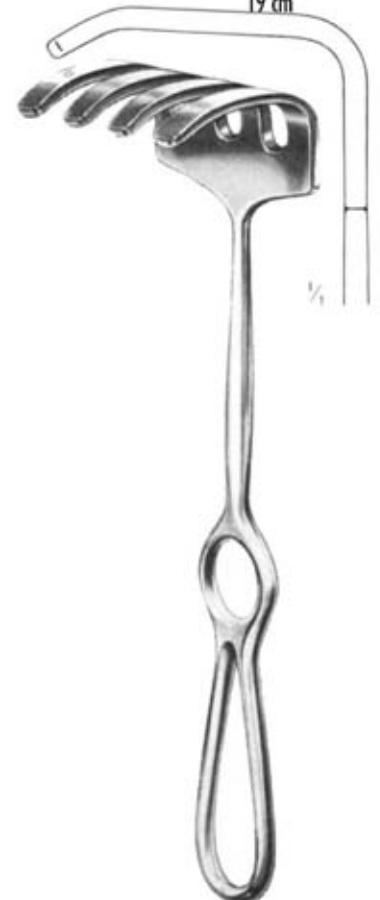

OLLIER  
M18.360.04  
22,5 cm

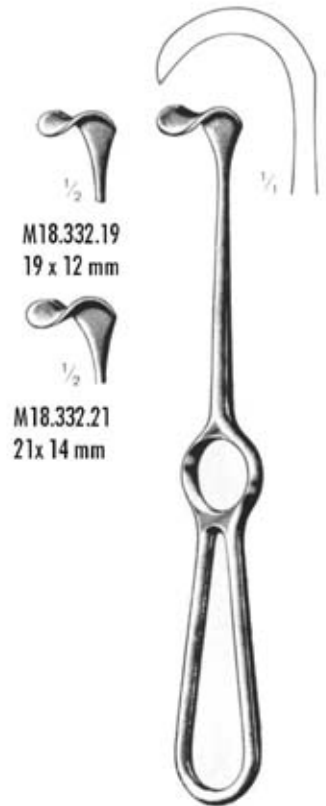

M18.332.19  
19 x 12 mm

M18.332.21  
21 x 14 mm

KOCHER  
M18.332.19-M18.332.21  
19 cm

KOCHER mm  
M18.340.10 40 x 10  
M18.340.15 40 x 15  
M18.340.20 40 x 20  
22 cm

Wundhaken  
Retractors  
Ecarteurs  
Separadores  
Divaricatori

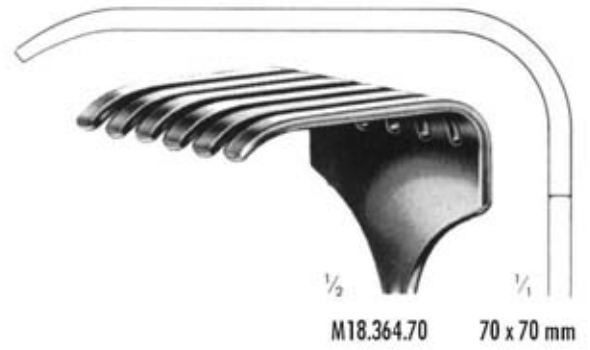
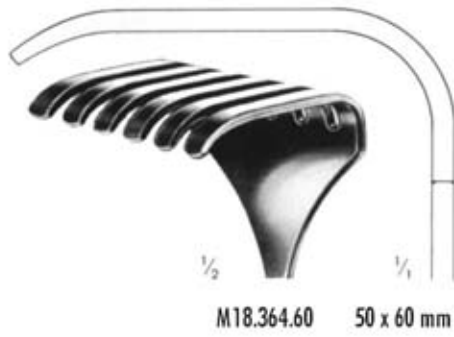
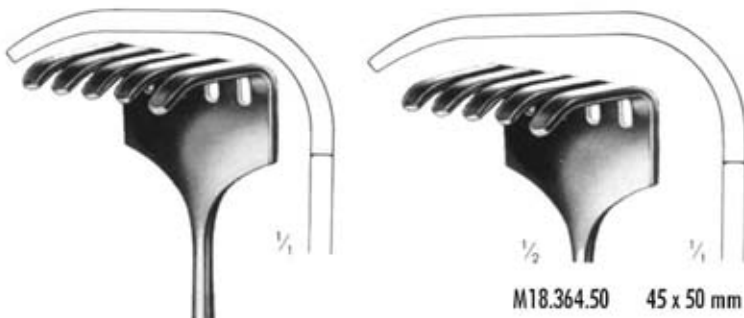

ISRAEL  
M18.364.40  
40 x 40 mm  
25 cm



M18.36.08 23,5 cm M18.367.08

FRITSCH mm  
M18.370.40 45 x 40  
M18.370.50 45 x 50  
M18.370.60 45 x 60  
M18.370.75 45 x 75

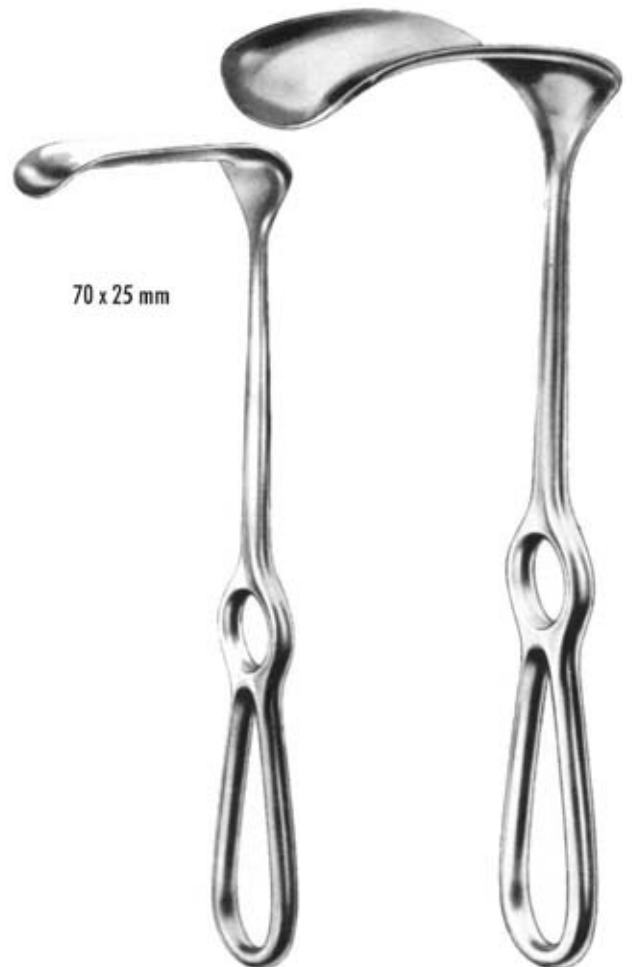

KOCHER  
M18.372.22  
22,5 cm

KOCHER mm  
M18.374.45 80 x 45  
M18.374.55 80 x 55  
M18.374.65 80 x 65  
25 cm

Wundhaken  
Retractors  
Ecarteurs  
Separadores  
Divaricatori



DOXEN  
M18.378.25  
25 cm

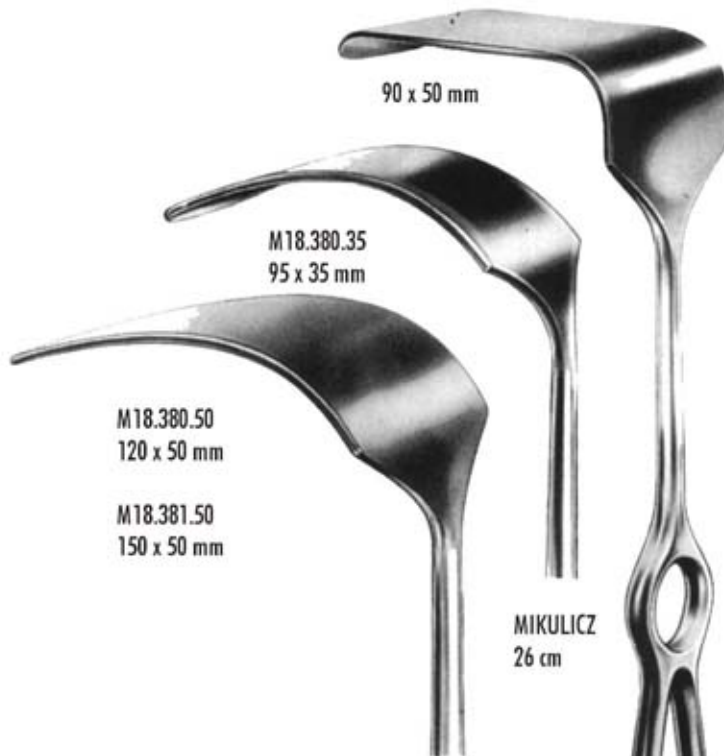

90 x 50 mm

M18.380.35  
95 x 35 mm

M18.380.50  
120 x 50 mm

M18.381.50  
150 x 50 mm

MIKULICZ  
26 cm

MIKULICZ  
26 cm



M18.482.82  
82 x 28 mm

M18.482.73  
73 x 28 mm

M18.482.45  
45 x 25 mm

MIKULICZ  
M18.382.50  
26 cm

1/2

1/2

mm	KELLY
160 x 38	M18.385.38
160 x 57	M18.385.57
	27 cm

SIMON	mm
M18.480.22	115 x 22
M18.480.27	115 x 27
	28 cm

HEANEY
M18.482.45-M18.482.82
27 cm



Wundhaken  
Retractors  
Ecarteurs  
Separadores  
Divaricatori

M18.490.65  
115 x 65 mm



M18.490.43  
108 x 43 mm

M18.490.22  
82 x 22 mm



125 x 37 mm

CORYLLOS (Thorax)  
M18.490.22-M18.490.65  
24 cm

SAUERBRUCH  
M18.492.25  
25 cm

M18.494.45  
45 x 15 mm

M18.494.60  
60 x 23 mm

M18.494.75  
75 x 20 mm



SAUERBRUCH  
M18.494.45-M18.494.75  
22,5 cm



DAVIDSON (Scapula)  
M18.496.50  
75 x 50 mm



DAVIDSON (Scapula)  
M18.496.90  
75 x 90 mm

Wundsperrer  
Retractors  
Ecarteurs  
Separadores  
Divaricatori

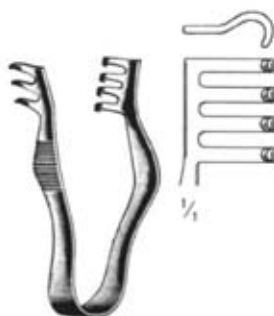

FINSEN

M18.610.07 7 cm M18.611.07



ALM

M18.620.07 7 cm M18.621.07  
M18.620.10 10 cm M18.621.10



JANSEN  
M18.630.10  
10 cm



JANSEN  
M18.631.10  
10 cm



M18.634.10 10 cm M18.635.10

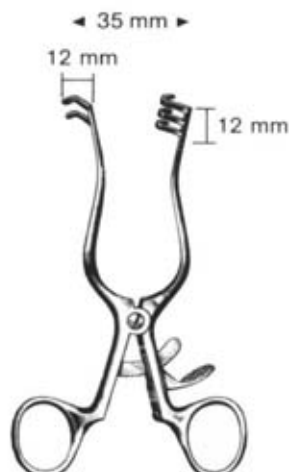

WEITLANER

M18.650.10 11,5 cm M18.651.10

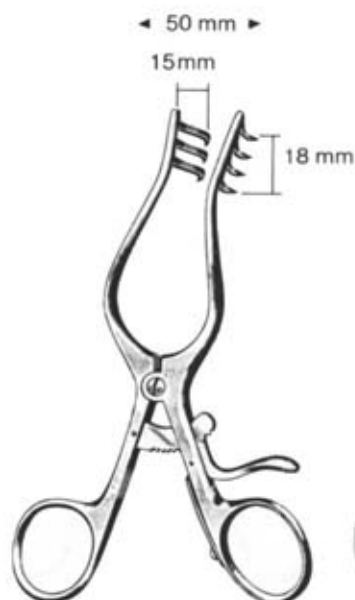

WEITLANER-WULLSTEIN  
M18.654.13 13 cm M18.655.13



PLESTER  
M18.657.11  
11 cm



PLESTER  
M18.659.11  
11 cm



WEITLANER

M18.670.14 14,0 cm M18.671.14  
M18.670.14 14,5 cm M18.671.16  
M18.670.20 20,0 cm M18.671.20

Wundsperrer  
Retractors  
Ecarteurs  
Separadores  
Divaricatori

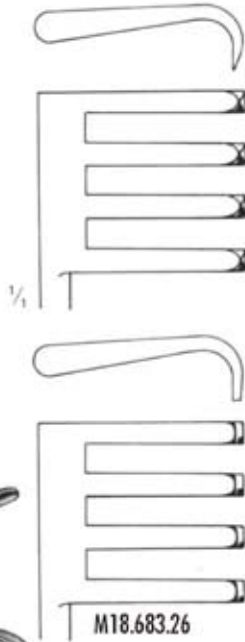
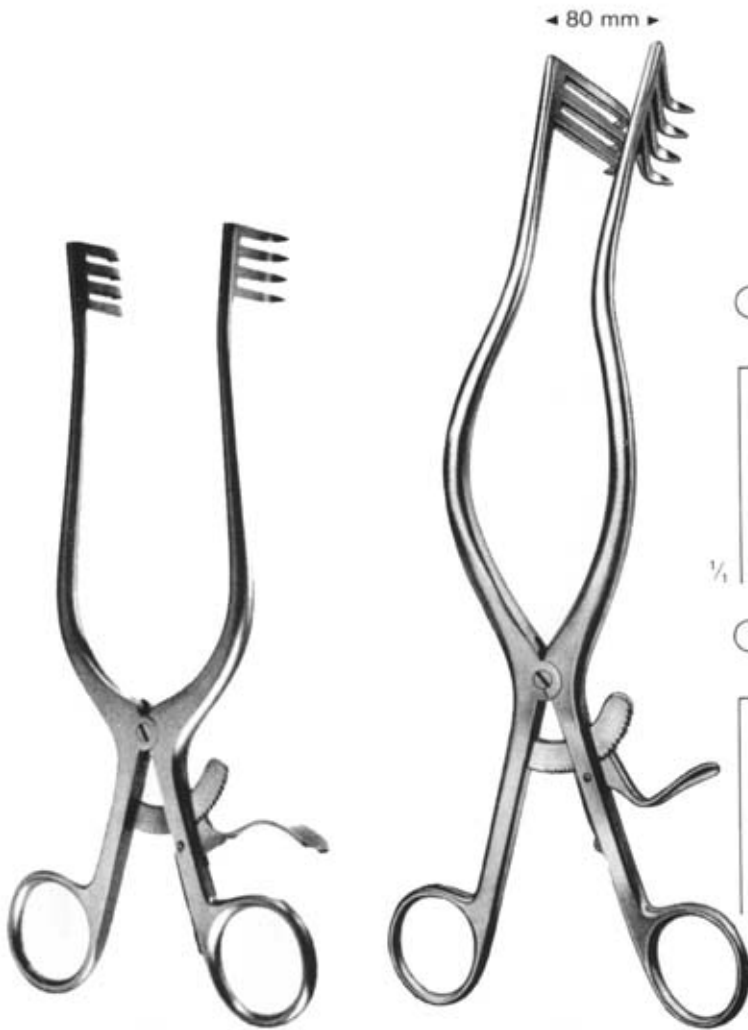

M18.683.26

M18.680.19 ADSON 19 cm M18.681.19

M18.682.26-M18.683.26 ADSON 26,5 cm



ADSON M18.686.32 32 cm

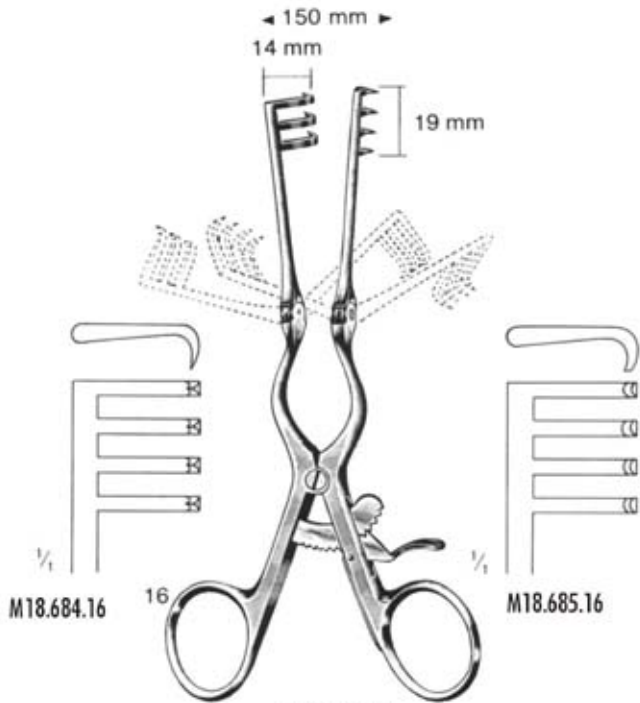

M18.684.16

16

M18.685.16

ADSON Baby M18.684.16-M18.685.16 16 cm

Wundsperrer  
Retractors  
Ecarteurs  
Separadores  
Divaricatori

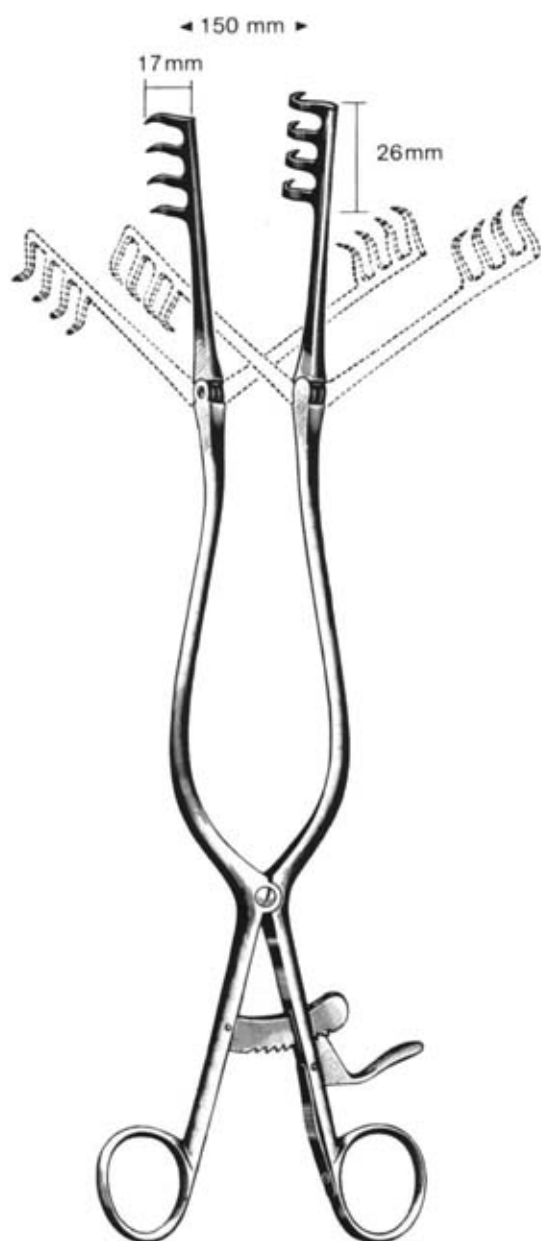

BECKMANN  
M18.690.31  
31 cm



BECKMANN-EATON  
M18.692.32  
32 cm

Wundsperrer  
Retractors  
Ecarteurs  
Separadores  
Divaricatori

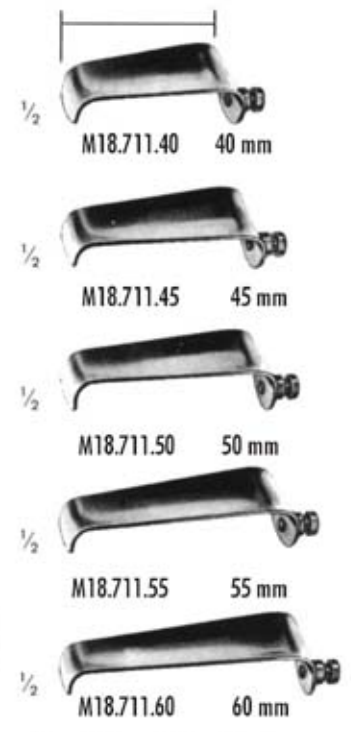
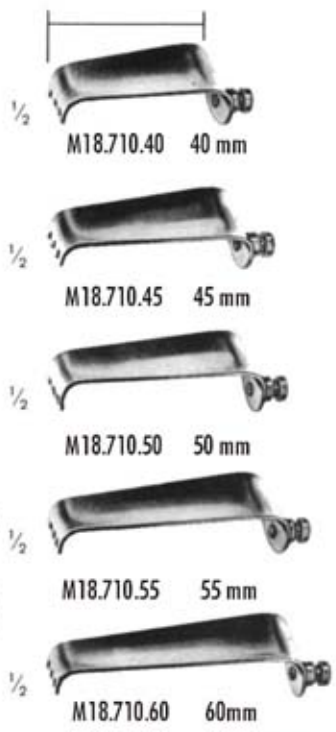

Ohne Valven . Without blades  
sans valves . Sin valvas . Senza valve

Ohne Valven . Without blades  
sans valves . Sin valvas . Senza valve

Wundspreizer, cerv. Wirbelsäule  
 Retractors, Cervical Spine  
 Ecarteurs, colonne cervicale  
 Separadores, columna espinal  
 Divaricatori, spina cervica



CASPAR  
 M18.720.00 compl.  
 M18.720.15 ohne Vaven . Without blades  
 sans valves . Sin valvas . Senza valva



CASPAR  
 M18.721.00 comp.  
 M18.721.15 ohne valven . Without blades . Sans valves . Sin valvas . Senza valva



CASPAR  
 M18.724.00 compl  
 M18.724.00



Stumpf  
 blunt  
 mousse  
 roma  
 smussa

mm	CASPAR
45 x 20	M18.720.45
50 x 20	M18.720.50
55 x 20	M18.720.55
60 x 20	M18.720.60
65 x 20	M18.720.65



Medial

mm	CASPAR
45 x 20	M18.724.40
50 x 20	M18.724.45
55 x 20	M18.724.50
60 x 20	M18.724.55
65 x 20	M18.724.60



Lateral

mm	CASPAR
45 x 20	M18.725.40
50 x 20	M18.725.45
55 x 20	M18.725.50
60 x 20	M18.725.55
65 x 20	M18.725.60

Wundsperrer, ges. Wirbelsäule  
 Retractors, vertebral Column  
 Ecarteurs, colonne vertébrale  
 Separadores, columna vertebral  
 Divaricatori, colonna vertebrale



CASPAR  
 M18.730.00 compl  
 M18.730.15 ohne Valven . Without lades . Sans valves . Sin valvas . Senza valve



Mm CASPAR  
 50 M18.731.50



Mm CASPAR  
 70 m18.731.70



mm	CASPAR
35 x 22	M18.732.35
40 x 22	M18.732.40
45 x 22	M18.732.45
50 x 22	M18.732.50
55 x 22	M18.732.55
60 x 22	M18.732.60
65 x 22	M18.732.65
70 x 22	M18.73270

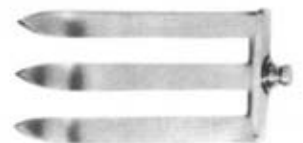

mm	CASPAR
35 x 37	M18.733.35
40 x 37	M18.733.40
45 x 37	M18.733.45
50 x 37	M18.733.50
55 x 37	M18.733.55
60 x 37	M18.733.60
65 x 37	M18.733.65
70 x 37	M18.73270



CASPAR  
 M18.740.00 compl.  
 M18.740.15 ohne Valven . Without blades . Sans valves . Sin valvas . Senza valve

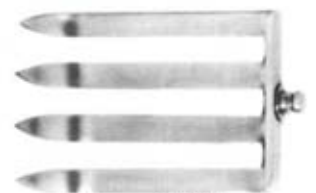

mm	CASPAR
35 x 52	M18.734.35
40 x 52	M18.734.40
45 x 52	M18.734.45
50 x 52	M18.734.50
55 x 52	M18.734.55
60 x 52	M18.734.60
65 x 52	M18.734.65
70 x 52	M18.73470

Wundspreizer  
Retractors  
Ecarteurs  
Separadores  
Divaricatori

M18.745.40  
40 mm



M18.745.45  
45 mm



M18.745.55  
50 mm



M18.745.55  
60 mm



M18.745.60  
60 mm



M18.745.70  
70 mm



CASPAR

M18.744.00 compl incl. 7 Valven . Blades

valves . Valvas . Vvalve

M18.744.17 ohne Valven . Without blades . Sans valves . Sin valvas .senza valve



M18.747.45  
45 mm

M18.747.50  
50 mm

M18.747.55  
55 mm

M18.747.60  
60 mm

M18.747.65  
65 mm



CASPAR

M18.747.45-M18.747.65



Bauchdeckenhalter  
Abdominal Retractors  
Ecarteurs abdominaux  
Separadores abdominales  
Divaricatori addominali

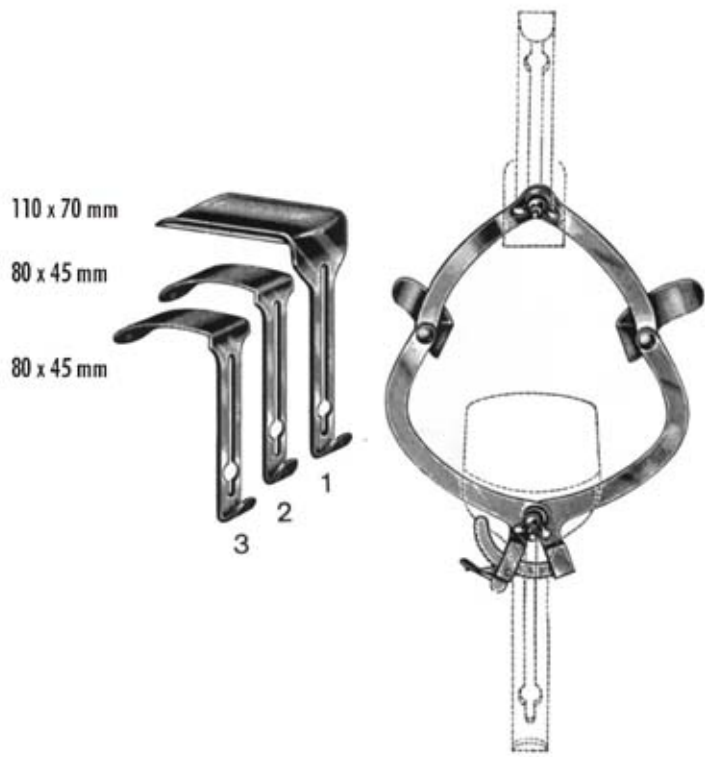

O'SULLIVAN-O'CONNOR  
M18.754.00

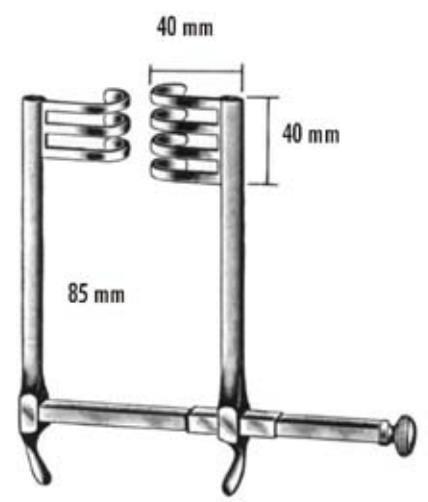

FRAZIER  
M18.758.85

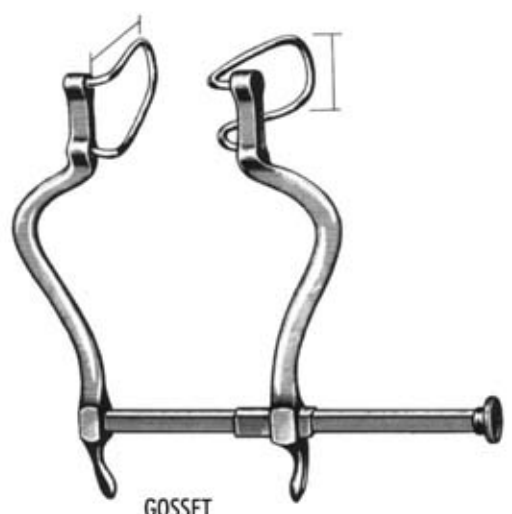

GOSSET  
M18.760.14

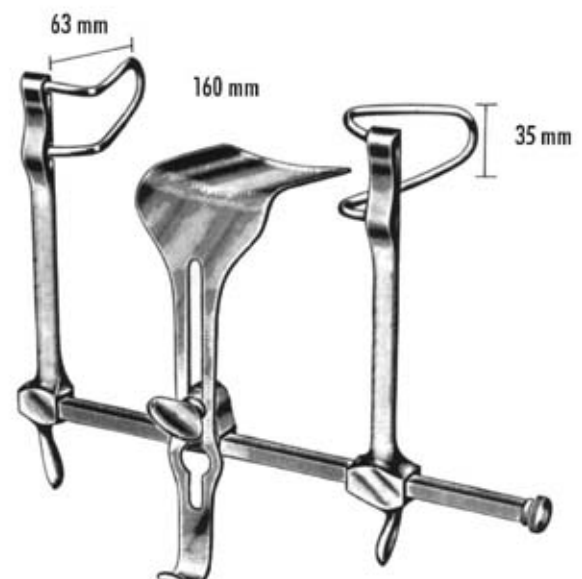

GOSSET  
M18.762.16

Bauchdeckenhalter  
 Abdominal Retractors  
 Ecarteurs abdominaux  
 Separadores abdominales  
 Divaricatori addominali

< 180 mm >

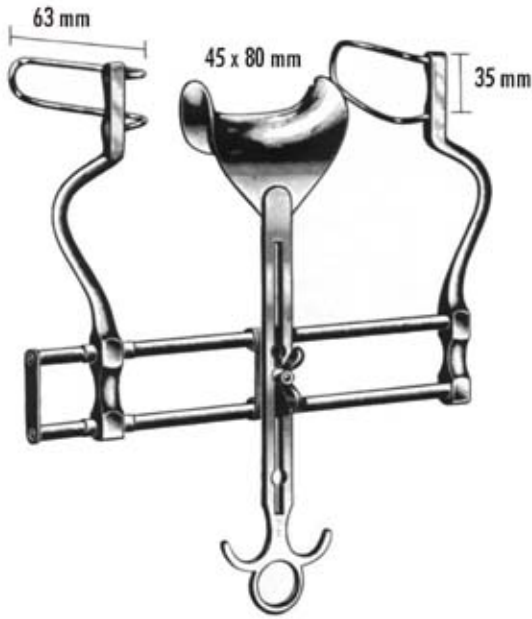

BALFOUR  
 M18.764.18  
 18 cm

< 200 mm >

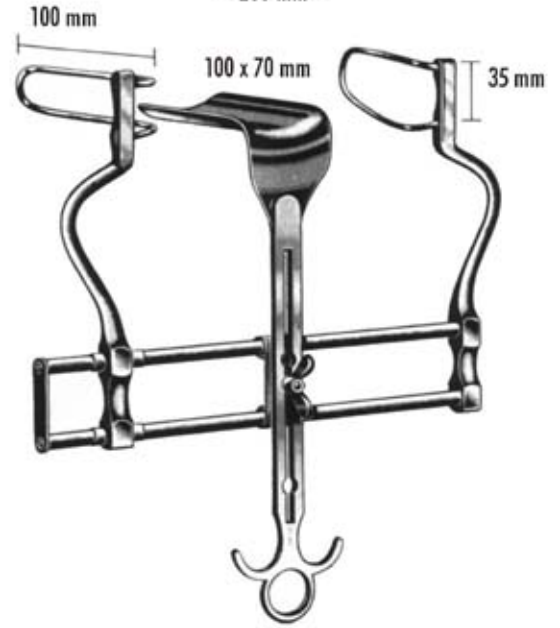

BALFOUR  
 M18.754.20  
 20 cm



BALFOUR  
 M18.764.25  
 25 cm

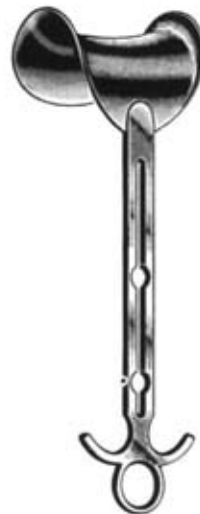

mm	BALFOUR
45 x 80	M18.765.45
70 x 85	M18.765.70
80 x 90	M18.765.80

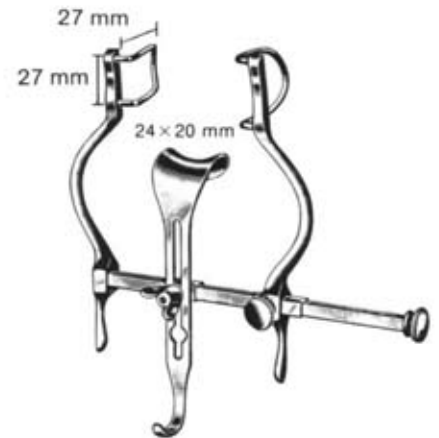

BALFOUR Baby  
 M18.766.90  
 9 cm

Bauchdeckenhalter  
Abdominal Retractors  
Ecarteurs abdominaux  
Separadores abdominales  
Divaricatori addominali

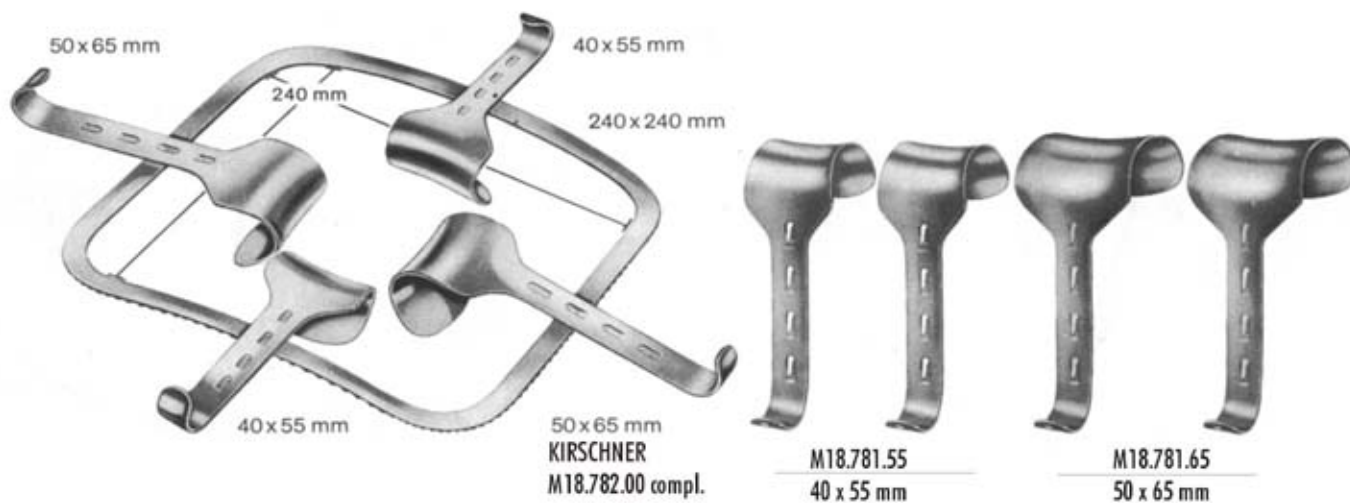
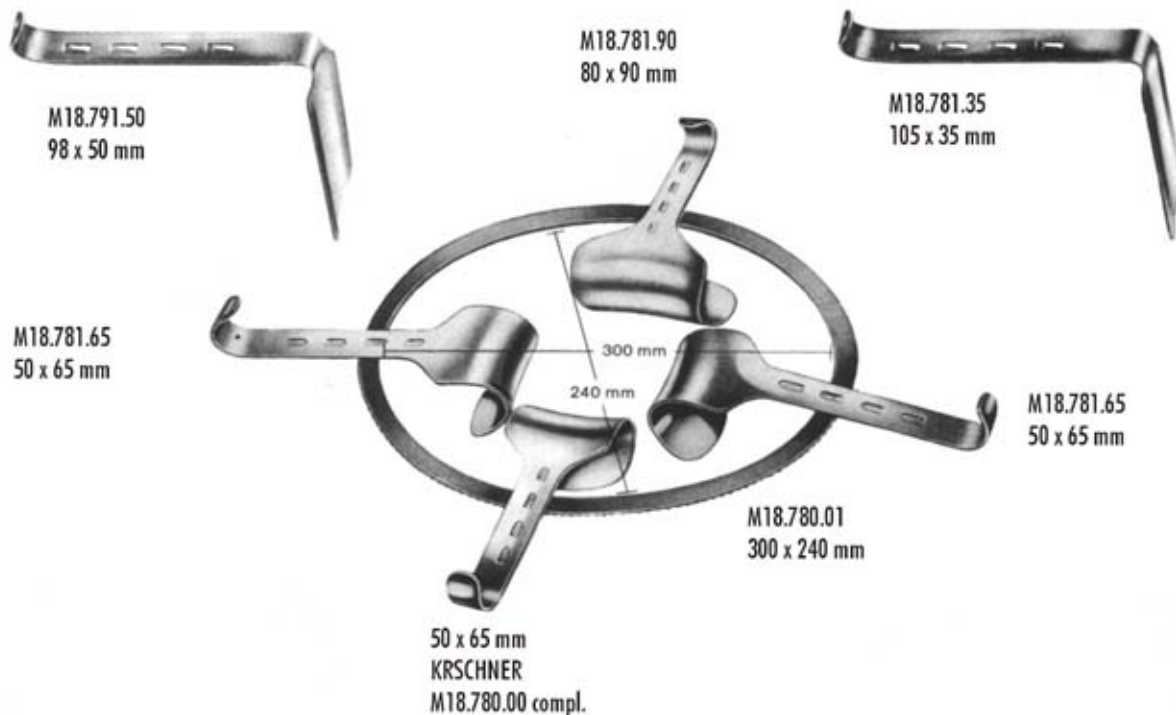

Bauchdeckenhalter  
Abdominal Retractors  
Ecarteurs abdominaux  
Separadores abdominales  
Divaricatori addominali



cm	GELPI
9	M18.802.09
14	M18.802.14
16	M18.802.16
18	M18.802.18



GELPI  
M18.804.18  
18 cm



RIGBY  
M18.806.18  
18 cm



COLLIN  
M18.810.22



Centraal/mm	COLLIN
38 x 55	M18.812.60
50 x 75	M18.812.80

Bauchdeckenhalter  
Abdominal Retractors  
Ecarteurs abdominaux  
Separadores abdominales  
Divaricatori addominali

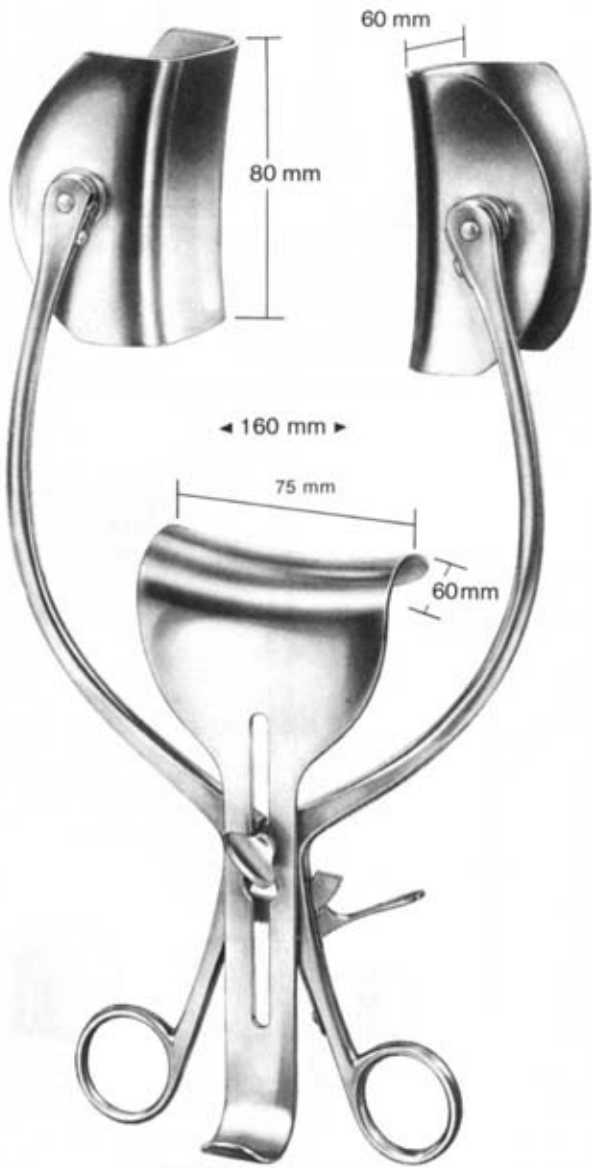

COLLIN Lokite  
M18.816.00

Muskelhaken  
Muscle Retractors (Hooks)  
Ecarteurs musculaires  
Separadores (ganchos) musculares  
Divaricatori (nnicini) muscolari



M18.90k2.10  
10 cm



M18.903.00

Sonden  
Probes, Directors  
Stylets, sondes  
Sondas, estiletos  
Sonde, specilli



cm	2 mm Ø	1 mm Ø	2 mm Ø	DOYEN		STACKE Ø
10,5						M20.115.10
11,5	M20.102.11	M20.104.11	M20.106.11			
13,0	M20.102.13	M20.103.13	M20.106.13		M18.110.13	
14,0					M20.114.14	
14,5	M20.102.14	M20.104.14	M20.106.14	M20.108.14	M20.110.14	M20.112.14
16,0	M20.102.16	M20.104.16	M20.106.16		M20.110.16	
18,0	M20.102.18	M20.104.18	M20.106.18		M20.110.18	
20,0	M20.102.20	M20.104.20	M20.106.20		M20.110.20	
22,0	M20.102.22	M20.104.22	M20.106.22			
25,0	M20.102.25	M20.104.25	M20.106.25			

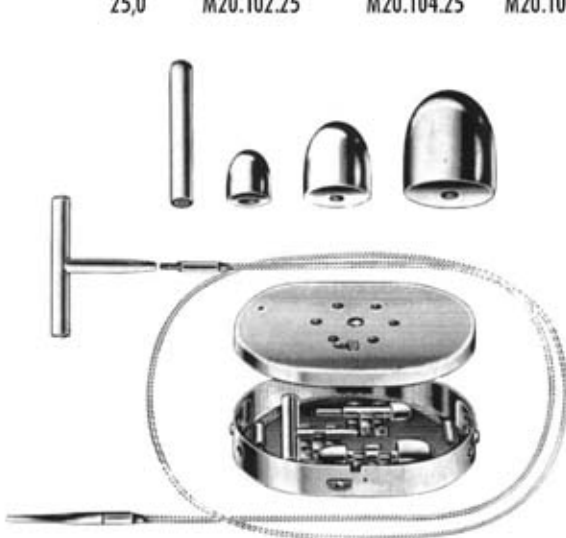

**NABATOFF**  
M20.540.00  
135 x 100 x 25 mm  
compl.

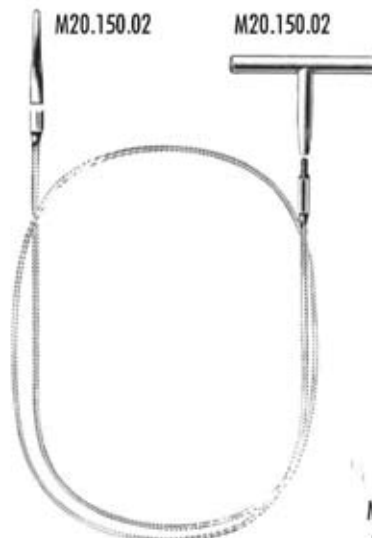

M20.150.02



M20.150.03  
3 mm Ø

M20.150.06  
6 mm Ø



M20.150.09  
9 mm Ø

M20.150.12  
12 mm Ø

M20.150.15  
15 mm Ø

Varizenbesteck  
Varikose vin probe set  
Trousse à varices  
Desobliterador  
Astuccio per varice

Spatel, Watteträger  
 Spatulas, Cotton Applicators  
 Spatules, porte-coton  
 Espátulas, porta-algodón  
 Spatole, portacotone

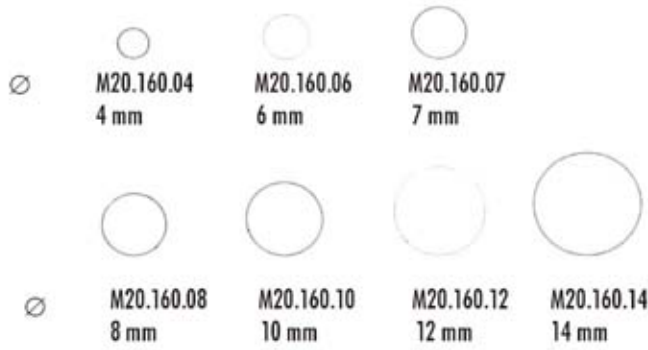

M20.150.04-M20.160.14



M20.162.12  
 12 cm



13,0 cm M20.190.13  
 14,5 cm M20.190.14

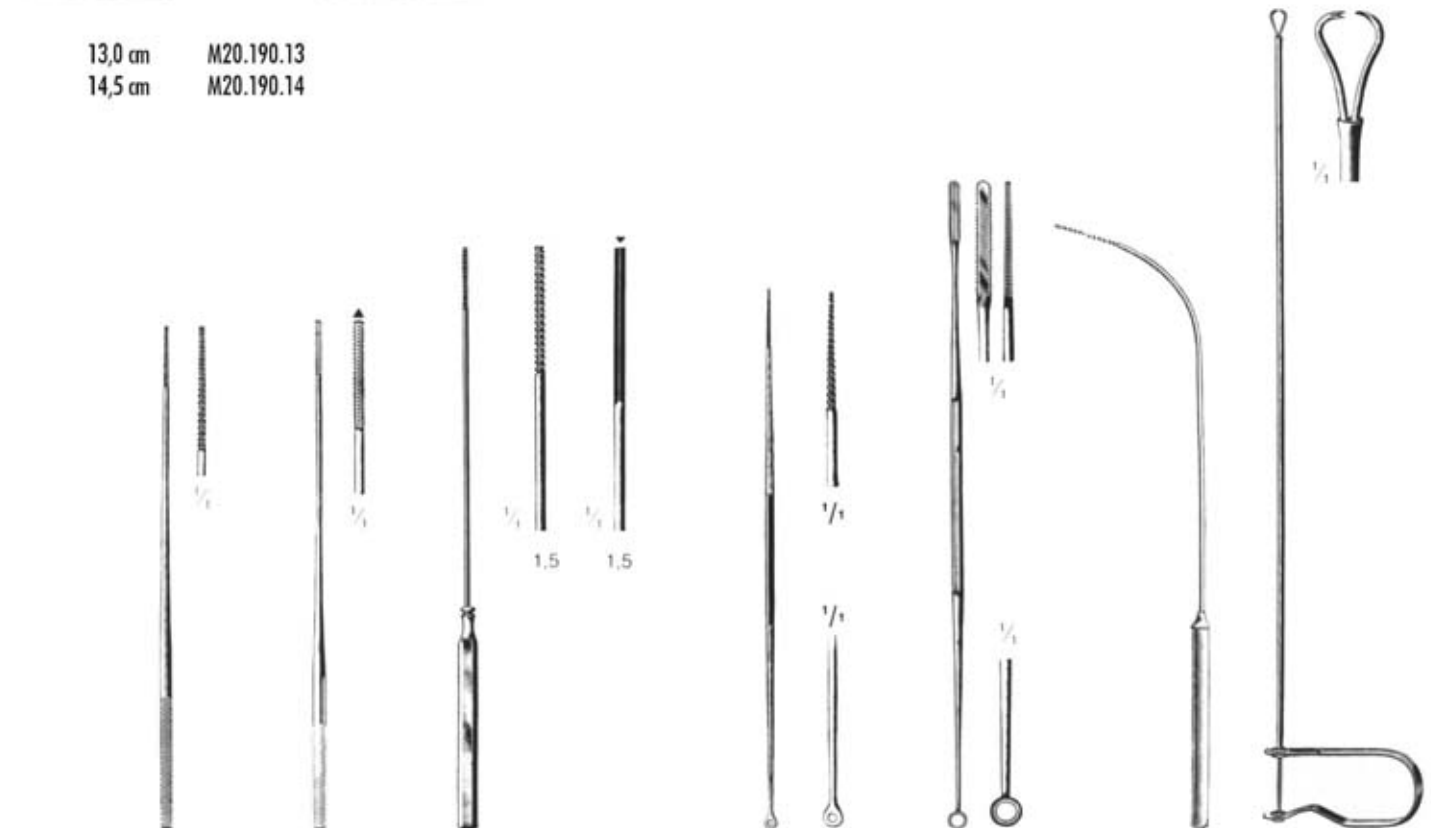

cm	FARRELL	FARRELL		UCKERMANN	JOBSON-HORNE	TOBOLD
12,0	M20.270.12	M20.272.12	M200.290.12	M20.292.12		
14,0	M20.270.14	M20.272.14	M200.290.14	M20.292.14	M20.320.12	
15,0				M20.310.15		
16,0			M20.290.16	M20.290.16		
16,5	M20.270.16	M20.272.16				
18,0	M20.270.18	M20.272.18	M20.290.18	M20.292.18	M20.320.18	
23,0	M20.270.18	M20.272.18				
25,0						M20.320.25
45,0						M20.340.45

Trokare  
Trocars  
Trocart  
Trócares  
Trequarti



Universal  
M22.104.00  
compl.



DOUGLAS  
M22.125.11  
3 mm

FLEURANT  
M22.127.23  
23 cm  
5 mm Ø



LICHTWITZ  
M22.128.19  
1,75 mm Ø



COAKLEY  
M22.140.02  
2,25 mm Ø



Charr./ FG.	OCHSNER
10	M22.150.10
12	M22.150.12
14	M22.150.14
16	M22.150.16
18	M22.150.18
20	M22.150.20

Charr./ FG.	NELSON
25.	M22.170.25
30.	M22.170.30
33.	M22.170.33
35.	M22.170.35



Biopsie, Leber, Niere  
 Biopsy, Liver, Kidney  
 Biopsie, foie, reins  
 Biopsia, hígado, riñón  
 Biopsia, fegato, rene

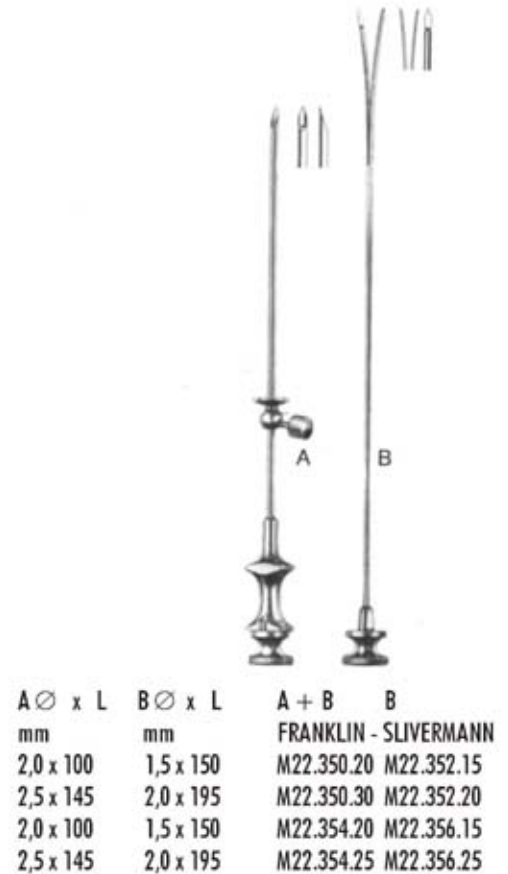
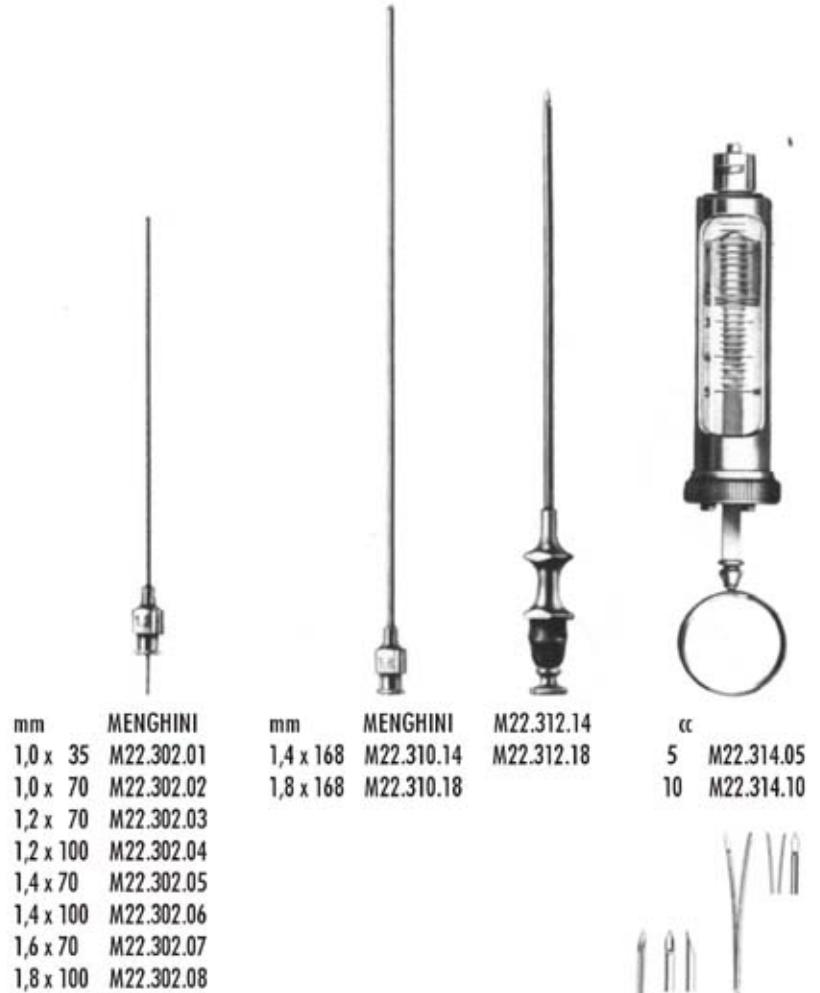

Nadelhalter  
Needle Holders  
Porte-aiguilles  
Porta-agujas  
Port'aghi

Mit TC-Einsätzen  
TC Lined  
A mors TC  
Con bocas TC  
Con morso TC



COLLIER  
M24.122.12  
12,5 cm

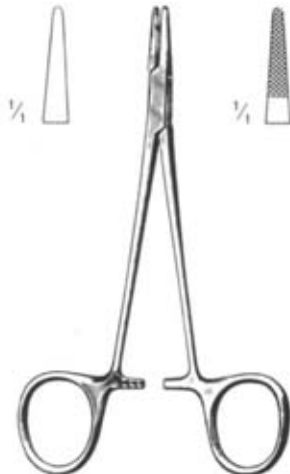

HALSEY  
M24.130.13 M24.140.13  
M24.134.13 M14.144.13



DERF  
M24.110.12 12 cm M24.113.12



DERF  
M24.120.12  
12,5 cm



NEIVERT  
M14.146.13



BAUMGARTNER  
M24.150.12 12,5 cm M24.154.12  
M24.150.14 14,0 cm M24.154.14



CCRILE-WOOD  
M24.160.15 15 cm M24.164.15  
M24.160.18 18 cm M24.164.18  
M24.160.20 20 cm M24.164.20



CRILE-MURRAY  
M24.170.15 15 cm M24.174.15

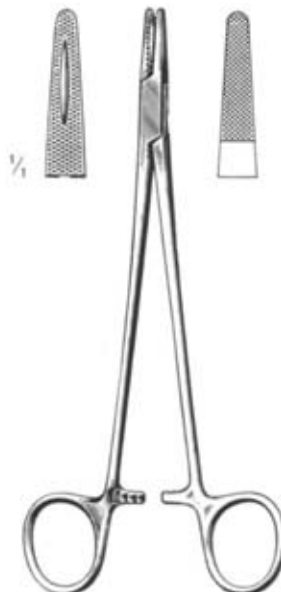

MAYO-HEGAR  
M24.180.14 14 M24.184.14  
M24.180.16 16 M24.184.16  
M24.180.18 18 M24.184.18  
M24.180.20 20 M24.184.20  
M24.180.24 24 M24.184.24  
M24.180.26 26 M24.184.26  
M24.180.30 30 M24.184.30



MAYO-HEGAR  
M24.190.16 16 cm M24.194.16  
M24.190.18 18 cm M24.194.18  
M24.190.20 20 cm M24.194.20

Nadelhalter  
Needle Holders  
Porte-aiguilles  
Porta-agujas  
Port'aghi

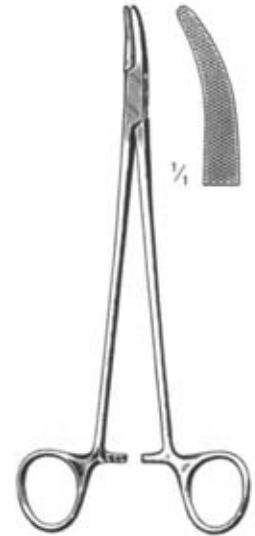

cm	DE BAKEY	RYDER
13		M24.224.13
15	M24.214.18	M24.224.15
18	M24.214.18	M24.224.18
20	M24.214.20	M24.224.20
23	M24.214.23	M24.224.23
26	M24.214.26	M24.224.26
31	M24.214.31	
37	M24.214.37	

JAMISON  
M24.230.23 23,5 cm M24.234.23

HEANEY  
M24.241.21 21 cm M24.245.21



MASSON  
M24.250.27 27 cm M24.254.27

WANGENSTEEN  
M24.260.27 27 cm M24.264.27

WANGENSTEEN  
M24.270.27 27 cm M24.274.27

cm BOZEMANN  
20 M24.285.20  
24 M24.285.24  
26 M24.285.26

Nadelhalter  
Needle Holders  
Porte-aiguilles  
Porta-agujas  
Port'aghi

MIT TC-Einsätzen  
TC Lined  
A a mors TC  
Con bocas TC  
Con morso TC



**METZENBAUM**  
M24.290.18  
18 cm



**ADSON**  
M24.292.18  
18 cm

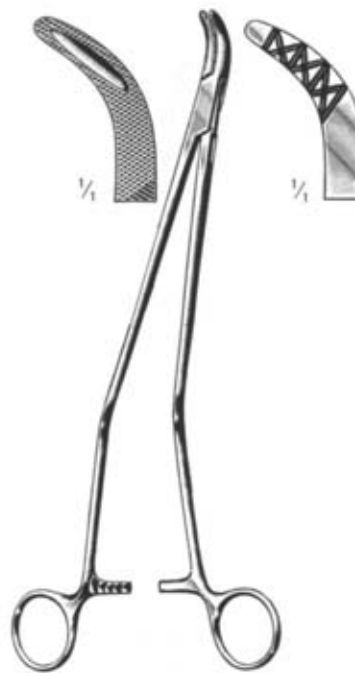

**JOHNSON**  
M24.293.27  
27 cm



**FINOCHIETTO**  
M24.311.20 20 cm M24.315.20  
M24.311.27 27 cm M24.315.27



**SAROT**  
M24.320.18 18 cm M24.324.18  
M24.320.26 26 cm M24.324.26



**STRATTE**  
M24.330.23 23 cm M24.334.23



**CRILE**  
M24.350.15  
15 cm



**TOENNIS**  
M24.360.15 18 cm M24.364.18

Nadelhalter  
Needle Holders  
Porte-aiguilles  
Porta-agujas  
Port'aghi



HOESEL  
M24.367.25  
25 cm



cm MATHIEU  
14 M24.370.14 M24.374.14  
17 M24.370.17 M24.374.17  
20 M24.370.20 M24.374.20  
24 M24.370.24 M24.374.24



MATHIEU  
M24.380.17 M24.384.17  
M24.380.17 M24.384.17



MATHIEU  
M24.390.14 M24.394.14  
M24.390.17 M24.394.17



OLSEN-HEGAR  
M24.410.14 14 cm M24.414.14  
M24.410.18 18 cm M24.414.18



OLSEL-HEGAR  
M24.420.17 17 cm M24.424.17



GILLIES  
M24.430.17 16 cm



M24.434.16

Nadelhalter  
Needle Holders  
Porte-aiguilles  
Porta-agujas  
Port'aghi

Gefäß-Chirurgie  
Vascular surgery  
Chirurgie vasculaire  
Cirugia vascular  
Chirurgia vascolare



Mit TC-Einsätzen  
TC Lined  
A mors TC  
Con bocas TC  
Con morso TC

mm	DIETRICH
16	M24.444.16
18	M24.444.18
20	M24.444.20
23	M24.444.23
26	M24.444.26

Ophthalmologie  
Ophthalmology  
Oftalmologie  
Oftalmologia  
Oftalmologia



STEVENS  
M24.610.11  
11 cm



cm STEVENS  
13 M24.612.13  
15 cm M24.612.15



BOYNTON  
M24.614.12  
12 cm



ARRUGA  
M24.620.16 16 cm M24.624.16

Nadelhalter  
Needle Holders  
Porte-aiguilles  
Porta-agujas  
Port' aghi



**KALT-ARRUGA**  
M24.677.14  
14 cm



**KALT**  
M24.628.14  
14 cm



**BARRAQUER**  
M24.650.10  
10 cm



**BARRAQUER**  
M24.651.10  
10 cm



**BARRAQUER**  
M24.661.13 13 cm **M24.665.13**



**CASTROVIEJO**  
M24.670.14 14 cm  
**M24.674.14** 14 cm



**M24.671.14**  
**M24.675.14**



**CASTROVIEJO**  
M24.680.13 13 cm **M24.664.13**

Unterbindungsnadeln  
 Ligature Needles  
 Aiguilles à ligatures  
 Agujas para ligaduras  
 Aghi per legature

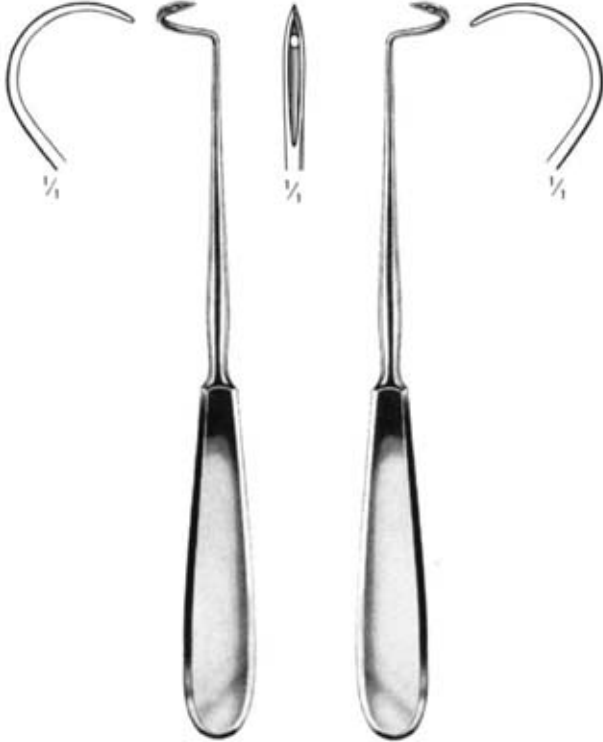

L	DESCHAMPS	R
M26.110.21	21 cm	M21.111.21
M26.110.24	24 cm	M21.111.24
M26.110.27	27 cm	M21.111.27

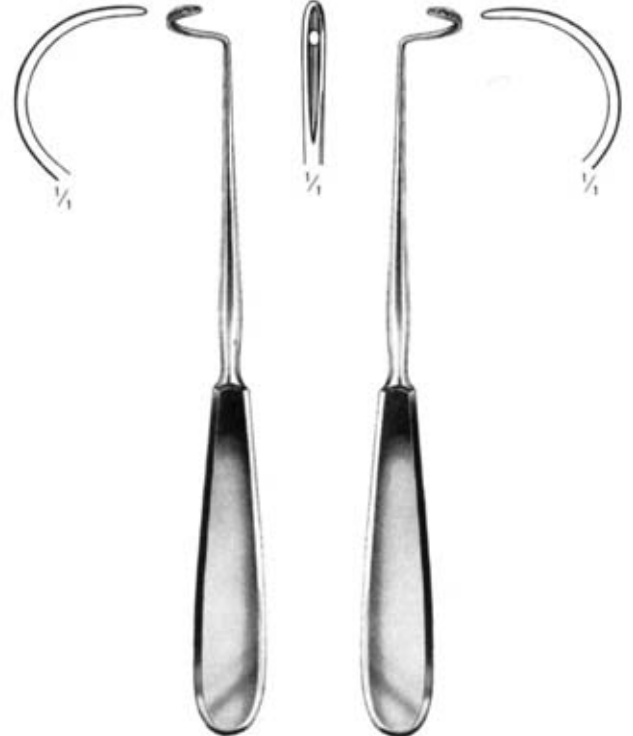

L	DESCHAMPS	R
M26.120.21	21 cm	M26.121.21
M26.120.24	24 cm	M26.121.24
M26.120.27	27 cm	M26.121.27

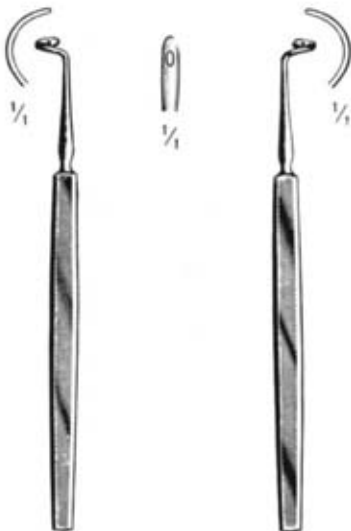

L	KRONECKER	R
M26.130.13	13 cm	M26.131.13



L	NELSON	R
M26.133.24	24 cm	M26.135.24

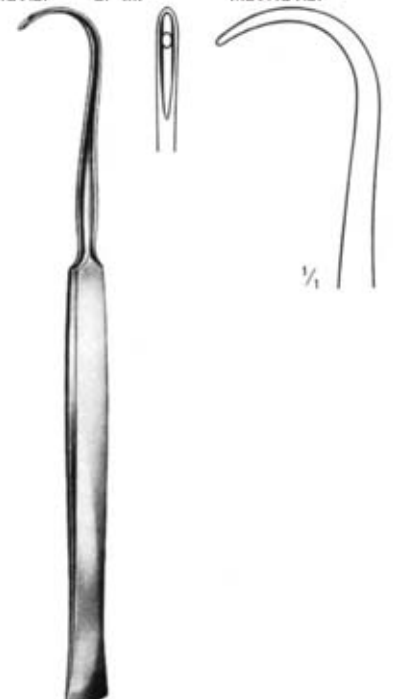

L	Cooper	R
M26.139.19	19 cm	



Naht-Instrumente  
Suturing Instruments  
Instruments à sutures  
Instrumentos para suturas  
Strumenti per suture



REVERDIN	cm	Fig. 1	Fig. 2	Fig. 3	Fig. 3
M26.201.15-M26.204.23	15	M26.201.15	M26.202.15	M26.203.15	M26.204.15
	19	M26.201.19	M26.202.19	M26.203.19	M26.204.19
	21	M26.201.21	M26.202.21	M26.203.21	M26.204.21
	15	M26.201.23	M26.202.23	M26.203.23	M26.204.23



YOUNG Boomerang  
M26.240.00  
25 cm



Fig. 1  
M26.240.01

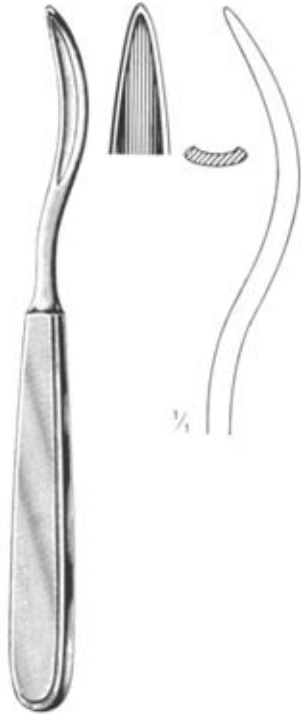

Fig. 2  
M26.240.02



Fig. 3  
M26.240.03

Führungs-Hohlsonden  
 Ligature Conductors  
 Sondes conductrices  
 Sondas conductoras  
 Sonde conduttrici



SCHMIEDEN  
 M26.271.19  
 19 cm



SCHMIEDEN-PAYR  
 M26.273.19  
 19 cm



BRUNER  
 M26.275.30  
 30 cm

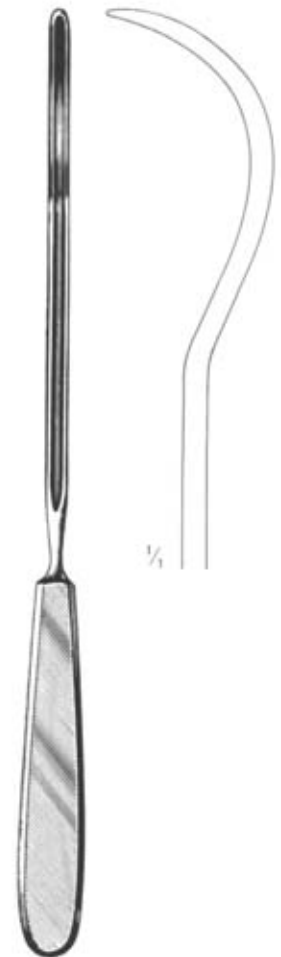

KIRSCHNER  
 M26.277.25  
 25,5 cm



KOEING  
 M26.285.20  
 20 cm



PAYR  
 M26.288.22  
 22 cm

PAYR  
 M26.289.22  
 22 cm



cm	BRUNNER
18	M26.291.18
27	M26.291.27

Plastik  
 from plastic material  
 matière plastique  
 de materia plástica  
 in plastica

Nähnadeln  
Suturing Needles  
Aiguilles à sutures  
Agujas para suturas  
Aghi per sutura

In Packungen zu q Dutzend  
in packages of 1 dozen  
en enveloppes de 1 douzaine  
en sobres de 1 douzaine  
busine di 1 douzina

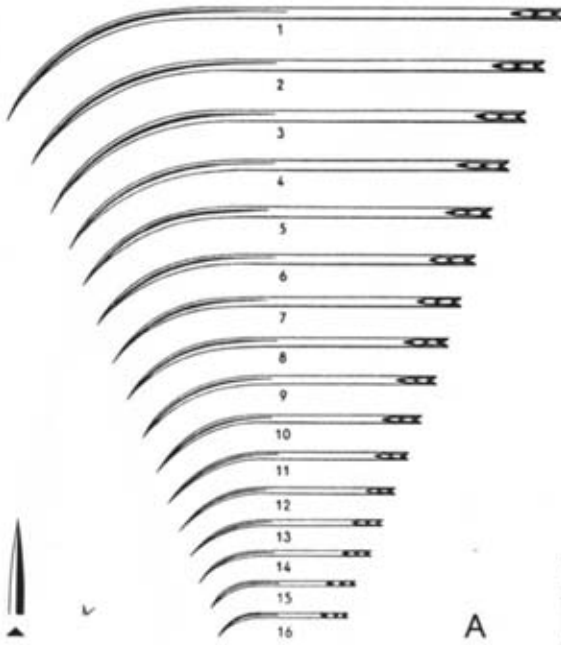

M26.403.01-M26.403.16

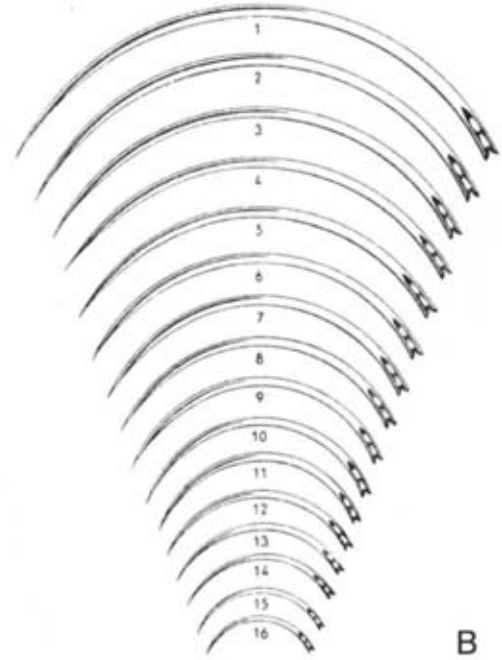

M26.413.01-M26.423.16

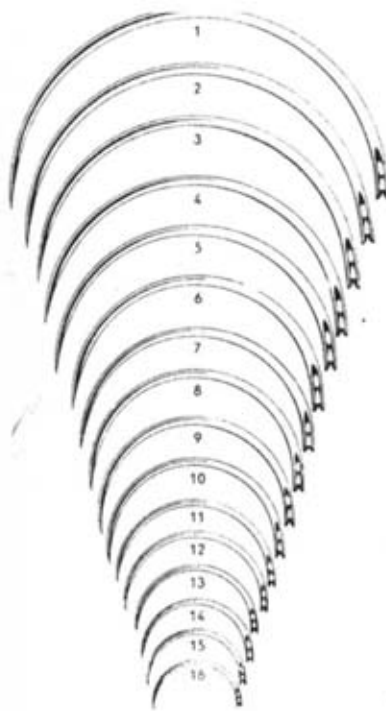

M26.423.01-M26.423.16

Alle Nadeln mit Gederühr  
all the needles with spring eye  
tutes les aiguilles à chas à ressort  
todas las agujas con ojo de resorte  
tutti gli aghi con cruna aperta

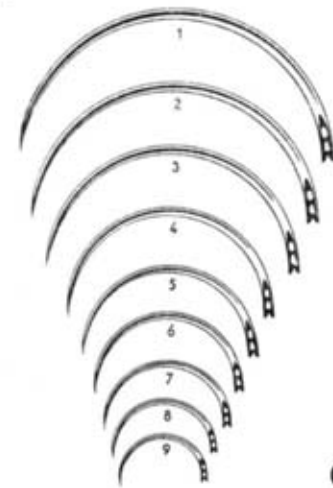

M26.433.01-M26.433.09

Fig.	1	2	3	4	5	6	7	8	9	10	11	12	13	14	15	16
A	M26.403.01	M26.403.02	M26.403.03	M26.403.04	M26.403.05	M26.403.06	M26.403.07	M26.403.08	M26.403.09	M26.403.10	M26.403.11	M26.403.12	M26.403.13	M26.403.14	M26.403.15	M26.403.16
B	M26.413.01	M26.413.02	M26.413.03	M26.413.04	M26.413.05	M26.413.06	M26.413.07	M26.413.08	M26.413.09	M26.413.10	M26.413.11	M26.413.12	M26.413.13	M26.413.14	M26.413.15	M26.413.16
G	M26.423.01	M26.423.02	M26.423.03	M26.423.04	M26.423.05	M26.423.06	M26.423.07	M26.423.08	M26.423.09	M26.423.10	M26.423.11	M26.423.12	M26.423.13	M26.423.14	M26.423.15	M26.423.16
Ga	M26.433.01	M26.433.02	M26.433.03	M26.433.04	M26.433.05	M26.433.06	M26.433.07	M26.433.08	M26.433.09	M26.433.10	M26.433.11	M26.433.12	M26.433.13	M26.433.14	M26.433.15	M26.433.16

Nähnadeln  
Suturing Needles  
Aiguilles à sutures  
Agujas para suturas  
Aghi per suture

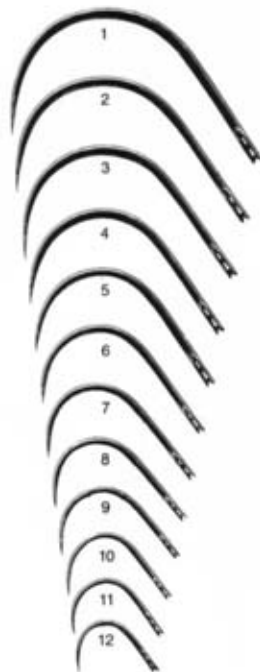

**KOENIG**  
M26.441.01-M26.441.12



**KEITH**  
M26.450.01-M26.450.06

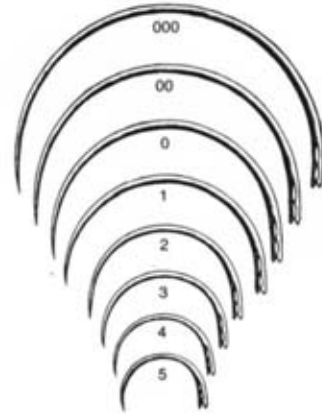

M26.443.30-M26.443.05

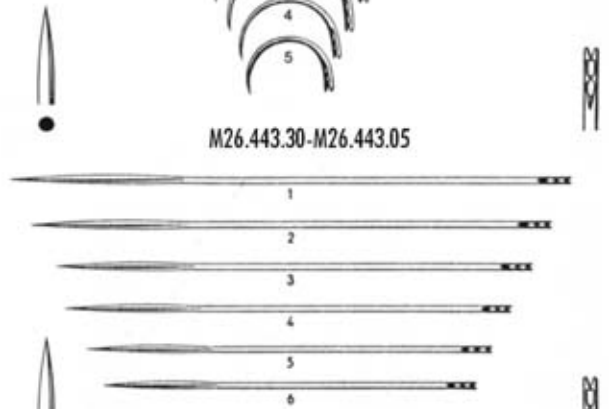

**KEITH**  
M26.452.01-M26.452.06

Alle Nadeln mit Federrohr  
all the needles with spring eye  
toutes les aiguilles à chas à ressort  
todas las agujas con ojo de resorte  
tutti gli aghi con cruna aperta

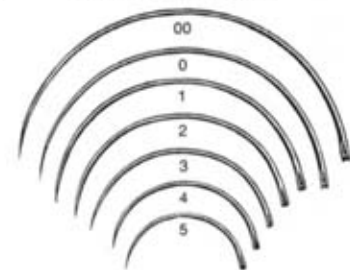

M26.465.20-M26.467.05

Pb

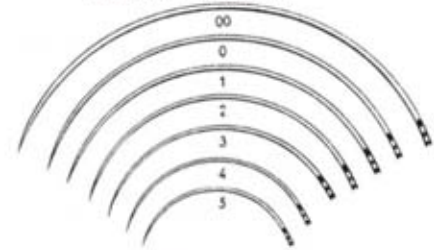

M26.48520-M26.487.05

Pd

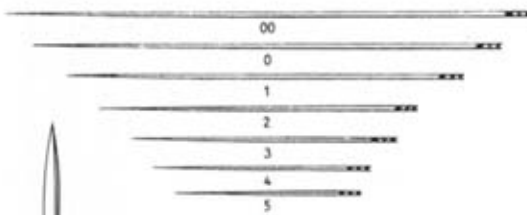

M26.475.20-M26.477.05

Pc

Fig.	000	00	0	1	2	3	4	5	6	7	8	9	10	11	12
KOENIG				M26.441.01	M26.441.02	M26.441.03	M26.441.04	M26.441.05	M26.441.06	M26.441.07	M26.441.08	M26.441.09	M26.441.10	M26.441.11	M26.441.12
E	M26.443.30	M26.443.20	M26.443.10	M26.443.01	M26.443.02	M26.443.03	M26.443.04	M26.443.05							
KEITH			M26.450.10	M26.450.01	M26.450.02	M26.450.03	M26.450.04	M26.450.05	M26.450.06						
KEITH				M26.467.01	M26.467.02	M26.467.03	M26.467.04	M26.467.05	M26.467.06						
Pb		M26.465.20	M26.465.10	M26.467.01	M26.467.02	M26.467.03	M26.467.04	M26.467.05							
Pc		M26.475.20	M26.475.10	M26.477.01	M26.477.02	M26.477.03	M26.477.04	M26.477.05							
Pd		M26.485.20	M26.485.10	M26.487.01	M26.487.02	M26.487.03	M26.487.04	M26.487.05							

Wundklammern, -instrumente  
Clips and Instruments  
Agrafes et instruments  
Agrafes e instrumentos  
Agrafes e strumenti



MICHEL  
M26.610.12  
12 cm



WACHENFELDT  
M26.612.12  
12,5 cm



WACHENFELDT  
M26.614.12  
12,5 cm



HEGENBARTH  
M26.616.12  
12,5 cm



CHILDE  
M26.620.18  
18 cm



MICHEL  
M26.630.12  
12 cm



MICHEL  
M26.631.13  
13 cm



COLLIN  
M26.640.13  
13 cm



RICHTER-HEATH  
M26.642.14  
14 cm



MICHEL

M26.660.07	17,5 x 1,75 mm
M26.660.11	11 x 2
M26.660.12	12 x 3
M26.660.14	14 x 3
M26.660.16	16 x 3
M26.660.18	18 x 3
M26.660.20	20 x 3
M26.660.22	22 x 3

M26.662.12

M26.662.14

M26.662.16

M26.662.18

M26.662.20

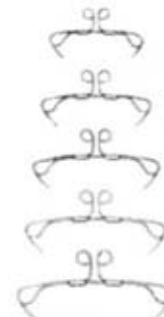

WACHENFELDT



Taschen-, Nahtbestecke  
Pocket, Suturing Kits  
Trousse à poche et à suture  
Estuche de bolsillo y de sutura  
Astucci tascabili e per sutura



Standard  
M26.680.00  
165 x 90 x 28



M26.670.00  
130 x 45 x 18 mm

Sterilisationsinstrumente  
Sterilization Instruments  
Instruments à stérilisation  
Instrumentos para la esterilización  
Strumenti per la sterilizzazione



cm DAVIS  
16 M28.102.16  
20 M28.102.20  
24 M28.102.24



CHEATLE  
M28.110.27  
27 cm



Universal  
M28.120.20 20 cm M28.121.20  
M28.120.28 28 cm M28.121.28



ROGGE  
M28.130.23  
23 cm



cm  
20 M28.140.20  
30 M28.140.30



BUNT  
M28.150.12  
12 cm

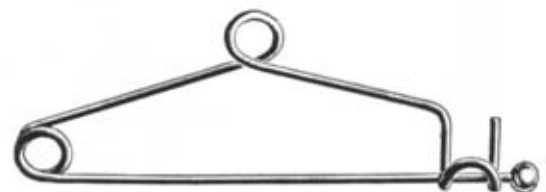

MAYO  
M28.162.14  
14 cm

Gipsverband  
Plaster of Paris  
Appareils plâtrés  
Vendajes enyesados  
Bendaggi gessati



STILLE  
M30.101.24  
24 cm



cm	STILLE
23	M30.103.23
26	M30.103.26
37	M37.103.37



WIGMORE  
M30.120.19  
19 cm



ENGEL  
M30.130.14



BERGMANN  
M30.134.18

Elektrische Gipssäge  
Electric Plaster Cast Cutter  
Scie électrique à plâtre  
Sierra eléctrica para yesos  
Sega elettrica per gessi

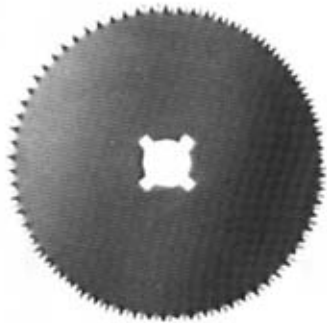

Volt	
110	M30.210.21
220	M30.210.22
	comp.

		Typ
50	M30.210.50	normal
50	M30.211.50	hart/hart/dure/dura
65	M30.210.65	normal
65	M30.211.65	hart/hard/dure/dura



M30.212.02



Gipsverband  
Plaster of Paris  
Appareils plâtrés  
Vendajes enyesados  
Bendaggi gessati



HENNIG  
M30.350.28  
28 cm



BEESON  
M30.360.30  
30 cm



HAGLUND-STILLE  
M30.362.28  
28 cm



M30.366.23  
23 cm



HOPKINS  
M30.370.20  
20 cm



ESMARCH  
M30.380.18  
18 cm



REINER  
M30.390.18  
18 cm



WOLFF  
M30.395.18  
18 cm



WOLFF  
M30.397.24  
-24 cm

Hohlmeißelzangen  
Bone Rongeurs  
Pinces-gouges  
Pinzas-gubias  
Pinze scorbie



FRIEDMAN Mini  
M32.101.12  
12 cm



FRIEDMAN  
M32.101.14  
14 cm



FRIEDMAN  
M32.102.14  
14 cm



CLEVELAND  
M32.103.14  
14 cm



CLEVELAND  
M32.105.17  
17 cm



MEAD  
M32.107.16  
16,5 cm



MEAD  
M32.109.16  
16,5 cm



BLUMENTHAL  
M32.115.15  
15,5 cm



BLUMENTHAL  
M32.117.15  
15,5 cm

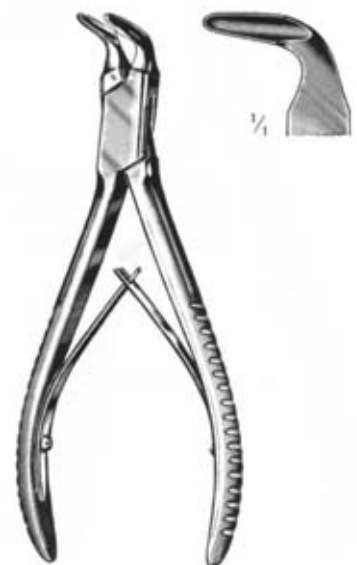

BLUMENTHAL  
M32.119.15  
15,5 cm

Hohlmeißelzangen  
Bone Rongeurs  
Pinces-gouges  
Pinzas-gubias  
Pinze sgorbie



LUER  
M32.131.15



LUER  
M32.133.15

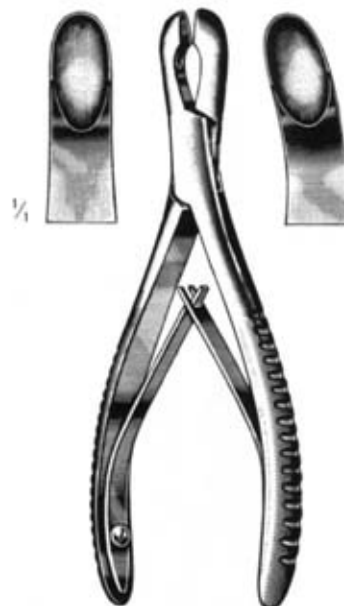

LUER  
M32.136.17 M32.137.17



ADSON  
M332.142.20 20 cm M32.143.20



OLIVECRONA  
M32.147.20  
20 cm



LEMPERT  
M32.150.16 16 cm M32.161.16



LEMPERT  
M32.154.18 18,5 cm M32.155.18

Hohlmeißelzangen  
Bone Rongeurs  
Pincés-gouges  
Pinzas-gubias  
Pinze scorbie



BEYER  
M32.201.18  
18 cm



ZAUFAL-JANSEN  
M32.205.18  
18 cm



BÖHLER  
M32.216.18 18 cm M32.213.15



RUSKIN  
M32.216.18 18 cm M32.217.18



RUSKIN  
M32.219.23  
23 cm



STILLE-LUER  
M32.230.22 22 cm M32.231.22  
M32.230.26 26 cm M32.231.26



STILLE-LUER  
M32.235.23  
23 cm

Hohlmeißelzangen  
 Bone Rongeurs  
 Pincès-gouges  
 Pinzas-gubias  
 Pinze sgorbie



STILLE-RUSKIN  
 M32.237.23  
 23 cm

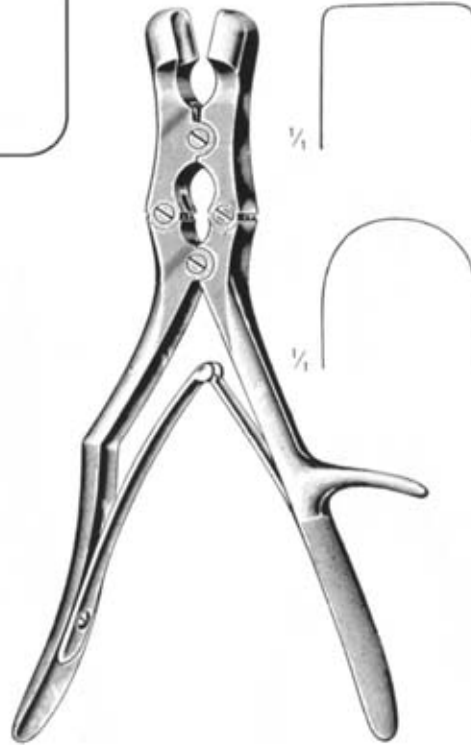

Fig. SAUERBRUCH  
 1 M32.241.30  
 2 M32.243.30  
 30 cm



Fig. LEKSELL (STILLE)  
 1 M32.245.23  
 2 M32.247.23  
 23 cm



R M32.251.26  
 à droite  
 derecha  
 a destra

SCAGLIETTI  
 26 cm M32.253.26  
 à gauche  
 izquierda  
 a sinistra



FRYKHOLM  
 M32.255.24



ECHLIN  
 M32.259.23  
 23 cm

Knochensplitterzangen  
Bone Cutting Forceps  
Pinces coupantes à os  
Pinzas cortantes para huesos  
Cesoie per ossa



SEMB  
M32.261.22  
22,5 cm

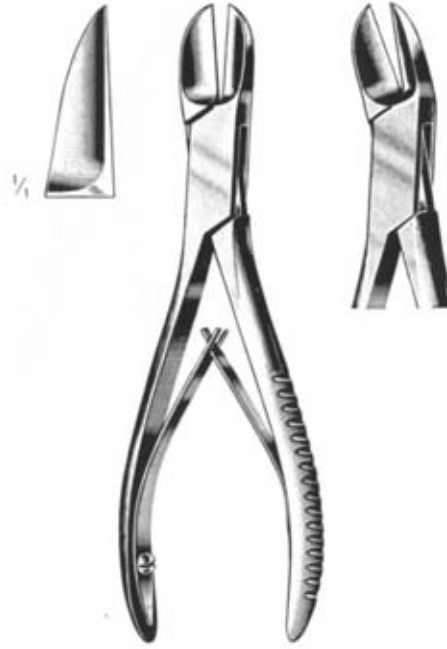

LISTON  
M32.274.14 14 cm M32.275.14  
M32.274.17 17 cm M32.275.17  
M32.274.19 19 cm M32.275.19  
M32.274.22 22 cm M32.275.22



BÖHLER  
M32.280.15 15 cm M32.281.15



CLOTTLE-KAZANJIAN  
M32.282.19  
19 cm



RUSKIN-LISTON  
M32.286.18 18,5 cm M32.289.18

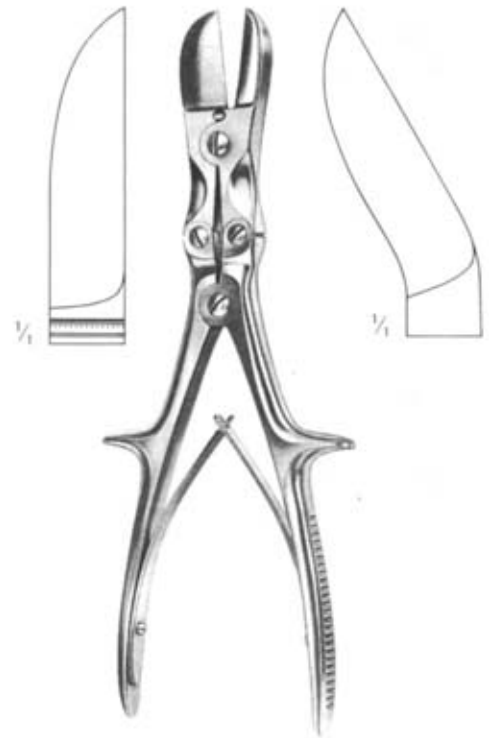

STILLE-LISTON  
M32.290.27 27 cm M32.291.27

Knochensplitterzangen  
 Bone Cutting Forceps  
 Pincès coupantes à os  
 Pinzas cortantes para huesos  
 Cesioie per ossa



STILLE-HORSLEY  
 M32.293.27  
 27 cm

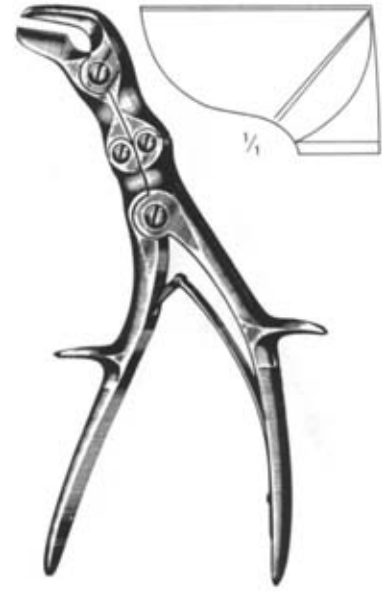

SEMB  
 M32.295.24  
 24 cm

Knochenhalterzangen  
 Bone Holding Forceps  
 Daaviers porte-os  
 Pinzas para huesos  
 Tenaglie per ossa

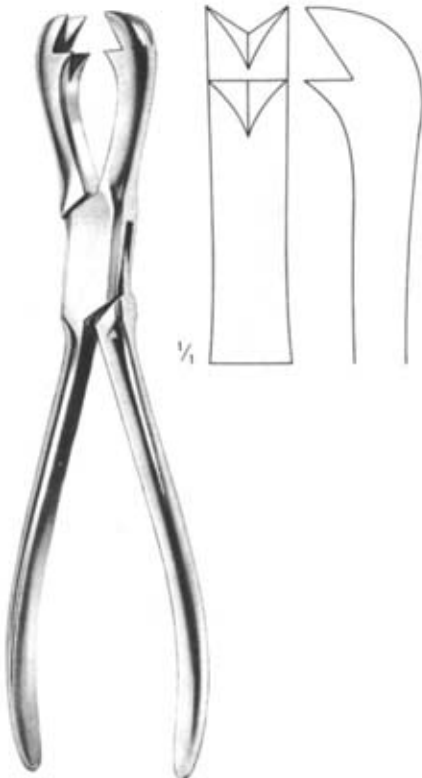

FERGUSSON  
 M32.360.21  
 21 cm



LANGENBECK  
 M32.362.21  
 21 cm

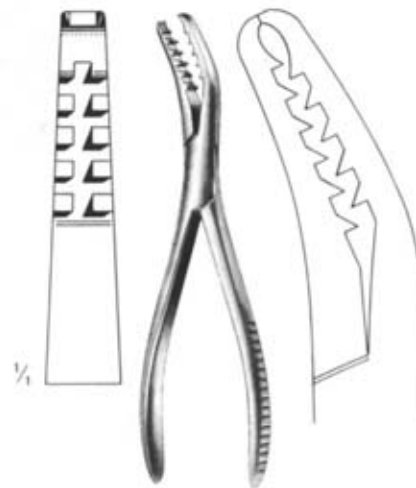

SEMB  
 M32.365.19  
 19 cm



cm FARABEU  
 23 M32.366.23  
 26 M32.366.26

Knochenhalte­zangen  
Bone Holding Forceps  
Daviers porte-os  
Pinzas para huesos  
Tenaglie per ossa



**FARABEUF-LAMBOTTE**  
M32.368.26  
26 cm



cm **LAMBOTTE**  
22 M32.370.22  
27 M32.370.27  
30 M32.372.33



cm **LAMBOTTE**  
22 M32.372.22  
26 M32.372.26  
33 M32.372.33



cm **LAMBOTTE**  
19 M32.372.19  
23 M32.372.23  
26 M32.373.26



cm **KERN**  
15 M32.378.15  
17 M32.378.17  
21 M32.278.21

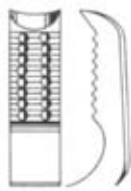

**KERN**  
M32.380.15  
M32.380.17  
M32.380.21

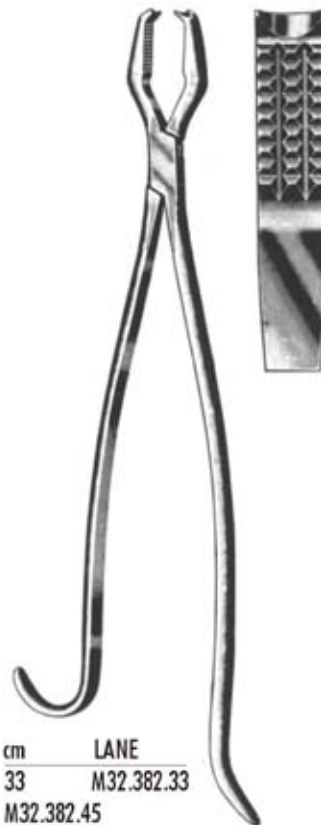

cm **LANE**  
33 M32.382.33  
M32.382.45

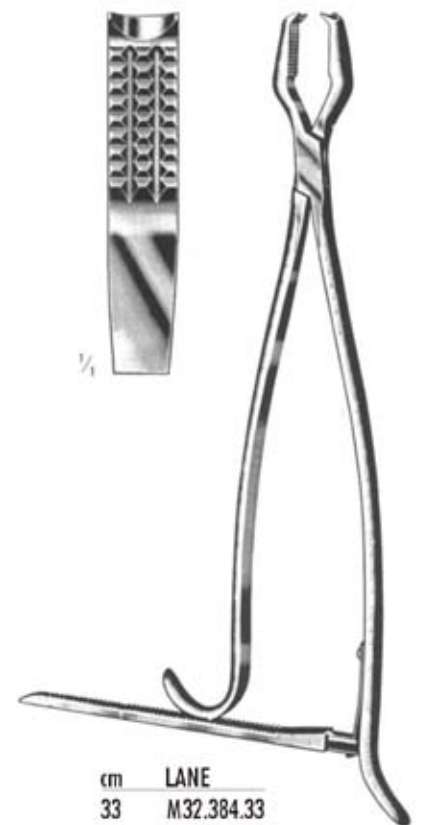

cm **LANE**  
33 M32.384.33  
45 M32.384.45



Knochenhalte­zangen  
Bone Holding Forceps  
Daviers porte-os  
Pinzas para huesos  
Tenaglie per ossa



M32.391.15 - M32.391.28

Selbstzentrierend  
self-centering  
autocentrant  
autocentrantes  
autocentranti



M33.391.15  
15 cm



M32.391.19  
19 cm



M32.391.24  
24 cm

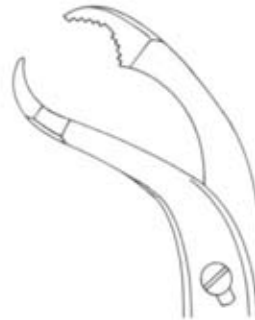

M32.391.26  
26 cm



M32.391.28  
28 cm

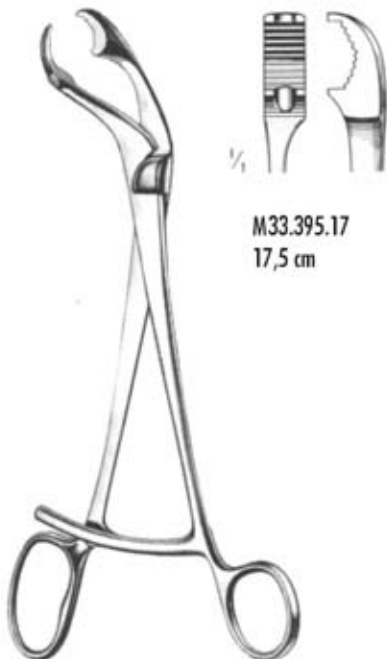

VERBRUGGE  
M32.395.17 - M32.395.27



M33.395.17  
17,5 cm

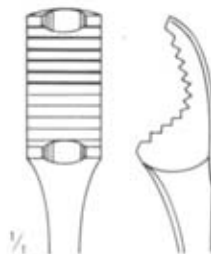

M32.395.25  
25 cm

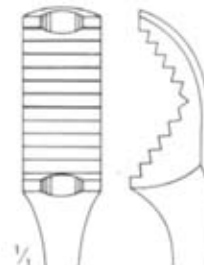

M32.395.26  
26 cm

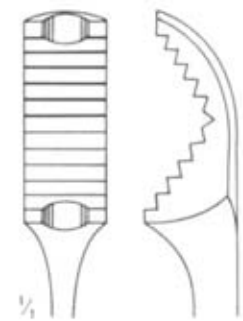

M32.395.27  
27 cm

Knochenhalte-, Sequesterzangen  
Bone Holding, Sequester Forceps  
Pinces à os, à séquestres  
Pinzas para huesos y secuestros  
Pinze per ossa e sequestri

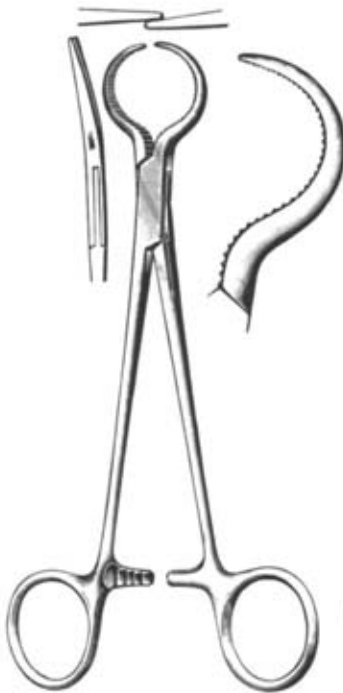

LEWIN  
M32.402.17  
17,5 cm



BERCHER-GANSKE  
M32.404.20 20 cm M32.405.20

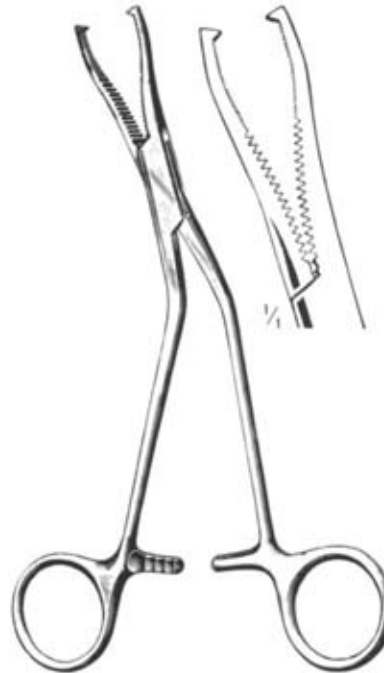

DINGMANN  
M32.407.19  
19 cm



M32.409.13  
13,5 cm



MARTIN  
M32.410.19  
19 cm

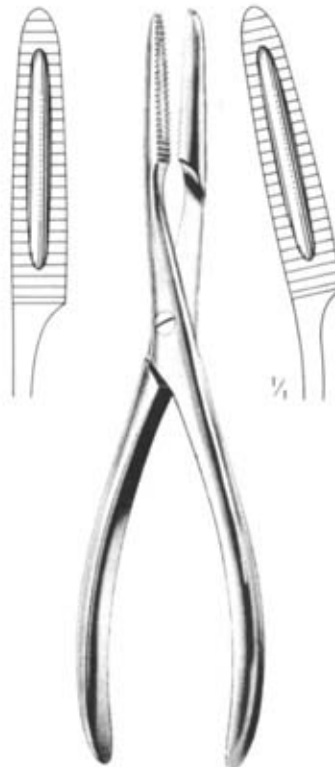

M32.420.20 20 cm M32.421.20

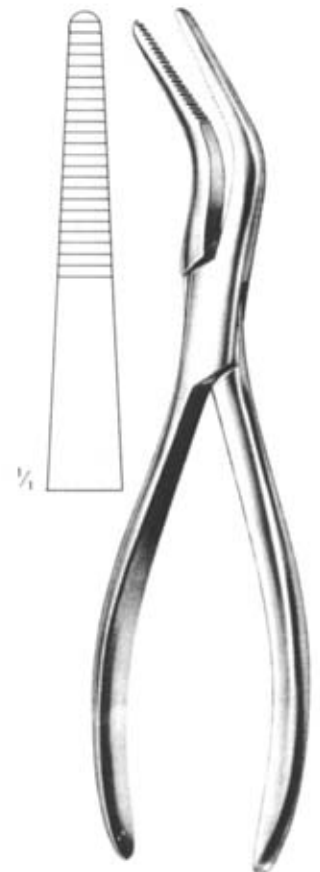

VAN BUREN  
M32.423.23  
23 cm

Knochenchirurgie  
 Bone Surgery  
 Chirurgie osseuse  
 Cirugía ósea  
 Chirurgia ossea

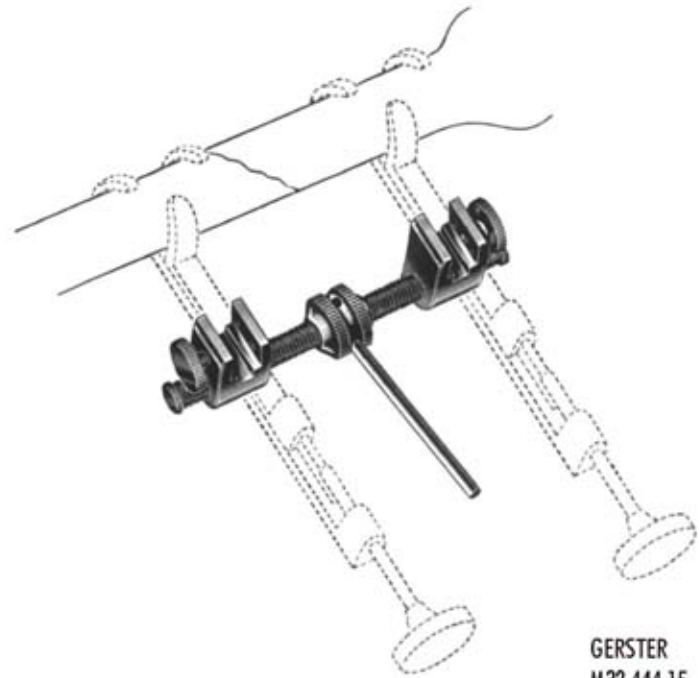

GERSTER  
 M32.444.15

cm LOWMAN  
 13 M32.441.13  
 18,5 M32.441.18  
 20 M32.441.20

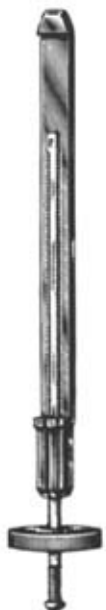

PARHAM  
 M32.446.24



PARHAM  
 18 cm M32.448.18  
 30 cm M32.448.30

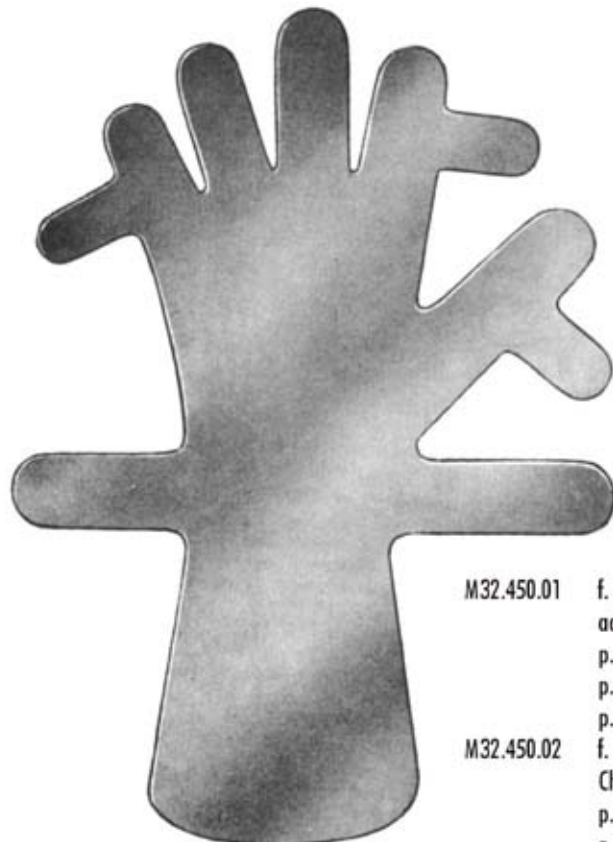

M32.450.01 f. Erwachsene  
 adult size  
 p. Adultes  
 p. Adultos  
 p. Adulti  
 M32.450.02 f. Kinder  
 Child size  
 p. Enfants  
 p. Niños  
 p. Bambini

Scharfe Löffel  
Bone Currettes  
Curettes à os  
Cucharillas cortantes  
Curette taglienti

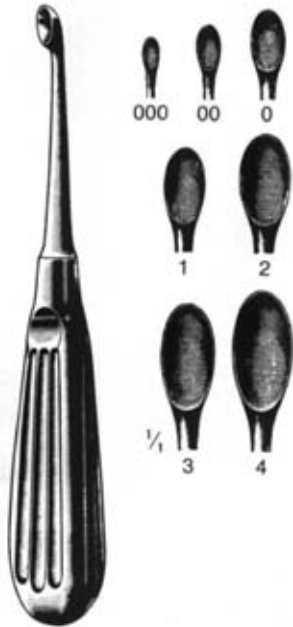

**SCHEDE**  
M32.467.97-M32.468.04

SCHEDE	Fig.	VOLKMANN
	0000	M32469.96
M32.467.97	000	M32469.97
M32.467.98	00	M32470.98
M32.467.00	0	M32470.00
M32.467.01	1	M32470.01
M32.467.02	2	M32470.02
M32.467.03	3	M32470.03
M32.467.04	4	M32470.04
M32.467.05	5	M32470.05
	6	M32.470.06

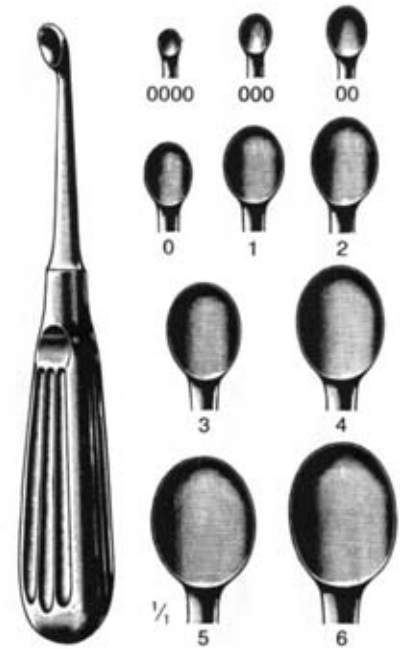

**VOLKMANN**  
M32.469.96-M32.470.06

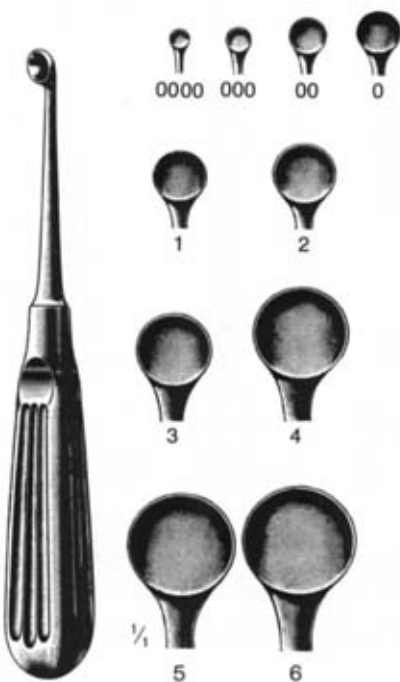

**BRUNS**  
M32.471.96-M32.472.06

BRUNS	Fig.	SPRATT
M32.471.96	0000	
M32.471.97	000	M32.474.97
M32.471.98	00	M32.474.98
M32.471.00	0	M32.475.00
M32.471.01	1	M32.475.01
M32.471.02	2	M32.475.02
M32.471.03	3	M32.475.03
M32.471.04	4	M32.475.04
M32.471.05	5	M32.475.05
M32.471.06	6	M32.475.06

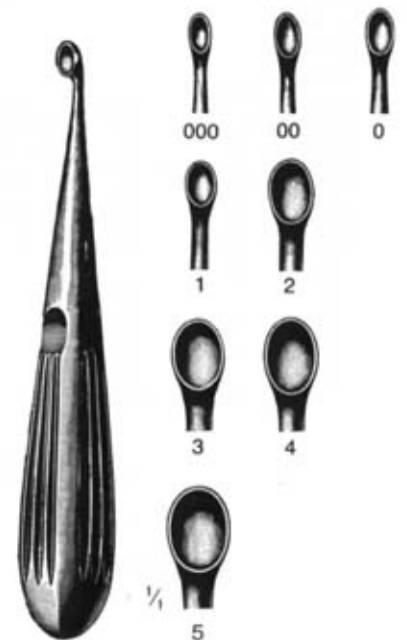

**SPRATT**  
M32.474.97-M32.475.05

Scharfe Löffel  
Bone Curettes  
Curettes à os  
Cucharillas cortantes  
Curette taglienti

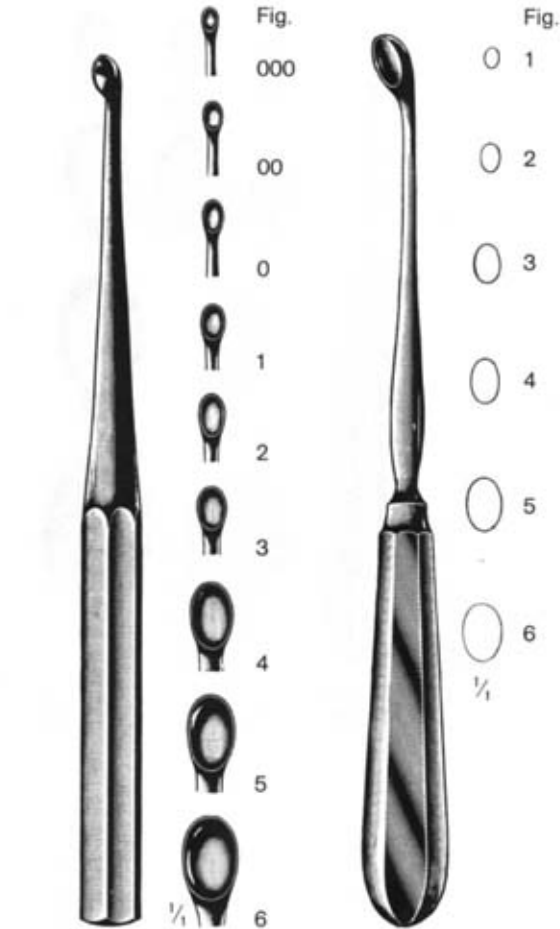

Fig.	BRUNS 23 cm	SIMON 24 cm
000	M32.480.97	
00	M32.480.98	
0	M32.481.00	
1	M32.481.01	M32.485.01
2	M32.481.02	M32.485.02
3	M32.481.03	M32.485.03
4	M32.481.04	M32.485.04
5	M32.481.05	M32.485.05
6	M32.481.06	M32.485.06

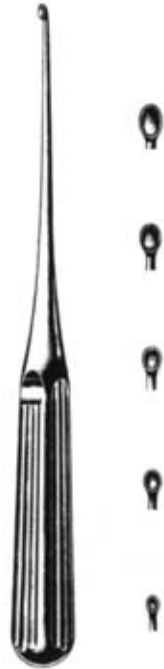

Fig.	LEMPERT 17,5 cm
0	M32.490.10
00	M32.490.20
000	M32.490.30
0000	M32.490.40
00000	M32.490.50

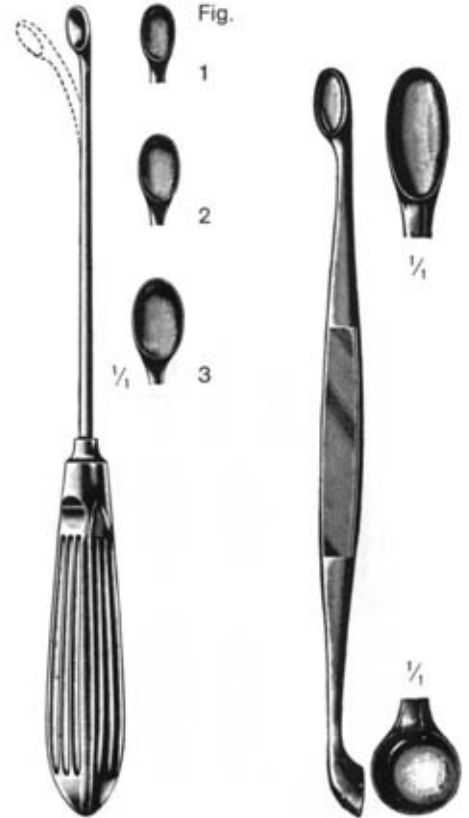

Fig.	HALLE 21 cm
1	M32.491.01
2	M32.491.02
3	M32.491.03

cm	VOLKMANN
13	M32.42.13
16	M32.492.16
20	M32.492.20



cm	VOLKMANN
13	M32.494.13
14	M32.494.14
17	M32.494.17

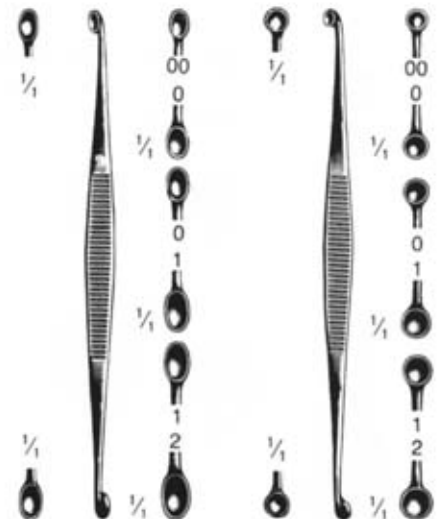
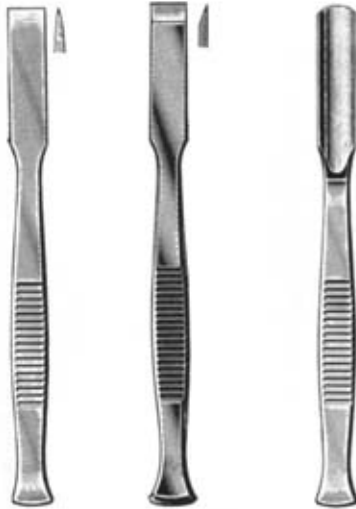

Fig.	WILLIGER 13,5 cm
00/0	M32.496.00
0/1	M32.496.01
1/2	M32.496.12

Fig.	MARTINI 13,5 cm
00	M32.498.00
0	M32.498.01
1	M32.498.12
2	M32.498.12

**Knochenmeißel  
Bone Chisels and Gouges  
Ciseaux-burins, gouges  
Cinceles, gubias  
Scalpelli, sgorbie**



mm	13,5 cm	13,5 cm	13,5 cm
4			
6			
8	M32.602.08	M32.604.08	M32.605.08
10	M32.602.10	M32.604.10	M32.605.10
12	M32.602.12	M32.604.12	M32.605.12
14	M32.602.14	M32.604.14	M32.605.14
16	M32.602.16	M32.604.16	M32.605.16

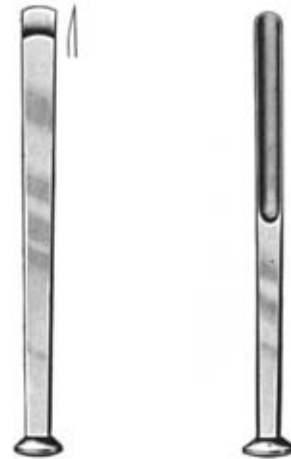

ALEXANDER		ALEXANDER	
17 cm		17 cm	
M32.610.04	M32.611.04	M32.611.04	M32.611.04
M32.610.06	M32.611.06	M32.611.06	M32.611.06
M32.610.08	M32.611.08	M32.611.08	M32.611.08
M32.610.10	M32.611.10	M32.611.10	M32.611.10
M32.610.12	M32.611.12	M32.611.12	M32.611.12
M32.610.14	M32.611.14	M32.611.14	M32.611.14
M32.610.16	M32.611.16	M32.611.16	M32.611.16

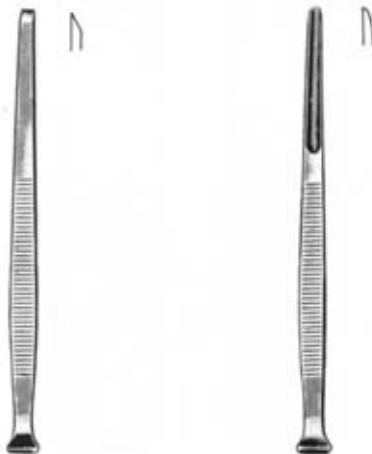

PARTSCH		PARTSCH		
mm	13,5 cm	17 cm	13,5 cm	17 cm
2	M32.620.02	M32.622.02	M32.623.02	M32.625.02
3	M32.620.03	M32.622.02	M32.623.03	M32.625.03
4	M32.620.04	M32.622.02	M32.623.04	M32.625.04
5	M32.620.05	M32.622.02	M32.623.05	M32.625.05
6	M32.620.06	M32.622.02	M32.623.06	M32.625.06
7	M32.620.07	M32.622.02	M32.623.07	M32.625.07

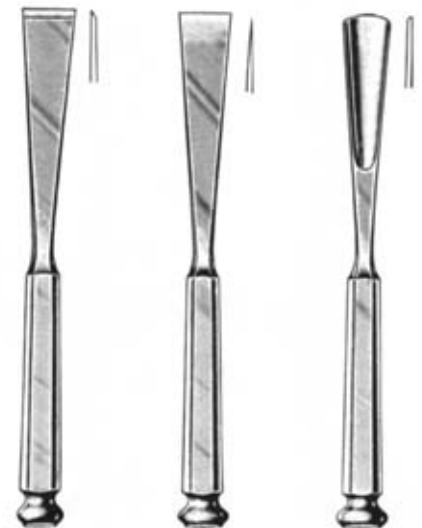

STILLE		STILLE		STILLE	
mm	20 cm	20 cm	20 cm	20 cm	20 cm
10	M32.630.10	M32.632.10	M32.633.10	M32.633.10	M32.633.10
15	M32.630.15	M32.632.15	M32.633.15	M32.633.15	M32.633.15
20	M32.630.20	M32.632.20	M32.633.20	M32.633.20	M32.633.20
25	M32.630.25	M32.632.25	M32.633.25	M32.633.25	M32.633.25

Knochenmeißel  
 Bone Chisels and Gouges  
 Ciseaux-burins, gouges  
 Cinceles, gubias  
 Scalpelli, sgorbie



mm	SMITH-PETERSEN			
6	M32.634.06	M32.634.06	M32.637.06	M32.639.06
9	M32.634.09	M32.634.09	M32.637.09	M32.639.09
13	M32.634.13	M32.634.13	M32.637.13	M32.639.13
16	M32.634.16	M32.634.16	M32.637.16	M32.639.16
19	M32.634.19	M32.634.19	M32.637.19	M32.639.19
25	M32.634.25	M32.634.25	M32.637.25	M32.639.25
32	M32.634.32	M32.634.32	M32.637.32	M32.639.31
	20 cm	20 cm	20 cm	

mm	LAMBOTTE		LAMBOTTE mini	
6,5	M32.650.06	M32.651.06	3	M32.654.03
15,5	M32.650.15	M32.651.15	4	M32.654.04
20,0	M32.650.20	M32.651.20	6	M32.654.06
25,0	M32.650.25	M32.651.25	8	M32.654.08
30,0	M32.650.30	M32.651.30	10	M32.654.10
38,0	M32.650.38	M32.651.38	12	M32.654.12
44,0	M32.650.44	M32.651.44	15	M32.654.15
	24 cm	23 cm		12,5 cm

Knochenmeißel  
 Bone Chisels and Gouges  
 Ciseaux-burins, gouges  
 Cinceles, gubias  
 Scalpelli, sgorbie



mm	LEXER	LEXER
7	M32.660.07	M32.661.07
10	M32.660.10	M32.661.10
15	M32.660.15	M32.661.15
20	M32.660.20	M32.661.20
25	M32.660.25	M32.661.25
30	M32.660.30	M32.661.30
	22 cm	22 cm

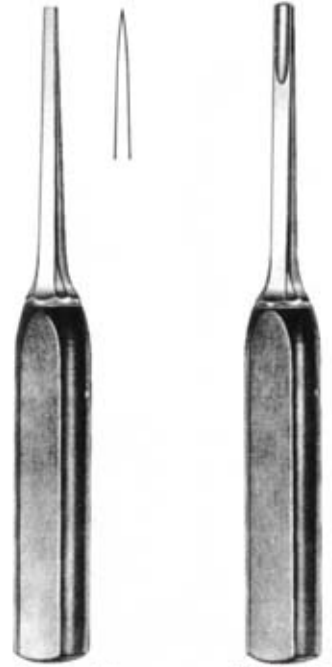

mm	LEXER mini	LEXER mini
4	M32.664.04	M32.665.04
6	M32.664.06	M32.665.06
8	M32.664.08	M32.665.08
10	M32.664.10	M32.665.10
12	M32.664.12	M32.665.12



mm	HOKE
3	M32.668.03
5	M32.668.05
6	M32.668.06
8	M32.668.08
9	M32.668.09
	17 cm

mm	HIBBS				
6	M32.670.06	M32.672.06	M 32.671.06	M32.673.06	M32.675.06
13	M32.670.13	M32.672.13	M 32.671.13	M32.673.13	M32.675.13
19	M32.670.19	M32.672.19	M 32.671.19	M32.673.19	M32.675.19
25	M32.670.25	M32.672.25	M 32.671.25	M32.673.25	M32.675.25
32	M32.670.32	M32.672.32	M 32.671.32	M32.673.32	M32.675.32
	24 cm	24 cm	24 cm	24 cm	24 cm



Knochenmeißel  
Bone Chisels and Gouges  
Ciseaux-burins, gouges  
Cinceles, gubias  
Scalpelli, sgorbie



LEBSCHKE  
M32.678.24  
24,5 cm



M32.679..22  
22 cm



VIRCHOW  
M32.680.12



BRUNETTI  
M32.681.28  
28 cm



BRUNETTI  
M32.638.28  
28 cm

Autopsie-Besteck  
Post Mortem Set  
Set à autopsie  
Juego de autopsia  
Set per autopsia



M32.684.00

Hämmer  
Bone Hammers and Mallets  
Maillets  
Martillos y mazos  
Martelli



GERZOG  
M32.686.25  
18 cm 250 g



KRIK  
M32.688.75  
19 cm 750 g



g  
450 M32.690.45  
900 M32.690.90  
26,5 cm



COLLIN  
M32.692.22  
20 cm 220 g



WILLIGER  
M32.694.34  
24 cm 340 g

M32.697.02  
Paar Ersatzbacken  
Pair of Spare Faces  
Paire de faces de rechange  
Pareja de tapas intercambiables  
Coppia di teste di ricambio



LUCAE  
M32.696.26  
19 cm 260 g



MEAD  
M32.696.32  
17 cm 320 g



g  
250 M32.698.25  
400 M32.68.40  
26 cm



QUISLING  
M32.698.75



M32.699.00  
23,5 cm

Raspatorien  
 Periosteal Elevators  
 Rugines-raspatoires  
 Periostótomos  
 Periostotomi

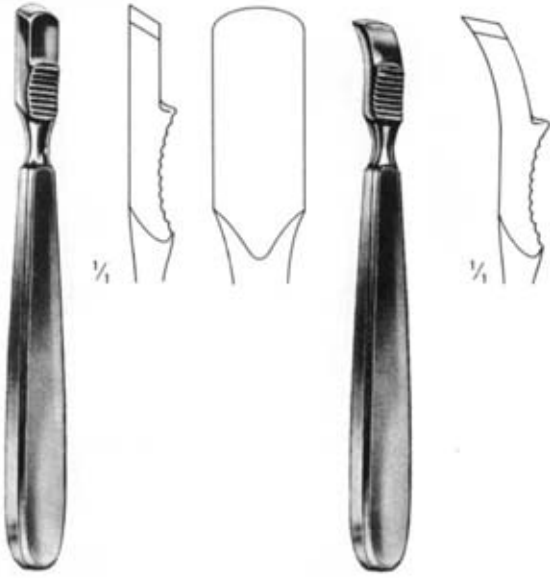

FARABEU  
 M32.702.15  
 15 cm

FARABEU  
 M32.703.15  
 15 cm



mm	LAMBOTTE
10	M32.705.10
15	M32.705.15
20	M32.705.25
25	M32.705.25
	21 cm

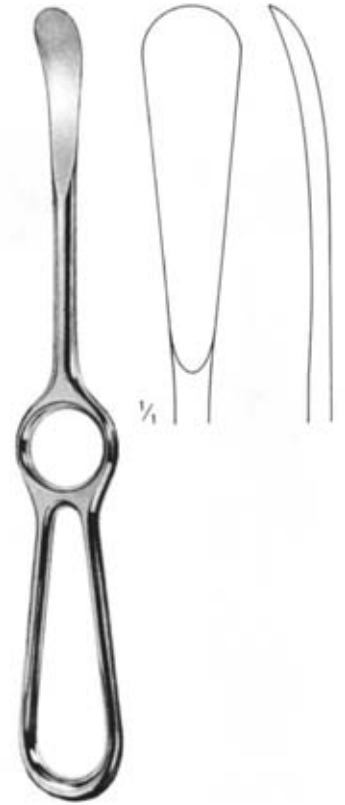

SEDILLOT  
 M32.709.21  
 21 cm

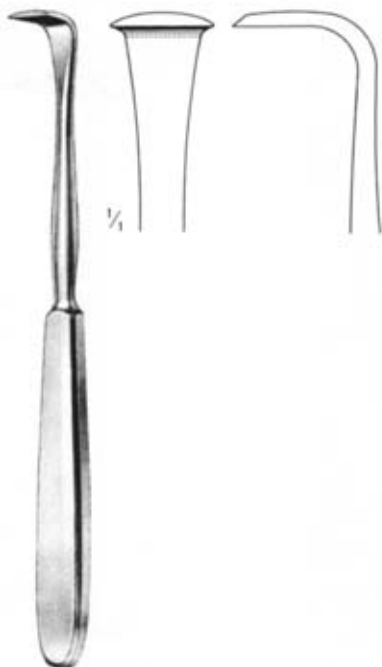

LANGENBECK  
 M32.711.18  
 18 cm



WILLIGER  
 M32.713.16  
 16 cm

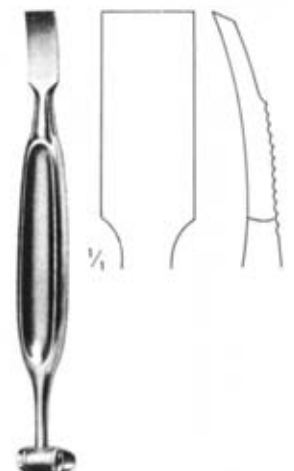

cm	ALEXANDER
16	M32.715.16
20	M32.715.20

Raspatorien  
Periosteal Elevators  
Rugines-raspatoires  
Periostótomos  
Periostotomi

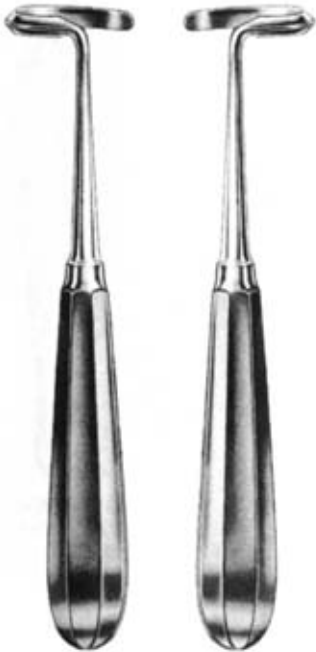

DOYEN M32.721.17  
DOYEN M32.727.17

17 c



M32.721.17

M32.723.17



M32.725.17

M32.727.17



SEMB

M32.739.01- M32.729.07



1/2

M32.729.01  
17,5 cm



M32.729.02  
21 cm



M32.729.03  
17,5 cm



M32.729.04  
21 cm



M32.729.05  
10,5 cm



M32.729.06  
20,5 cm



M32.729.07  
22,5 cm

Elevatorien  
Elevators  
Elévateurs  
Elevadores  
Elevatori



**MATSON-ALEXANDER**  
M32.731.22



**MATSON**  
M32.733.22  
22 cm



**OVERHOLT**  
M32.735.29  
29,5 cm



**OVERHOLT**  
M32.737.29  
29,5 cm



**OVERHOLT**  
M32.739.28  
28,5 cm



**LANGENBECK**  
M32.751.20  
2k0 cm



**LANGENBECK**  
M32.753.20  
20 cm



**ADSON**  
M32.754.17-M32.757.17  
17 cm



M32.745.17



M32.755.17



M32.756.17



M32.757.17



**KEY**  
M32.759.06-M32.759.25  
19 cm



6 mm	M32.759.06
12	M32.759.12
19	M32.759.19
25	M32.759.25

Elevatorien, Knochenheber  
Elevators, Bone Levers  
Elévateurs, Leviers à os  
Elevadores, E. para huesos  
Elevatori, Elevatori per ossa



**WATSON-CHEYNE**  
M32.765.17  
17,5 cm



**McDONALD**  
M32.767.19  
19 cm



**MURPHY-LANE**  
M32.769.30  
30 cm



**BENNETT**  
M32.771.71  
65 x 260 mm



**BENNETT**  
M32.771.73  
45 x 260 mm

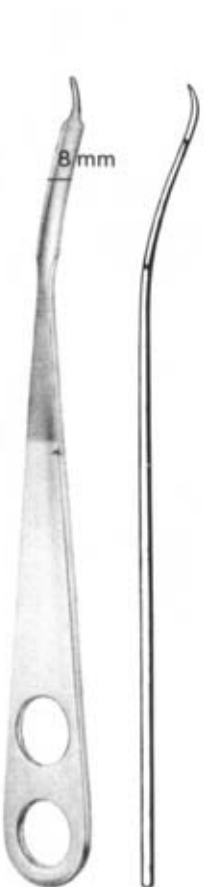

**HOHMANN**  
M32.801.08  
8 mm

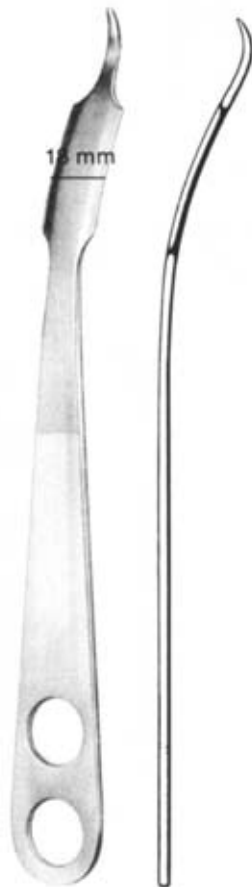

**HOHMANN**  
M32.801.18  
18 mm

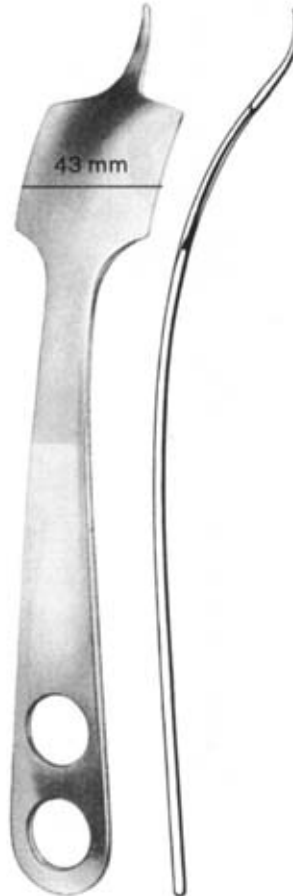

**HOHMANN**  
M32.801.43  
43 mm



**HOHMANN**  
M32.801.70  
70 mm

Knochenheber  
 Bone Levers  
 Leviers à os  
 Elevadores para huesos  
 Elevatori per ossa



HOHMANN  
 M32.803.43  
 43 mm



HOHMANN mini  
 M32.811.06-M32.811.08  
 16 cm

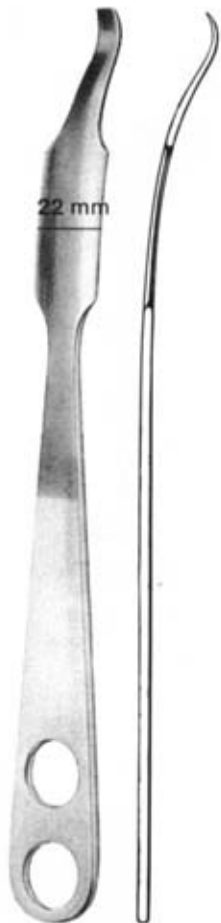

HOHMANN  
 M32.805.22  
 22 mm



M32.811.08  
 8 mm



HOHMANN  
 M32.805.22  
 33 mm



HOHMANN  
 M32.807.24  
 24 mm

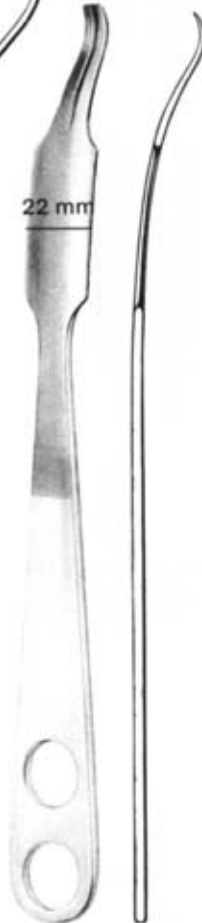

HOHMANN  
 M32.809.22  
 22 mm

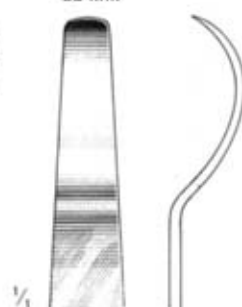

M32.815.06  
 14 cm

M32.811.06  
 6 mm

Knochenhebel  
Bone Levers  
Leviers à os  
Elevadores para huesos  
Elevatori per ossa

Knochenchirurgie  
Bone Surgery  
Chirurgie osseuse  
Chirurgia ósea  
Chirurgia ossea



BLOUNT  
M32.823.26  
26 cm

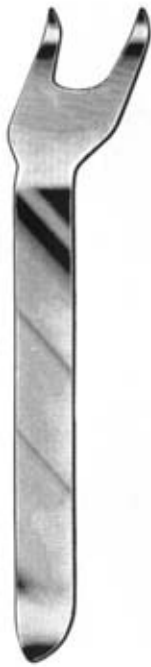

BLOUNT  
M32.825.26  
26 cm

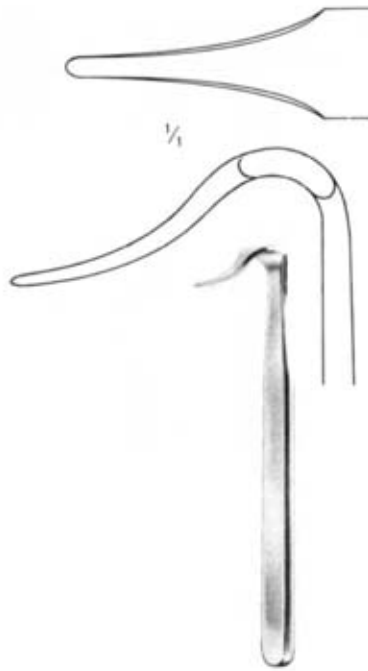

BLOUNT  
M32.827.17  
17,5 cm



mm x mm TYLOR  
75 x 30 M32.831.16  
100 x 30 M3833.16  
16,5 cm

Meniskontome . Meniscotomes  
Meniscotomes . Meniscotomos  
Meniscotomi



SMILLE  
M32.910.17  
17 cm



M32.911.17  
17 cm



M32.913.17  
17 cm



BIRCHER  
M32.915.19  
19 cm



BIRCHER  
M32.917.19  
19 cm

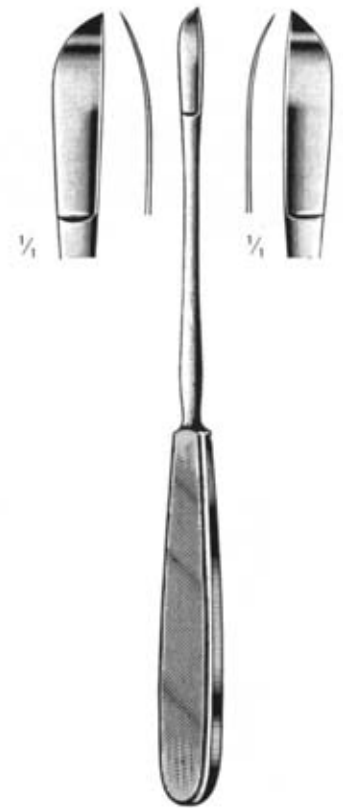

NEFF  
M32.921.22 22 cm M32.933.22



Knochenchirurgie  
Bone Surgery  
Chirurgie osseuse  
Cirugía ósea  
Chirurgia ossea

Sehnenstripper, Knochenfilen  
Tendon Strippers, Bone Files  
Instruments à écorcher les tendon, leimes à os  
Separadores para tendones, limas para huesos  
Scollatendini, lime per ossa



BUNNELL  
M32.950.01-M32.950.05  
15 cm



M32.971.24  
24,5 cm



M32.972.22  
22 cm



PUTTI  
27 cm



PUTTI  
30 cm

Komprimeter zur Erzeugung von Bluteere in den Gliedern  
Compression Apparatus for producing blood vacuum in limbs  
Appareil compesif permenttant d'obtenir un milieu exsangue des membres  
Aparato de compresion para producir el vacio de sangre en los miembros  
vacumentro per determinare vueti di sangue nelle membra



M33.101.01  
comp.

Amputation, Finger  
Amputation, Fingers  
Amputation, doigts  
Amputación, dedos  
Amputazione, dita

3 mm M33.112.03  
5 mm M33.112.05  
7 mm M33.112.07

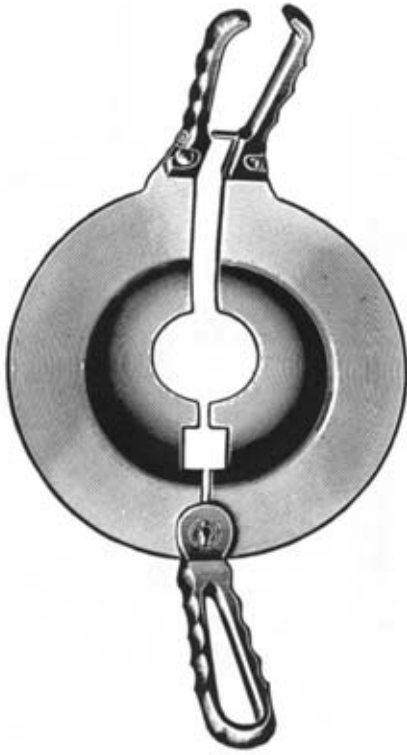

PERCY  
M33.110.00

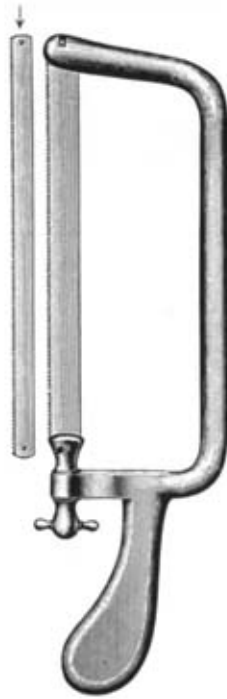

CHARRIERE  
M33.112.00



CHARRIERE  
M33.116.30  
30 cm



SATTERLLE  
M33.118.31  
31 cm



LANGENBECK  
M33.120.23  
23 cm



M33.160.01



M33.160.00  
Comp. Incl.  
M33.160.01



RADOLF  
M33.162.13  
13,5 cm



M33.173.01

M33.173.00  
17 cm



M33.175.01

M33.175.00

Handbohrapparate  
 Bone Hand Drills  
 Perforateurs à main  
 Perforadores a mano  
 Perforatori a mano

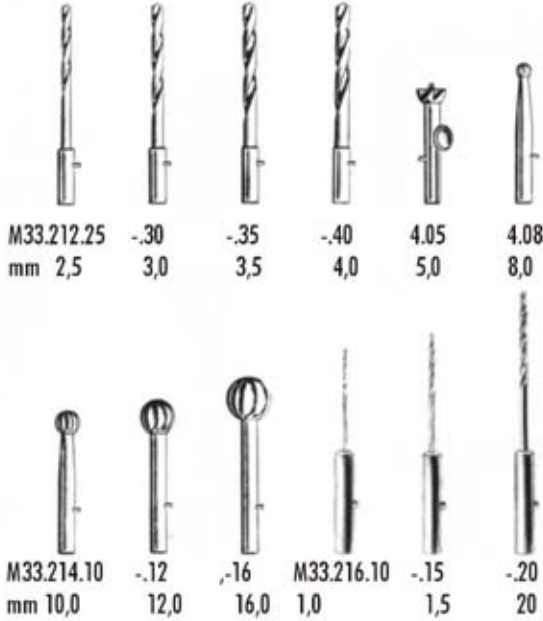

M33.212.25 -30 -35 -40 4.05 4.08  
 mm 2,5 3,0 3,5 4,0 5,0 8,0

M33.214.10 -12 -16 M33.216.10 -15 -20  
 mm 10,0 12,0 16,0 1,0 1,5 20

STILLE  
 M33.210.20  
 Compl. 0 cm



M33.222.25 -30 -35  
 mm 2,5 3,0 3,5

STILLE-SHERMAN  
 M33.220.24  
 Compl. 24 cm

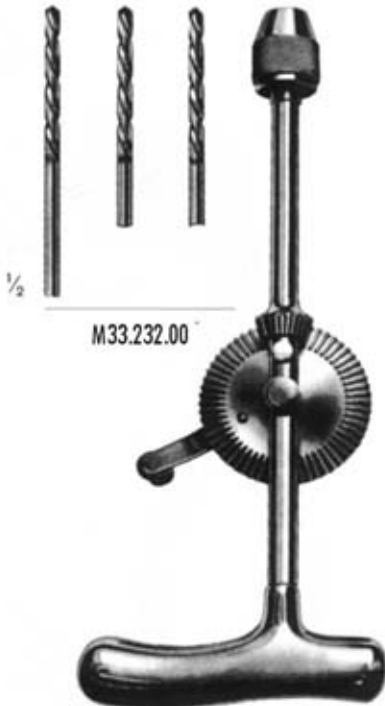

M33.232.00

MOORE  
 M33.230.28  
 Compl. 28 cm



1/8 M33.242.09 1/8 M33.242.14 1/8 M33.242.16 1/8 M33.242.22  
 mm 9 14 16 22

HUDSON  
 M33.240.27  
 Compl. Incl. M33.242.09, -14, -16, M33.246.00  
 27 cm



1/8 CUSHING M33.244.14 M33.246.00 MCKENZIE M33.248.00

Handbohrapparate  
Bone Hand Drills  
Perforateurs à main  
Perforadores a mano  
Perforatori a mano



KIRSCHNER  
M33.250.00  
Compl.



M33.252.00



M33.260.00  
Compl.



M33.262.00



BUNNELL  
M33.270.00  
16 cm



RALK  
M33.280.00

Bohrapparate  
Bone Drills  
Perforateurs à os  
Perforadores para huesos  
Perforatori per ossa

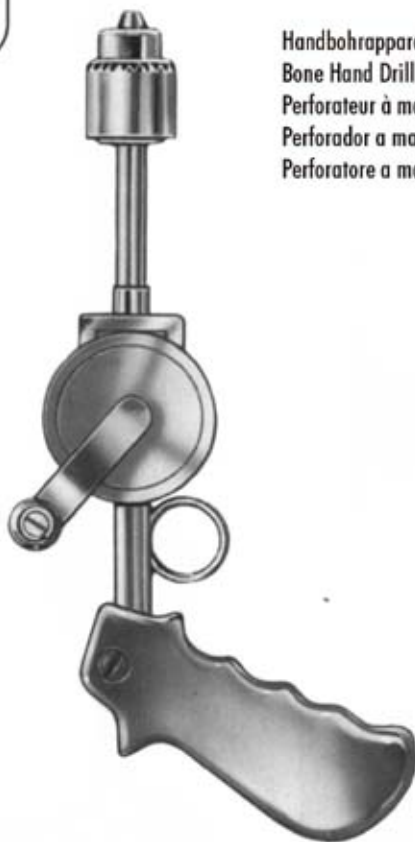

Handbohrapparat  
Bone Hand Drill  
Perforateur à main  
Perforador a mano  
Perforatore a mano

M33.290.00



M33.296.00



Elektrisch  
electrical  
électrique  
eléctrico  
elettrico

220 Volt M33.310.00  
110 M33.310.01



M33.312.00



Bohrer, Fräser, Trephinen  
 Burrs, Drills, Trephines  
 Mèches, fraises, trépan  
 Taladros, fresas, trefinas  
 Trapani, frese, trefine



1,0 mm		M33.352.10	M33.354.10
1,2		M33.352.12	
1,5		M33.352.15	M33.354.15
1,8		M33.352.18	
2,0	M33.350.20	M33.352.20	M33.354.15
2,2		M33.352.22	
2,5	M33.350.25	M33.352.25	M33.354.25
2,8		M33.352.28	M33.354.28
3,0	M33.350.30	M33.352.30	M33.354.30
3,2	M33.350.32	M33.352.32	M33.354.32
3,5	M33.350.50	M33.352.35	M33.354.35
4,0	M33.350.40	M33.352.40	M33.354.40
5,0	M33.350.50	M33.352.50	M33.354.50
6,0	M33.350.60		M33.354.60
7,0	M33.350.70		



mm	DOYEN	DOYEN	DOYEN	DOYEN	ALBEE	ALBEE	BORCHARDT	TOTI
4	M33.362.04	M33.364.04						
6	M33.362.06	M33.364.06						
7						M33.374.07		
8	M33.362.08	M33.364.08		M33.368.08	M33.372.08			M33.378.08
10	M33.362.10	M33.364.10		M33.368.10	M33.372.10			
12	M33.362.12	M33.364.12	M33.366.12		M33.370.2	M33.372.12		
13							M33.376.13	
14	M33.362.14	M33.364.14						
15				M33.370.15				
16	M33.362.16	M33.364.16						
25								M33.377.25

Zubehör zum Handmotor  
 Accessories for Bone Engine  
 Accessoires p. moteur à main  
 Accesorios para motor a mano  
 Accessori p. motore a mano



20 mm M33.380.20  
 25 mm M33.380.25  
 30 mm M33.380.30  
 35 mm M33.380.35  
 40 mm M33.380.40  
 45 mm M33.380.45  
 50 mm M33.380.50

M33.382.20  
 M33.382.25  
 M33.382.30  
 M33.382.35  
 M33.382.40  
 M33.382.45  
 M33.382.50



M33.383.20  
 M33.383.25  
 M33.383.30  
 M33.383.35  
 M33.383.40  
 M33.383.45  
 M33.383.50

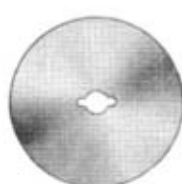

17 mm M33.386.17  
 22 mm M33.386.22  
 27 mm M33.386.27  
 32 mm M33.386.32  
 37 mm M33.386.37  
 42 mm M33.386.42  
 47 mm M33.386.47

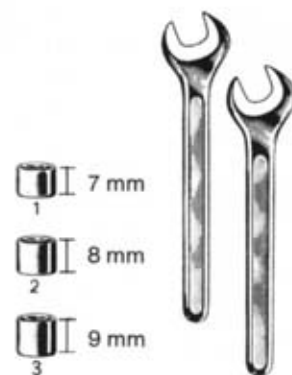

M33.387.00  
 compl.

M33.388.00  
 Satz. Set



M33.390.00  
 compl.



M33.392.14  
 14 cm



PERTHES  
 M33.395.21 21 cm

Bohrdrähte  
Wire Drills  
Broches de KIRSCHNER  
Taladros filiformes  
Fili KIRSCHNER



Trokarspitze  
Trocar tip  
Point trocart  
Punta en forma de trocar  
Punte a tre quarti

mm	L = 60 mm	L = 120 mm	L = 140 mm	L = 160 mm	L = 310 mm
1,0	M33.406.10	M33.412.10	M33.414.10	M33.416.10	M33.431.10
1,2	M33.406.12	M33.412.12	M33.414.12	M33.416.12	M33.431.12
1,4	M33.406.14	M33.412.14	M33.414.14	M33.416.14	M33.431.14
1,5	M33.406.15	M33.412.15	M33.414.15	M33.416.15	M33.431.15
1,6	M33.406.16	M33.412.16	M33.414.16	M33.416.16	M33.431.16
1,8	M33.406.18	M33.412.18	M33.414.18	M33.416.18	M33.431.18
2,0	M33.406.20	M33.412.20	M33.414.20	M33.416.20	M33.431.20
2,2	M33.406.22	M33.412.22	M33.414.22	M33.416.22	M33.431.22
2,5				M33.416.25	M33.431.25

KIRSCHNER  
M33.406.10-M33.431.25



Lanzenspitze  
Lancet tip  
Pointe lanceolaire  
Punta lanceolar  
Punte lanceolari

KIRSCHNER  
M33.432.10-M32.432.25



STEINMANN Nägel  
STEINMANN Pins  
STEINMANN clous à os  
STEINMANN clavos p. Huesos  
STEINMANN chiodi per ossa

L cm	
13	M33.490.13
14	M33.490.14
15	M33.490.15
16	M33.490.16
18	M33.490.18
20	M33.490.20
21	M33.490.21

STEINMANN  
M32.490.13-M33.490.21



Extensionsbügel  
 Extension Bows  
 Etriers à extension  
 Estribos para extensión  
 Archi per estensione

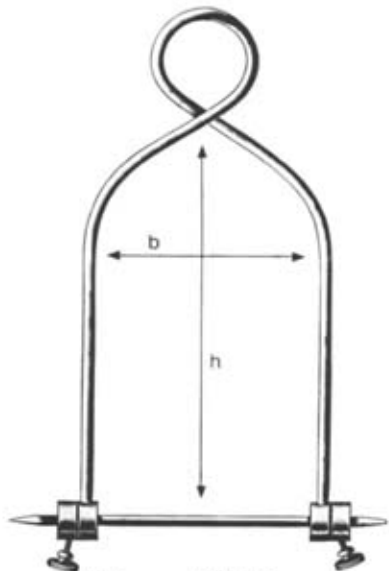

H x b cm	BOEHLER
16 x 9	M33.502.16
16 x 11	M33.502.21

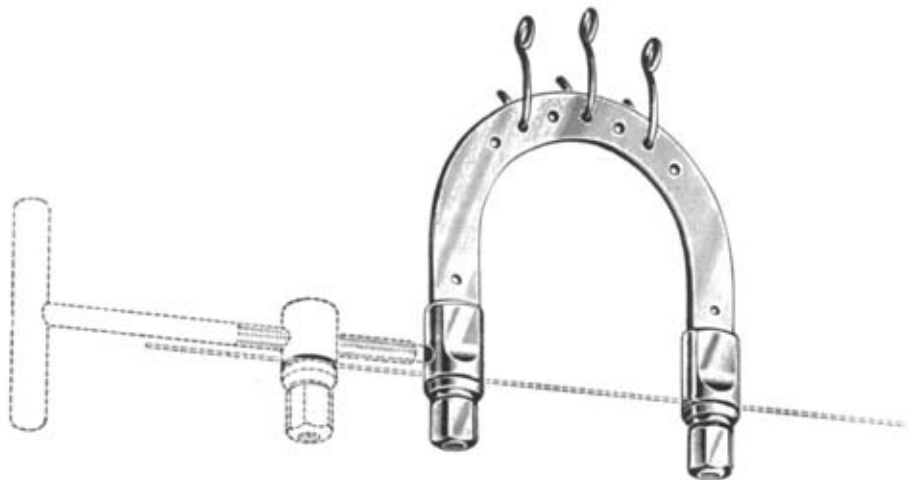

h x b cm	KIIRSCHNER
9,5 x 7,0	M33.512.09
10,5 x 10,5	M33.512.10
12,0 x 12,0	M33.512.12
15,5 x 15,5	M33.512.15
20,0 x 15,5	M33.512.20



h x b cm	
18 x 10	M33.514.18
27 x 16	M33.514.27



M33.515.01



M33.515.02



KIRSCHNER U.S.  
 M33.518.01  
 klein . Small . Petit  
 pequeno . Piccolo  
 M33.518.02  
 groß . Large size  
 grand . Grande



M33.519.01



M33.519.02

Knochendraht und -Instrumente  
Bone Wire and Instruments  
Fil à os et instruments  
Hilo p. huesos e instrumentos  
Filo per ossa e strumenti



mm Ø	
0,2	M33.530.02
0,3	M33.530.03
0,4	M33.530.04
0,5	M33.530.05
0,6	M33.530.06
0,7	M33.530.07
0,8	M33.530.08
0,9	M33.530.09
1,0	M33.530.10
1,1	M33.530.11
1,2	M33.530.12
1,5	M33.530.15



LOUTE  
M33.531.21  
21 cm



M33.532.17  
17 cm

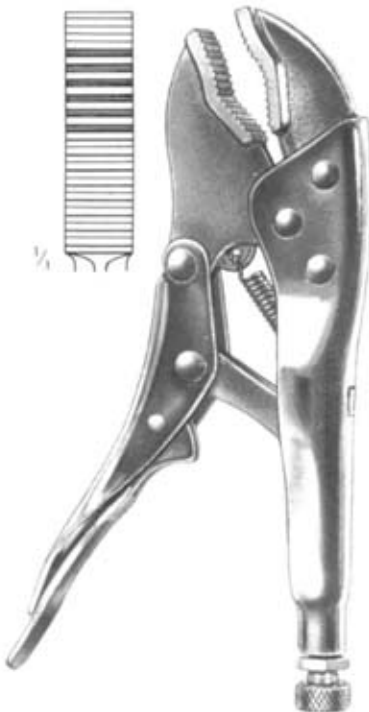

Grip  
M33.533.18



M33.534.15  
15 cm



M33.536.14  
14 cm

Knochenchirurgie  
 Bone Surgery  
 Chirurgie osseuse  
 Cirugía ósea  
 Chirurgia ossea



M33.540.16  
 16 cm



M33.542.15  
 15 cm



M33.545.22  
 22 cm



Mm Ø  
 2,4 M33.560.24  
 3,2 M33.560.32  
 4,8 M33.560.48  
 6,4 M33.560.64



M33.562.24  
 f./p. Ø 1,4 mm



M33.562.32  
 3,2 mm



M33.562.48  
 4,8 mm



M33.562.64  
 6,4 mm

Knochen Nagelung  
 Bone Nailing  
 Enclouage des os  
 Enclavamiento de huesos  
 Inchiodamento di ossa

mm	L = 35 mm	L = 46 cm	L = 60 cm
2,5	M33.581.35	M33.681.46	
3,0	M33.582.35	M33.582.46	
3,5	M33.583.35	M33.583.46	M33.583.60
4,0	M33.584.35	M33.584.46	M33.584.60
5,0	M33.485.35	M33.585.46	M33.585.60



KUENTSCHER  
 M33.571.26  
 26 cm



KUENTSCHER  
 M33.573.35  
 35 cm



M33.581.35  
 M33.585.60



KUENTSCHER  
 M33.586.21  
 21 cm



KUENTSCHER  
 M33.588.21  
 21 cm



1/3



1/3



M33.590.01



M33.590.02



01

KUENTSCHER  
 M33.690.00  
 63 cm



cm	
29	M33.596.29
37	M33.696.37
42	M33.596.42
49	M33.596.49



M33.598.30

Instrumente zur Osteosynthese  
 Osteosynthesis Instruments  
 Instruments p. ostéosynthèse  
 Instrumentos p. osteosíntesis  
 Strumenti per osteosintesi



LLOYD  
 M33.602.20  
 20 cm



LANE  
 m33.620.25  
 25 cm



WILLIAMS  
 M33.624.24  
 24 cm



mm  
 2,5 M33.628.25  
 3,5 M33.628.35



LANE  
 M33.632.25  
 25



LANE  
 M33.635.18  
 18 cm



LANE  
 M33.637.23  
 23 cm



LANE  
 M33.639.22  
 22 cm



LANE  
 M33.640.18  
 18 cm

Instrumentarium zum Einbringen von Hohlrauben  
 Instrument Set for Cannulated Screws  
 Instrumentation pour l'application des vis à perforation longitudinale  
 Instrumental para la aplicación de tornillos de perforación longitudinal  
 Strumentario per viti cannulate

Instrumente zur Osteosynthese  
 Osteosynthesis Instruments  
 Instruments p. ostéosynthèse  
 Instrumentos p. osteosíntesis  
 Strumenti per osteosintesi



mm	
4,5	M33.802.45
7,0	M33.802.70

M33.810.05  
5 mm



mm	
4,5	M33.812.45
7,0	M33.812.70



mm	
2,5	M33.816.25
3,5	M33.816.35
5,0	M33.16.50



M33.820.00

Hohlrauben siehe S.152  
 Cannulated Screws see page 152  
 Vis à perforation longitudinale, voir p. 152  
 Tornillos de perforación longitudinal, véanse pág. 152  
 Viti cannulate, vedere pag. 152

Knochenchirurgie  
 Bone Surgery  
 Chirurgie osseuse  
 Cirugía ósea  
 Chirurgia ossea

Marknägel, rund, mit Haken  
 Intramedullary Pins, Round, with Hook  
 Broches à crochets centromédullaires, rondes  
 Clavos intramedulares con ganchos, redondos  
 Chiodi a gancio centromidollari, rotondi

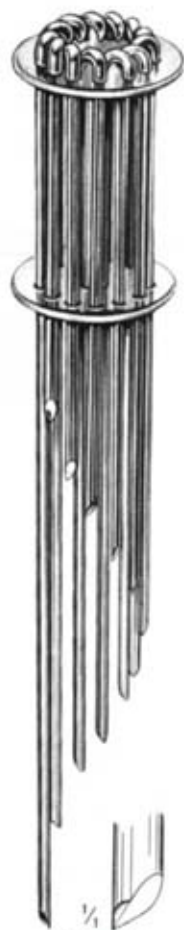

mm	Set compl.
2,4	M36.002.00
3,2	M36.003.00
4,8	M36.004.00
6,4	M36.006.00

L = mm	2,4 mm	3,2 mm	4,8 mm	6,4 mm
25	M36.002.25			
30	M36.002.30			
40	M 36.002.40			
45	M 36.002.45			
50	M 36.002.50			
60	M 36.002.60			
65	M 36.002.65			
70	M 36.002.70			
75	M 36.002.75			
80	M 36.002.80			
85	M 36.002.85			
90	M 36.002.90			
95	M 36.002.95			
100	M 36.002.99			
120		M36.00310.		
130		M36.003.12		
140		M36.003.13		
150		M36.003.14		
160		M36.003.15		
180		M36.003.16		
190		M36.003.17		
200		M36.003.18	M36.004.20	
210		M36.003.19		
220			M36.004.22	
230		M36.003.21		
240		M36.003.24	M36.003.24	
250		M36.003.25		
260			M36.004.26	
280			M36.004.28	M36.006.28
290				M36.006.29
300			M36.004.30	
320			M36.004.32	M36.006.32
340			M36.004.34	M36.006.34
360			M36.004.36	M36.006.36
370				M36.006.37
390				M36.006.39
410				M36.006.41
430				M36.006.43

Knochenchirurgie  
 Bone Surgery  
 Chirurgie osseuse  
 Cirugía ósea  
 Chirurgia ossea



L = cm	6 mm	7 mm	8 mm	9 mm	10 mm	11 mm	12 mm	13 mm	14 mm	15 mm	16 mm
14	M36.016.14	M36.017.14									
16	M36.016.16	M36.017.16									
18	M36.016.18	M36.017.18									
20	M36.016.20	M36.017.20									
22	M36.016.22	M36.017.22									
24	M36.016.24	M36.017.24									
26	M36.106.26	M36.017.26									
28	M36.016.28	M36.017.28	M36.018.28								
30	M36.016.30	M36.017.30	M36.018.30	M36.019.30	M36.020.30						
32	M36.016.32	M36.017.32	M36.018.32	M36.019.32	M36.020.32						
34	M36.016.34	M36.017.34	M36.018.34	M36.019.34	M36.020.34						
36	M36.016.36	M36.017.36	M36.018.36	M36.019.36	M36.020.36	M36.021.36	M36.022.36	M36.023.36	M36.024.36		
37					M36.020.35	M36.021.37	M36.022.37	M36.023.37			
38		M36.017.38	M36.018.38	M36.019.38	M36.020.38	M36.021.38	M36.022.38	M36.023.38	M36.024.38	M36.025.38	M36.026.38
39					M36.020.39	M36.021.39	M36.022.29	M36.023.39	M36.024.39		
40		M36.017.40	M36.018.40	M36.019.40	M36.020.40	M36.021.40	M36.022.40	M36.023.40	M36.024.40	M36.025.40	M36.026.40
41					M36.020.41	M36.021.41	M36.022.41	M36.023.41			
42		M36.016.42	M36.018.42	M36.019.42	M36.020.42	M36.021.42	M36.022.42	M36.023.42	M36.024.42	M36.025.43	M36.026.42
43						M36.021.43		M36.023.43			
44		M36.016.44	M36.018.44	M36.019.44	M36.020.44	M36.021.44	M36.022.44	M36.023.44	M36.024.44	M36.025.44	M36.026.44
45											
46		M36.016.46	M36.018.46	M36.019.46	M36.020.46	M36.021.46	M36.022.46	M36.023.46	M36.024.46	M36.025.46	M36.026.46
48		M36.016.48	M36.018.48	M36.019.48	M36.020.48	M36.021.48	M36.022.48	M36.023.48	M36.024.48	M36.025.48	M36.026.48
50		M36.016.50	M36.018.50	M36.019.50	M36.020.52	M36.021.52	M36.022.52	M36.023.52	M36.024.50		
52							M36.022.52				



Knochenchirurgie  
Bone Surgery  
Chirurgie osseuse  
Cirugía ósea  
Chirurgia ossea

KÜNTSCHER- Nägel für Unterschenkel und Oberarm  
KÜNTSCHER Intramedullary nails for Tibia and Humerus  
KÜNTSCHER clous centromédullaires pour tibia et humérus  
KÜNTSCHER clavos centromedulares para tibia y húmero  
KÜNTSCHER chiodi centromidollari per tibia e emero



KÜNTSCHER  
M36.036.18- M36.044.40

L = cm	6 mm	7 mm	8 mm	9 mm	10 mm	11 mm	12 mm	13 mm	14 mm
18	M36.036.18	M36.037.18	M36.038.18	M36.039.18	M36.040.18	M36.041.18			
19		M36.037.19	M36.038.19	M36.039.19	M36.040.19	M36.041.19			
20	M36.036.20	M36.037.20	M36.038.20	M36.039.20	M36.040.20	M36.041.20			
21		M36.037.21	M36.038.21	M36.039.21	M36.040.21	M36.041.21			
22	M36.036.22	M36.037.22	M36.038.22	M36.039.22	M36.040.22	M36.041.22			
23		M36.037.23	M36.038.23	M36.039.23	M36.040.23	M36.041.23			
24	M36.036.24	M36.037.24	M36.038.24	M36.039.24	M36.040.24	M36.041.24			
25		M36.037.25	M36.038.25	M36.039.25	M36.040.25	M36.041.25			
26	M36.036.26	M36.037.26	M36.038.26	M36.039.26	M36.040.26	M36.041.26	M36.042.26		
27		M36.037.27	M36.038.27	M36.039.27	M36.040.27	M36.041.27	M36.042.27		
28	M36.036.28	M36.037.28	M36.038.28	M36.039.28	M36.040.28	M36.041.28	M36.042.28		
29		M36.037.29	M36.038.29	M36.039.29	M36.040.29	M36.041.29	M36.042.29	M36.043.29	M36.044.29
30	M36.036.30	M36.037.30	M36.038.30	M36.039.30	M36.041.30	M36.041.30	M36.042.30	M36.043.30	M36.044.30
31		M36.037.31	M36.038.31	M36.039.31	M36.040.31	M36.041.31	M36.042.31	M36.043.31	M36.044.31
32		M36.037.32	M36.038.32	M36.039.32	M36.040.32	M36.041.32	M36.042.32	M36.043.32	M36.044.32
33		M36.037.33	M36.038.33	M36.039.33	M36.040.33	M36.041.33	M36.042.33	M36.043.33	M36.044.33
34		M36.037.34	M36.038.34	M36.039.34	M36.040.34	M36.041.34	M36.042.34	M36.043.34	M36.044.34
35		M36.037.35	M36.038.35	M36.039.35	M36.040.35	M36.041.35	M36.042.35	M36.043.35	M36.044.35
36		M36.037.36	M36.038.36	M36.039.36	M36.040.36	M36.041.36	M36.042.36	M36.043.36	M36.044.36
37		M36.037.37	M36.038.37	M36.039.37	M36.040.37	M36.041.37	M36.042.37	M36.043.37	M36.044.37
38		M36.037.38	M36.038.38	M36.039.38	M36.040.38	M36.041.38	M36.042.38	M36.043.38	M36.044.38
39				M36.039.39	M36.040.39	M36.041.39	M36.042.39	M36.043.39	M36.044.39
40			M36.038.40	M36.039.40	M36.040.40	M36.041.40	M36.042.40	M36.043.40	M36.044.40

Knochenchirurgie  
 Bone Surgery  
 Chirurgie osseuse  
 Cirugía ósea  
 Chirurgia ossea

Schenkelhalsnägel und Zubehör  
 Hip Nails and Accessories  
 Clous pour le col du fémur et accessoires  
 Clavos para el cuello del fémur y accesorios  
 Chiodi per il collo del femore e accessori



L = mm	SMITH-PETERSEN	BÖHLER
60	M36.050.60	
65	M36.050.65	
70	M36.050.70	
75	M36.050.75	
80	M36.050.80	M36.060.85
85	M36.050.85	M36.060.80
90	M36.050.90	M36.060.90
95	M36.050.95	M36.060.95
100	M36.051.00	M36.061.00
105	M36.051.05	M36.061.05
110	M36.051.10	M36.061.10
115	M36.051.15	M36.061.15
120	M36.051.20	M36.061.20
125	M36.051.25	
130	M36.051.30	M36.061.30
135	M36.051.35	
140	M36.051.40	M36.061.40
145	M36.051.45	
150	M36.051.50	
160	M36.051.60	M36.061.60
170	M36.051.70	

	Loch perf. fori		Loch perf, fori
McLAUGHLIN		SMITH-PETERSEN	
M36.062.03	3	M36.063.03	3
M36.062.05	5	M36.063.04	4
M36.062.07	7	M36.063.05	5
M36.062.12	12	M36.063.03	6
		M36.063	7

Knochenchirurgie  
Bone Surgery  
Chirurgie osseuse  
Cirugía ósea  
Chirurgia ossea

Schenkelhals - Nägel . Hip Nails  
Clous pour le col du fémur .  
Clavos para el cuello del fémur  
fracturado . Chiodi per il collo  
del femore

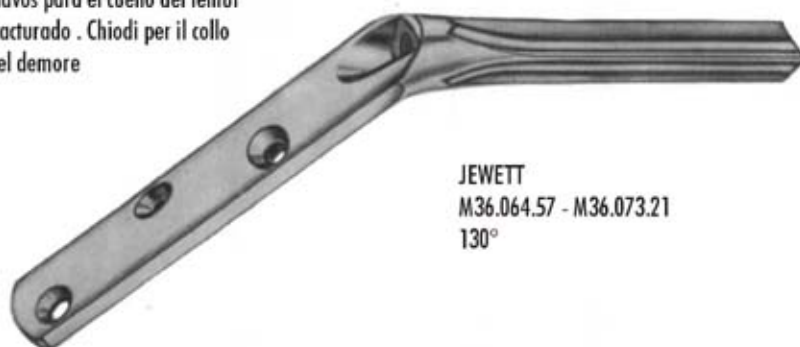

JEWETT  
M36.064.57 - M36.073.21  
130°

	L = 57 mm	L = 63 mm	L = 70 mm	L = 76 mm	L = 82 mm	L = 89 mm	L = 95 mm	L = 102 mm	L = 108 mm	L = 114 mm	L = 121 mm
A*	M36.064.57	M36.064.63	M36.064.70	M36.064.76	M36.064.82	M36.064.89	M36.064.95	M36.065.02	M36.065.08	M36.065.14	M36.065.21
B*	M36.066.57	M36.066.63	M36.066.70	M36.066.76	M36.066.82	M36.066.89	M36.066.95	M36.067.02	M36.067.08	M36.067.14	M36.067.21
C*	M36.068.57	M36.068.63	M36.068.70	M36.068.76	M36.068.82	M36.068.89	M36.068.95	M36.069.02	M36.069.08	M36.069.14	M36.069.21
D*	M36.070.57	M36.070.63	M36.070.70	M36.070.76	M36.070.82	M36.070.89	M36.070.95	M36.071.02	M36.071.08	M36.071.14	M36.071.21
E*	M36.072.57	M36.072.63	M36.072.70	M36.072.76	M36.072.82	M36.072.89	M36.072.95	M36.073.02	M36.073.08	M36.073.14	M36.073.21

\*A = 3 Loch, Plattenlänge 90 mm

3 hole, plate length 90 mm  
3 trous, longueur de la plaque 90 mm  
3 agujeros, largo de la placa 90 mm  
3 ton, lunghezza della placca 90 mm

\*B = 5 Loch, Plattenlänge 135 mm

5 hole, plate length 135 mm  
5 trous, longueur de la plaque 135 mm  
5 agujeros, largo de la placa 135 mm  
5 fon, lunghezza della placca 135 mm

\*C = 7 Loch, Plattenlänge 165 mm

7 hole, plate length 165 mm  
7 trous, longueur de la plaque 165 mm  
7 agujeros, largo de la placa 165 mm  
7 ton, lunghezza della placca 165 mm

\*D = 10 Loch, Plattenlänge 220 mm

10 hole, plate length 220 mm  
10 trous, longueur de la plaque 220 mm  
10 agujeros, largo de la placa 220 mm  
10 fon, lunghezza della placca 220 mm

\*E = 12 Loch, Plattenlänge 260 mm

12 hole, plate length 260 mm  
12 trous, longueur de la plaque 260 mm  
12 agujeros, largo de la placa 260 mm  
12 fon, lunghezza della placca 260 mm

Knochenchirurgie  
Bone Surgery  
Chirurgie osseuse  
Cirugía ósea  
Chirurgia ossea

Dynamische Hüft-Schrauben und -Platten ·  
Dynamic Hip Screws and Plates · Vis et  
plaques dynamiques pour le col du fémur ·  
Tornillos y placas dinámicos para el  
cuello del fémur · Vite e placche dinamiche  
per il collo del femore



M36.080.02-M36.087.12

Rundloch . Round Holes . Tous ronds . Agujeros redondos . Fori rotondi

	2*	4*	5*	6*	8*	10*	12*	14*	16*
135°	M36.080.02	M36.081.04	M36.080.05	M36.080.06	M36.080.08	M36.080.10	M36.080.12	M36.08.14	M36.080.16
140°		M36.081.04	M36.081.05	M36.081.06					
145°		M36.082.04	M36.082.05	M36.082.06					
150°	M36.083.02	M36.083.04	M36.083.05	M36.083.06	M36.083.08	M36.083.10	M36.083.12		

Gleitloch . Sliding Holes . Troux à glissement - Agujeros deslizantes . Fori a scivolamento

	2*	4*	5*	6*	8*	10*	12*	14*	16*
135°	M36.084.02	M36.084.04	M36.084.05	M36.084.06	M36.084.08	M36.084.10	M36.084.12	M36.04.14	M36.04.16
140°		M36.085.04	M36.085.05	M36.085.06					
145°		M36.086.04	M36.086.05	M36.086.06					
150°	M36.083.02	M36.087.04	M36.087.05	M36.087.06	M36.087.08	M36.087.10	M36.087.12		

\* Anzahl Löcher . Number of holes . Nombre de trous . Número de agujeros . Numero di fori



M36.088.50-M36.089.45



M36.09.36  
36 cm

22 mm

L = mm

50	M36.088.50
55	M36.088.55
60	M36.088.60
65	M36.088.65
70	M36.088.70
75	M36.088.75
80	M36.088.80
85	M36.088.85
90	M36.088.90
95	M36.088.95
100	M36.088.00
105	M36.088.05
110	M36.088.10
115	M36.088.15
120	M36.088.20
125	M36.088.25
130	M36.088.30
135	M36.088.35
140	M36.088.40
145	M36.088.45

Knochenchirurgie  
Bone Surgery  
Chirurgie osseuse  
Cirugía ósea  
Chirurgia ossea

Hohlschrauben . Cannulated Screws  
Via à perforation longitudinale.  
Tornillos de perforacion longitudinal  
Viti cannulate

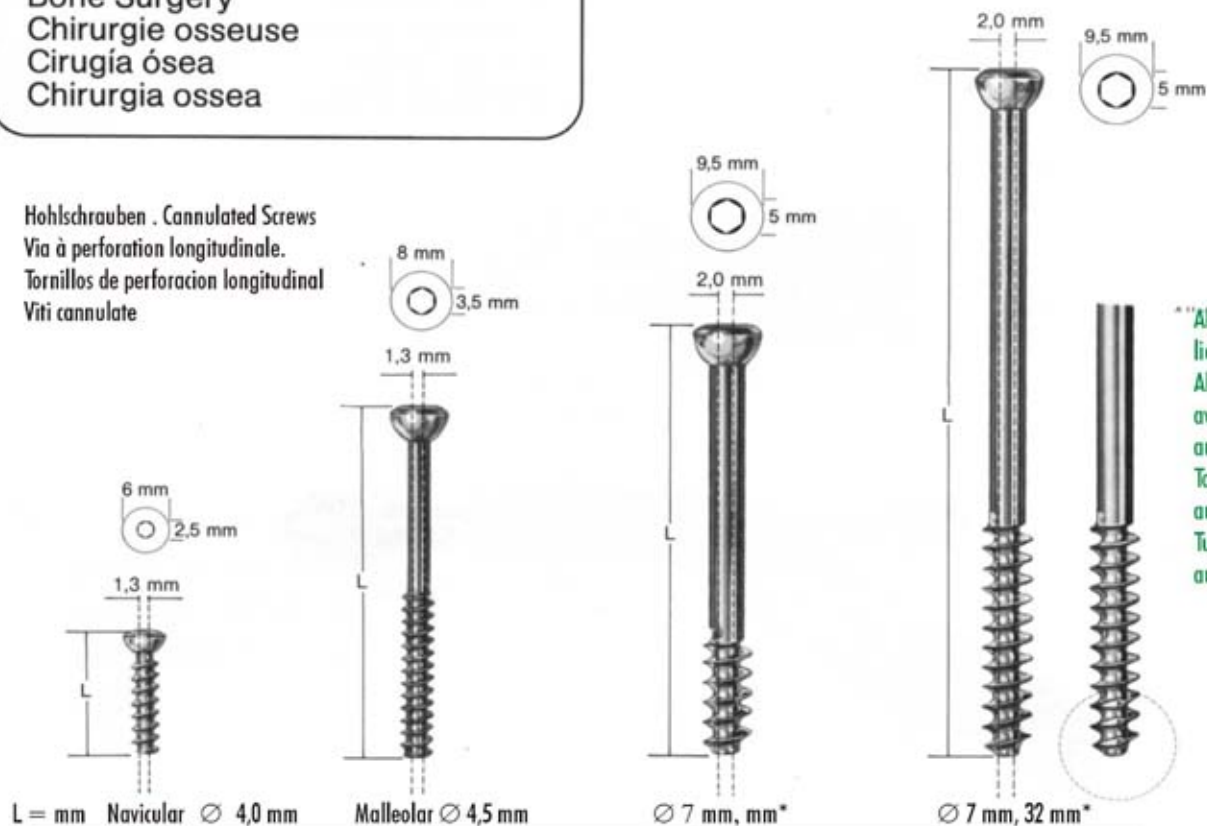

\*\*\*Alle Modelle auch selbstschneidend  
lieferbar.  
All types also  
available selftaping Tous les modèles  
aussi disponible autoaraudants.  
Todos los modelos también disponibles  
autoroscantes.  
Tutti i modelli anche disponibili  
autofilettanti.

L = mm	Navicular Ø 4,0 mm	Malleolar Ø 4,5 mm	Ø 7 mm, mm*	Ø 7 mm, 32 mm*
10	M36.107.10			
12	M36.107.10			
14	M36.107.10			
16	M36.107.10			
18	M36.107.10			
20	M36.107.10			
22	M36.107.10			
24	M36.107.10			
25		M36.115.25	M36.116.25	
26	M36.107.10			
28	M36.107.10			
30	M36.107.10	M36.115.30	M36.116.30	
35		M36.115.35	M36.116.35	M36.118.35
40		M36.115.40	M36.116.40	M36.118.40
45		M36.115.45	M36.116.45	M36.118.45
50		M36.115.50	M36.116.50	M36.118.50
55		M36.115.55	M36.116.55	M36.118.55
60			M36.116.60	M36.118.60
65			M36.116.65	M36.118.65
70			M36.116.70	M36.118.70
75			M36.116.75	M36.118.75
80			M36.116.80	M36.118.80
85			M36.116.85	M36.118.85
90			M36.116.90	M36.118.90
95			M36.116.95	M36.118.95
100			M36.116.00	M36.118.00
105			M36.116.05	M36.118.05
110			M36.116.10	M36.118.10
115			M36.116.15	M36.118.15
120			M36.116.20	M36.118.20

\*Gewindelänge  
\*Length of thread  
\*Longueur du filet  
\*Largo de la rosca  
\*Lunghezza del filetto

Ø mm Unterlegscheibe  
13 M36.130.13 Washer  
16 M36.120.16 Rondelle  
19 M36.120.19 Arandela  
Rondella

M36.120.13-M36.120.19

Osteosynthese  
Osteosynthesis  
Ostéosynthèse  
Osteosíntesis  
Osteosintesi

Knochenschrauben ·  
Bone Screws · Vis à os ·  
Tornillos para huesos ·  
Viti per ossa

## Corticalis

## Spongiosa Cancellous

mini

klein  
small  
petites  
pequeños  
piccole

klein  
small  
petites  
pequeños  
piccole

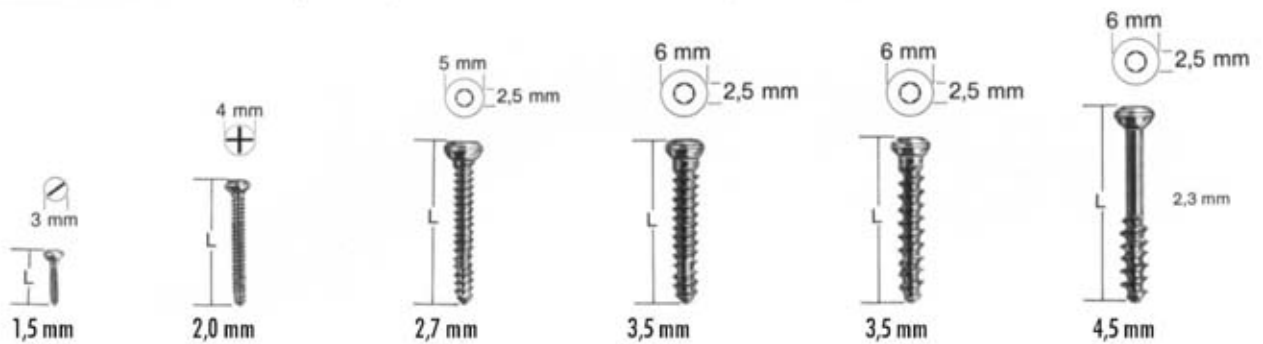

L = mm	M36.200.06	DIN 58812 ISO 5835/I M36.201.06	DIN 58812 ISO 5835/I M36.202.06	DIN 58812 ISO 5835/I	M36.206.10	DIN 58812 ISO 5835/I M36.207.10
6	M36.200.06					
7	M36.200.07					
8	M36.200.08	M36.201.08	M36.202.08			
9	M36.200.09					
10	M36.200.00	M36.201.00	M36.202.00	M36.204.10	M36.206.10	M36.207.10
11	M36.200.00					
12	M36.200.12	M36.201.12	M36.202.12	M36.204.12	M36.206.12	M36.207.12
14	M36.200.14	M36.201.14	M36.202.14	M36.204.14	M36.206.14	M36.207.14
16	M36.200.16	M36.201.16	M36.202.16	M36.204.16	M36.206.16	M36.207.16
18		M36.201.18	M36.202.18	M36.204.18	M36.206.18	M36.207.18
20		M36.201.20	M36.202.20	M36.204.20	M36.206.20	M36.207.20
22			M36.202.22	M36.204.22	M36.206.22	M36.207.22
24			M36.202.24	M36.204.24	M36.206.24	M36.207.24
26			M36.202.26	M36.204.26	M36.206.26	M36.207.26
28			M36.202.28	M36.204.28	M36.206.28	M36.207.28
30						M36.207.30
32			M36.202.32	M36.204.32	M36.206.32	
35						M36.207.35
36				M36.204.36	M36.206.36	
40				M36.204.40	M36.206.40	M36.207.40
45				M36.204.45	M36.206.45	M36.207.45
50				M36.204.50	M36.206.50	M36.207.50
55					M36.206.55	
60					M36.206.60	

Unterlegscheibe  
Washer  
Rondelle  
Arandela  
Rondella

7 mm

M36.209.97

Osteosynthese  
Osteosynthesis  
Ostéosynthèse  
Osteosíntesis  
Osteosintesi

Große Schrauben  
Large Screws  
Vis grandes  
Toillos grandes  
Viti grandi

Corticalis- und Malleolarschrauben  
Corticalis and Malleolr Screws  
Vis corticales et malleolaires  
Tornillos corticales y maleolares  
Viti corticali e malleolari



L = mm	DIN 58812 ISO 5835/1	DIN 58814 ISO 5835/1
14	M36.214.14	
16	M36.214.16	
18	M36.214.18	
20	M36.214.20	
22	M36.214.22	
24	M36.214.24	
25		M36.215.25
26	M36.214.26	
28	M36.214.28	
30	M36.214.30	M36.215.30
32	M36.214.32	
34	M36.214.34	
35		M36.215.35
36	M36.214.36	
38	M36.214.38	
40	M36.214.40	M36.215.40
42	M36.214.42	
44	M36.214.44	
45		M36.215.45
46	M36.214.46	
48	M36.214.48	
50		M36.215.50
52	M36.214.52	
54		
55		M36.215.55
56	M36.214.56	
60	M36.214.60	M36.215.60
64	M36.214.64	
65		M36.215.65
70	M36.214.70	

Mutter 11 mm  
Nut  
Ecrou  
Tuerca  
Dado M36.219.96

Große Schrauben  
Large Screws  
Vis grandes  
Tornillos grandes  
Viti grandi

Osteosynthese  
Osteosynthesis  
Ostéosynthèse  
Osteosintesis  
Osteosintesi

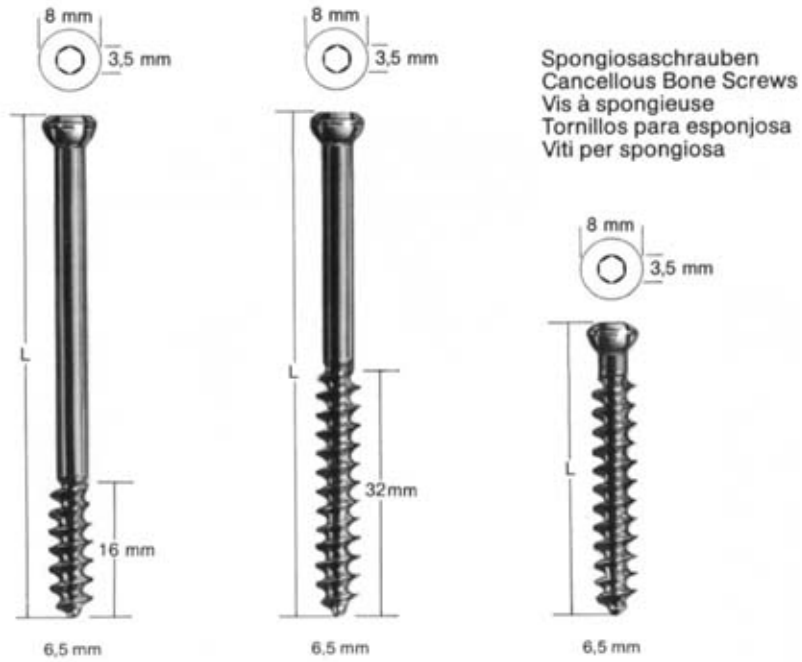

L = mm	DIN 58815 ISO 5835/1	DIN 58815 ISO 5835/1	
25			36.218.25
30	36.216.30		36.218.30
35	36.216.35		36.218.35
40	36.216.40		36.218.40
45	36.216.45	36.217.45	36.218.45
50	36.216.50	36.217.50	36.218.50
55	36.216.55	36.217.55	36.218.55
60	36.216.60	36.217.60	36.218.60
65	36.216.65	36.217.65	36.218.65
70	36.216.70	36.217.70	36.218.70
75	36.216.75	36.217.75	36.218.75
80	36.216.80	36.217.80	36.218.80
85	36.216.85	36.217.85	36.218.85
90	36.216.90	36.217.90	36.218.90
95	36.216.95	36.217.95	36.218.95
100	36.216.00	36.217.00	36.218.00
105	36.216.05	36.217.05	36.218.05
110	36.216.10	36.217.10	36.218.10

Unterlegscheibe  
Washer  
Rondelle  
Arandela  
Rondella





Osteosynthese  
Osteosynthesis  
Ostéosynthèse  
Osteosíntesis  
Osteosintesi



Halbrohrplatten mit Rundlöchern  
Semi-tubular Plates with Round Holes  
Plaques semi-tubulaires à trous ronds  
Placas semitubulares con orificios redondos  
Placche semitubo



L = mm	Löcher . Holes . Trous	Orificios . Fori
39	2	M36.222.02
55	3	M36.222.03
71	4	M36.222.04
87	5	M36.222.05
103	6	M36.222.06
119	7	M36.222.07
135	8	M36.222.08
151	9	M36.222.09
167	10	M36.222.10
183	11	M36.222.11
199	12	M36.222.12

Osteosynthese  
Osteosynthesis  
Ostéosynthèse  
Osteosíntesis  
Osteosintesi



Schmale Platten  
Narrow Plates  
Plaques étroites  
Placas estrechas  
Placche strette



M36.223.02-M36.223.16



M36.224.02-M36.224.16

Rundloch  
Round Holes  
Trous ronds  
Orificios redondos  
Fori rotondi

Gleitloch  
Gliding Holes  
Trous à compression  
Orificios para compresión  
Fori da compressione

L = mm	Löcher . Holes . Trous Orificios . Fori	Roundloch . Round Holes . Trous round . Orificios redondos . Fori rot.	Gleitloch . Fliding Holes . Trous à compres. Orificios p. Compres. Fori da compres
39	2	M36.223.02	M36.334.02
55	3	M36.223.03	M36.334.03
71	4	M36.223.04	M36.334.04
87	5	M36.223.05	M36.334.05
103	6	M36.223.06	M36.334.06
119	7	M36.223.07	M36.334.07
135	8	M36.223.08	M36.334.08
151	9	M36.223.09	M36.334.09
167	10	M36.223.10	M36.334.10
183	11	M36.223.11	M36.334.11
199	12	M36.223.12	M36.334.12
215	13	M36.223.13	M36.334.13
231	14	M36.223.14	M36.334.14
247	15	M36.223.15	M36.334.15
263	16	M36.223.16	M36.334.16

Osteosynthese  
Osteosynthesis  
Ostéosynthèse  
Osteosíntesis  
Osteosintesi

Breite Platten  
Broad Plates  
Plaques larges  
Placas anchas  
Placche larghe

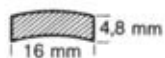

Kondylenplatten  
Condylar Plates  
Plaques condyloires  
Placas condilares  
Placche condilari

Osteosynthese  
Osteosynthesis  
Ostéosynthèse  
Osteosintesis  
Osteosintesi

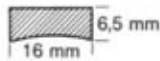

95°



M36.231.20-M36.231.26  
M36.237.20-M36.237.26

M36.231.50-M36.231.56  
M36.237.50-M36.237.56

M36.231.70-M36.231.76  
M36.237.70-M36.237.76

M36.231.90-M36.231.96  
M36.237.90-M36.237.967

Rundlöcher . Round Holes . Trous ronds . Orificios redondos . Fori rotondi

KL \ SL	92 mm	124 mm	156 mm	204 mm
50 mm	M36.231.20	M36.231.50	M36.231.70	M36.231.90
60 mm	M36.231.22	M36.231.52	M36.231.72	M36.231.92
70 mm	M36.231.24	M36.231.54	M36.231.74	M36.231.94
80 mm	M36.231.26	M36.231.56	M36.231.76	M36.231.96

Gleitlöcher . Gliding Holes . Trous à compression .  
Orificios para compresión . Fori da compressione

SL \ KL	92 mm	124 mm	156 mm	204 mm
50 mm	M36.237.20	M36.237.50	M36.237.70	M36.237.90
60 mm	M36.237.22	M36.237.52	M36.237.72	M36.237.92
70 mm	M36.237.24	M36.237.54	M36.237.74	M36.237.94
80 mm	M36.237.26	M36.237.56	M36.237.76	M36.237.96

Osteosynthese  
Osteosynthesis  
Ostéosynthèse  
Osteosintesis  
Osteosintesi

Winkelplatten  
Angular Plates  
Plaques angulaires  
Placas angulares  
Placche angolari

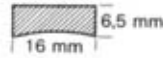

130°

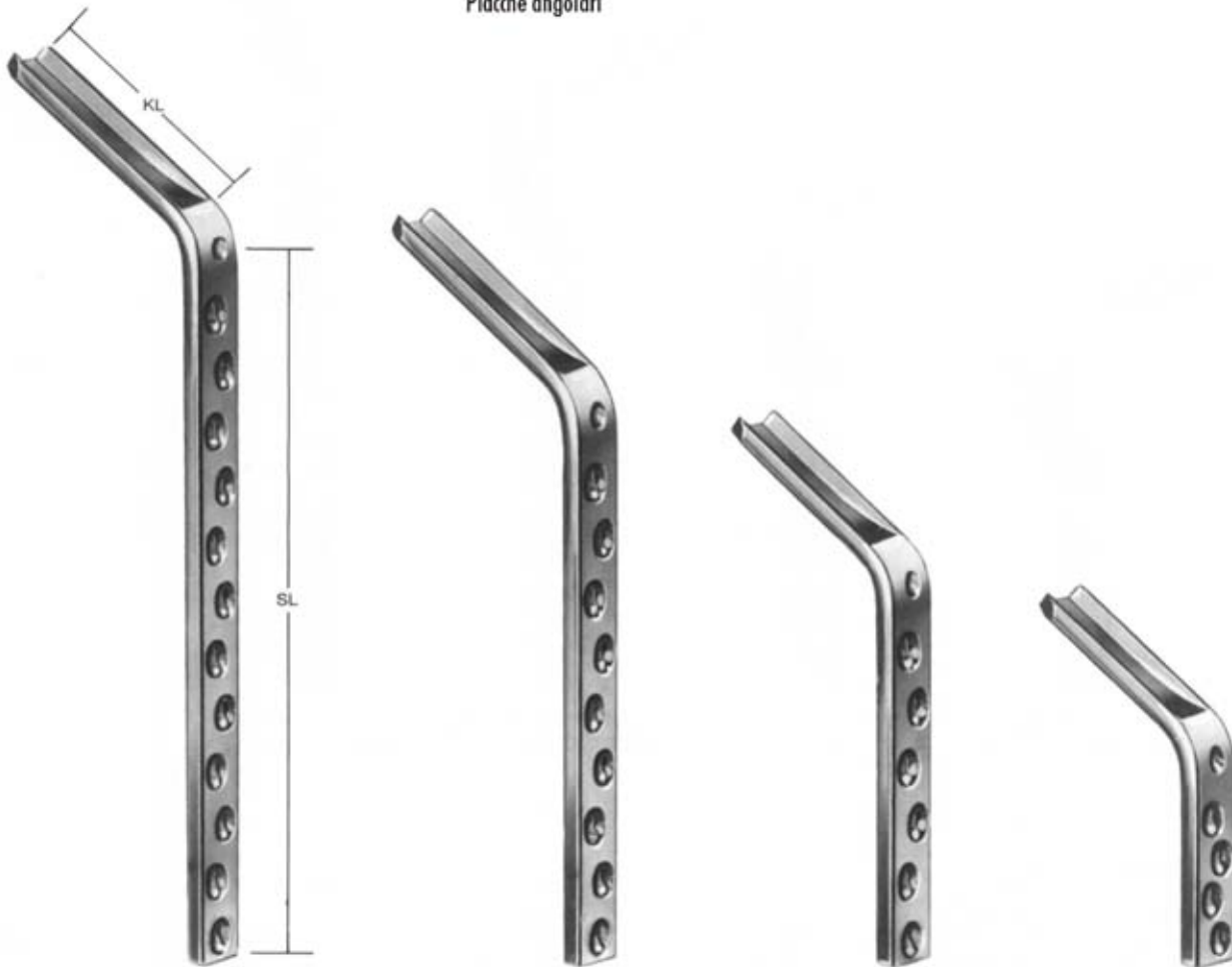

SL Rundloch . Rond Holes . Trous ronds .  
Orificios redondos . Fori rotondi

Gleitlöcher . Gliding Holes . Trous à compression  
Orificios para compresión . Fori da compressione

KL	60 mm	104 mm	152 mm	200 mm	60 mm	104 mm	152 mm	200 mm
50 mm	M36.233.36	M36.233.60			M36.238.36	M36.233.60		
60	M36.233.38	M36.233.62			M36.238.38	M36.238.62		
70	M36.233.36	M36.233.64	M36.233.94	M36.233.24	M36.238.44	M36.238.64	M36.238.94	M36.238.24
75	M36.233.45				M36.238.45			
80	M36.233.46	M36.238.36	M36.233.96	M36.238.26	M36.238.46	M36.238.66	M36.238.96	M36.238.26
85	M36.233.47				M36.238.47			
90	M36.233.48	M36.238.68	M36.233.98	M36.238.28	M36.238.60	M36.238.48	M36.238.98	M36.238.28
95	M36.233.49				M36.238.49			
100	M36.233.40				M36.238.40			
105	M36.233.41				M36.238.41			
110	M36.233.42				M36.238.42			

Osteosynthese  
Osteosynthesis  
Ostéosynthèse  
Osteosintesis  
Osteosintesi

Knochenplatten mit Rundlöchern  
Bone plattes with Round Holes  
Plawues à os à trous ronds  
Placas p. Huesos con orificios redondos  
Placche per ossa con fori rotondi

Drittelrohrplatten  
One Third-Tubular Plates  
Pasques d'un tiers de tube  
Placas de un tercio de tubo  
Placche di un terzo di tubo

Viertelrohrplatten  
One Quater-Tubular Plates  
Plaques d'unquart de tube  
Placas de un cuarto de tubo  
Placche di und quarto di tubo



M36.241.02-M36.241.08

L = mm	Loch . Holes	
	Trous . Orificios . Fori	
25	2	M36.241.02
37	3	M36.241.03
49	4	M36.241.04
61	5	M36.241.05
73	6	M36.241.06
85	7	M36.241.07
97	8	M36.241.08

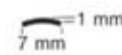

M36.241.13-M36.242.18

L = mm	Loch . Holes	
	Trous . Orificios . Fori	
23	3	M36.242.13
31	4	M36.242.14
39	5	M36.242.15
47	6	M36.242.16
55	7	M36.242.17
63	8	M36.242.18

Osteosynthese  
Osteosynthesis  
Ostéosynthèse  
Osteosíntesis  
Osteosintesi

Mini-Fragment-Platten  
mini-Fragmentplates  
Plaques à fragments mini  
Placas para fragmentos mini  
Placche per frammenti mini

Finger-Platten  
Finger Plates  
Plaques à doigts  
Placas para dedos  
Placche per dita

L-förmig, links  
L-shaped, left side  
forme L, à gauche  
forma L, a la izquierda  
forma L, a sinistra



L-förmig, rechts  
L-shaped, right side  
forme L, à droite  
forma L, a la derecha  
forma L, a destra

Schräg links  
left side oblique  
à gauche oblique  
a la izquierda oblicua  
a sinistra obliqua



Schräg rechts  
right side oblique  
à droite oblique  
a la derecha oblicua  
a destra obliqua

M36.242.33

M36.242.32

T-förmig  
T-shaped  
forme T  
forma T



M36.242.41

Gerade Mini-Platten  
Straight Mini Plates  
Mini-plaques droites  
Mini-placas rectas  
Mini-placche rette



L = mm	Löcher . Holes . Trous	Orificios . Fori
17	3	M36.243.13
23	4	M36.243.14
29	5	M36.243.15
35	6	M36.243.16

Osteosynthese  
Osteosynthesis  
Ostéosynthèse  
Osteosintesis  
Osteosintesi

Finger - Plättchen  
Finger Plates  
Plaques à doigts  
Placas para dedos  
Placche per dita

L-förmig, links  
L-shaped, left side  
forme L, à gauche  
forma L, a la izquierda  
forma L, a sinistra



L-förmig, rechts  
L-shaped, right side  
forme L, à droite  
forma L, a la derecha  
forma L, a destra

schräg links  
left side oblique  
à gauche oblique  
a la izquierda oblicua  
a sinistra obliqua



schräg rechts  
right side oblique  
à droite oblique  
a la derecha oblicua  
a destra obliqua

T-förmig  
T-shaped  
forme T  
forma T  
forma T



M36.244.02 - M36.244.22

Kleinfragmentplatten  
Small Fragment Plates  
Plaques pour petits fragments  
Placas para fragmentos pequeños  
Piaçce per piccoli frammenti



M36.248.02 - M36.248.12

Löcher . Holes . Trous		
L = mm	Orificios . Fori	
20	2	M36.244.02
36	4	M36.244.04
44	5	M36.244.05
52	6	M36.244.06
60	7	M36.244.07
68	8	M36.244.08
76	9	M36.244.09
84	10	M36.244.10
100	12	M36.244.12
26	2	M36.244.22

Löcher . Holes . Trous		
L = mm	Orificios . Fori	
25	2	M36.248.02
37	3	M36.248.03
49	4	M36.248.04
61	5	M36.248.05
73	6	M36.248.06
85	7	M36.248.07
97	8	M36.248.08
121	10	M36.248.10
145	12	M36.248.12



Osteosynthese  
Osteosynthesis  
Ostéosynthèse  
Osteosintesis  
Osteosintesi

SHERMAN Knochenplatten und -schrauben  
SHERMAN Bone Plates and Bone Screws  
SHERMAN plaques et vis a os  
SHERMAN placas y tornillos para huesos  
SHERMAN placche e viti per ossa

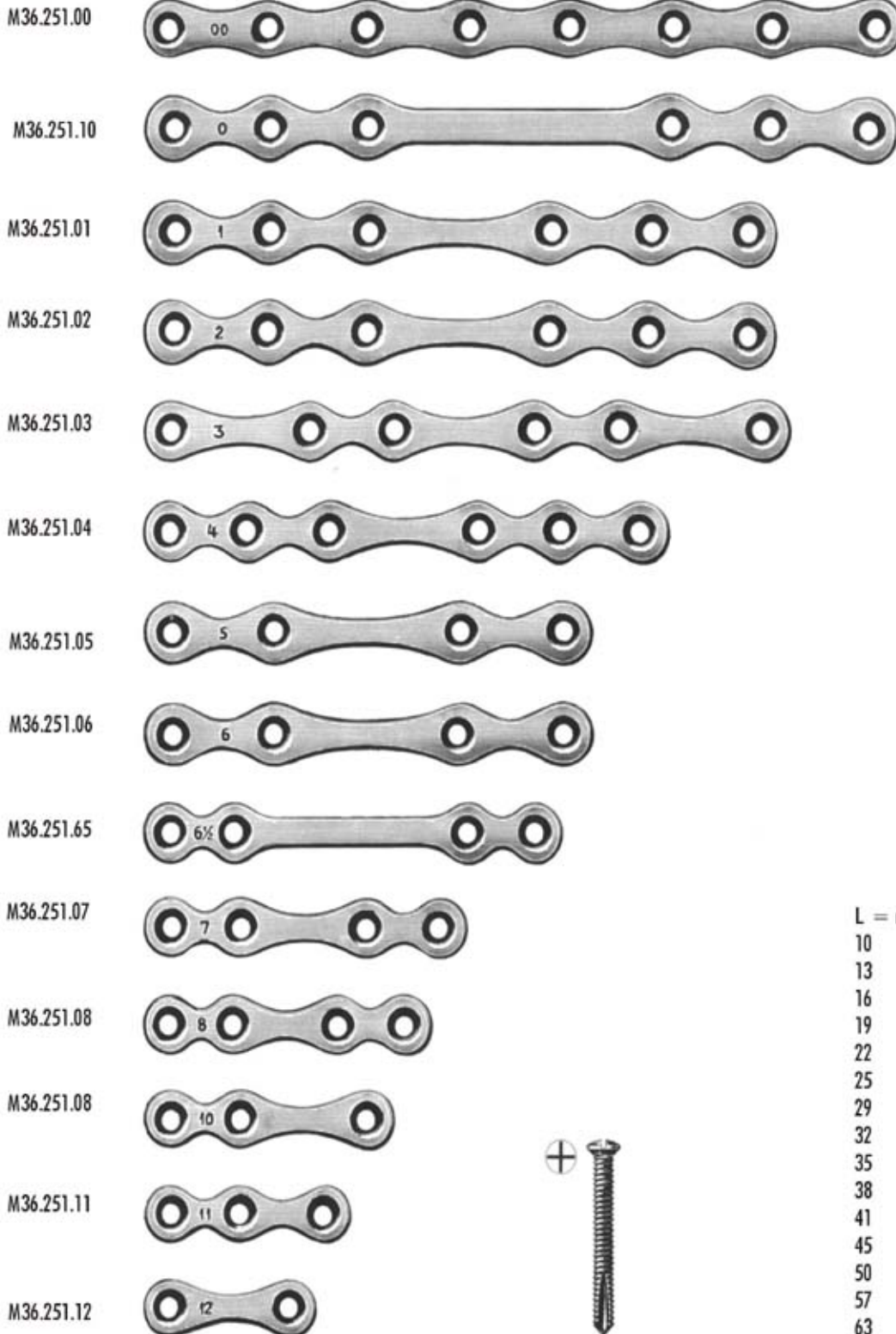

SHERMAN  
M36.256.10-M36.256.99  
4 mm Ø

L = mm

10	M36.256.10
13	M36.256.13
16	M36.256.16
19	M36.256.19
22	M36.256.22
25	M36.256.25
29	M36.256.29
32	M36.256.32
35	M36.256.35
38	M36.256.38
41	M36.256.41
45	M36.256.45
50	M36.256.50
57	M36.256.57
63	M36.256.63
75	M36.256.75
89	M36.256.89
99	M36.256.99

Osteosynthese  
Osteosynthesis  
Ostéosynthèse  
Osteosintesis  
Osteosintesi

Weitere Implantate für die Osteosynthese in Vorbereitung.  
Verlangen Sie unseren Spezialkatalog

Further implants for osteosynthesis are in preparation.  
Please ask for our special catalogue

D'autres implants pour l'osteosynthese sont en preparation.  
Demandez notre catalogue special, s.v.p.

Otros implantes para la osteosintesis en preparaion.  
Pidan nuestro catalogo especial, por favor.

Ulteriori impianti per la osteosintesi sono in preparazione  
chiedete il ns. Catalogo speciale, per favore

Hirnaht  
Brain Suture  
Suture cérébrale  
Sutura cerebral  
Sutura cerebrale

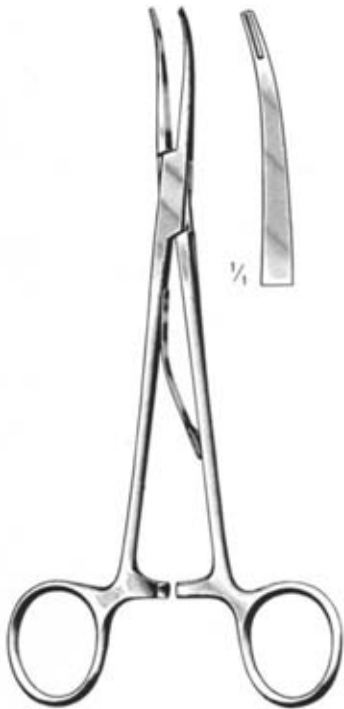

cm McKENZIE  
15 M40.011.15  
19 M40.011.19

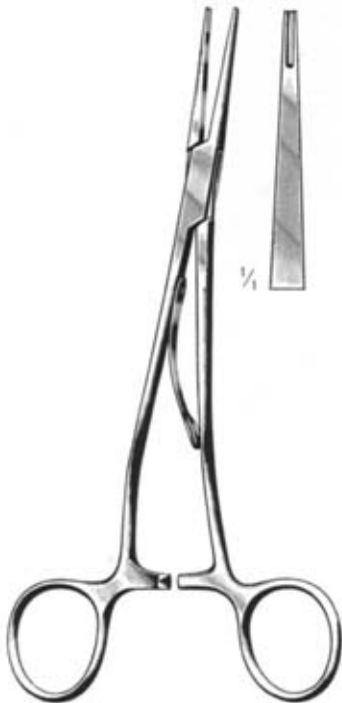

cm McKENZIE  
15 M40.013.15  
19 M40.013.19



cm SMITHWICK  
23 M40.015.23  
26 M40.015.26

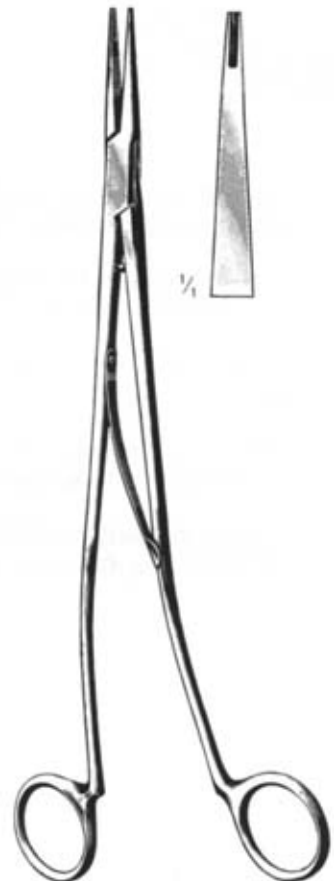

cm SWEET  
23 M40.017.23  
26 M40.017.26



OLIVECRONA-TOENNIS  
M40.019.14



M40.020.00  
148 x 40 x 6

M40.021.00



Schädelhalter  
Cervical Traction Tongs  
Pincés de traction crânienne  
Pinzas de tracción cranial  
Pinze per trazione craniale



CRUTCHFIELD  
M40.025.01



CRUTCHFIELD  
M40.025.02



M40.026.35  
3,5 mm ∅



M40.026.50  
3,5 mm ∅

Kopfhautkammer, -anlegezange  
Scalp hemostasis Clip, Applying Forceps  
Pince hémostatique pour le cuir chevelu, pince à poser  
Pinza hemostática para cuero cabelludo, pinza para poner  
Pinza emostatica per il cuoio capelluto, pinza per applicare e togliere



RANEY  
M40.027.00



RANEY  
M40.028.00

Nervhaken  
Nerve Retractors  
Ecarteurs à nerfs  
Separadores para nervios  
Divaricatori per nervi



DANDY  
M40.051.20  
20 cm

DANDY  
M40.052.20  
20 cm

DANDY  
M40.053.20  
20 cm



CUSHING  
M40.056.28

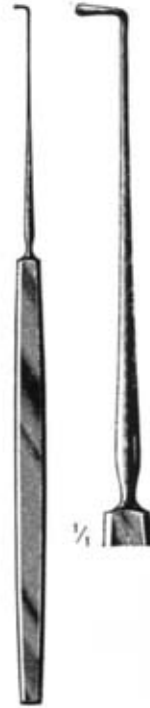

CUSHING  
M40.058.28



GRAHAM  
M40.061.16



SACHS  
M40.064.18



ADSON  
M40.068.20  
20 cm

ADSON  
M40.069.20  
20 cm

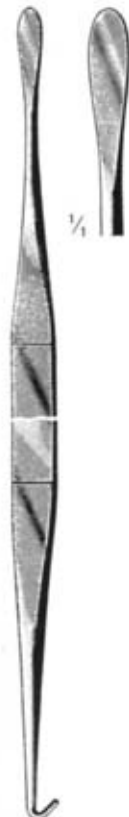

SMITHWICK  
M40.070.29  
20 cm

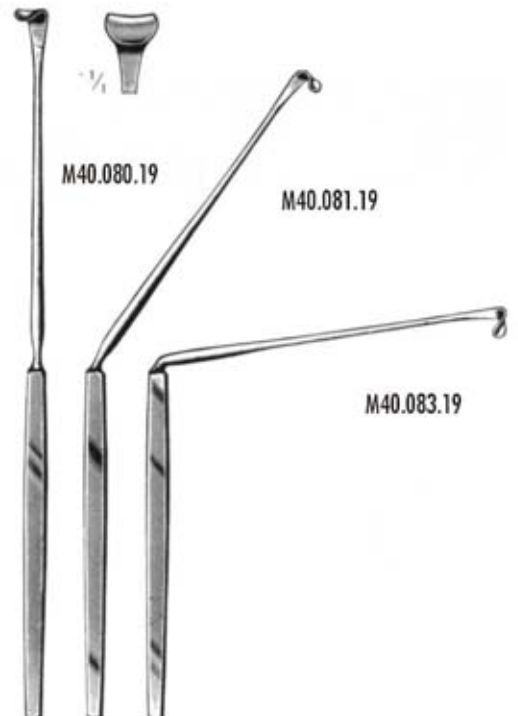

LOVE  
M40.080.19-M40.083.19

Neurochirurgie  
Neurosurgery  
Neurochirurgie  
Neurocirugia  
Neurochirurgia



De MARTEL  
M40.090.33  
33 cm



De VILBISS  
M40.096.21  
21 cm



cm OLIVECRONA  
30 M40.092.30  
40 M40.092.40  
50 M40.092.60  
70 M40.092.70



GIGLI  
M40.094.00

Dura-Dissektoren . Dura Dissectors . Dissecteurs à duremère  
Descoladores para la duramadre . Scollatori per la duramadre



TENNIS  
M40.141.25



SACHS  
M40.143.21



SACHS  
M40.145.21



MILLIGAN  
M40.147.21

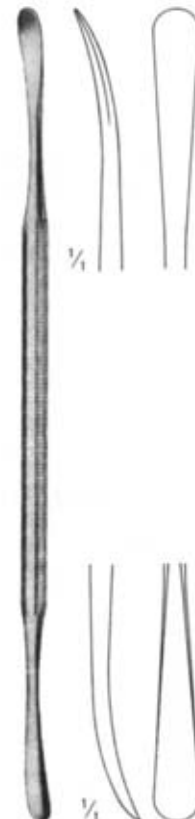

M40.149.22



DAVIS  
M40.151.24

Neurochirurgie  
Neurosurgery  
Neurochirurgie  
Neurocirugía  
Neurochirurgia

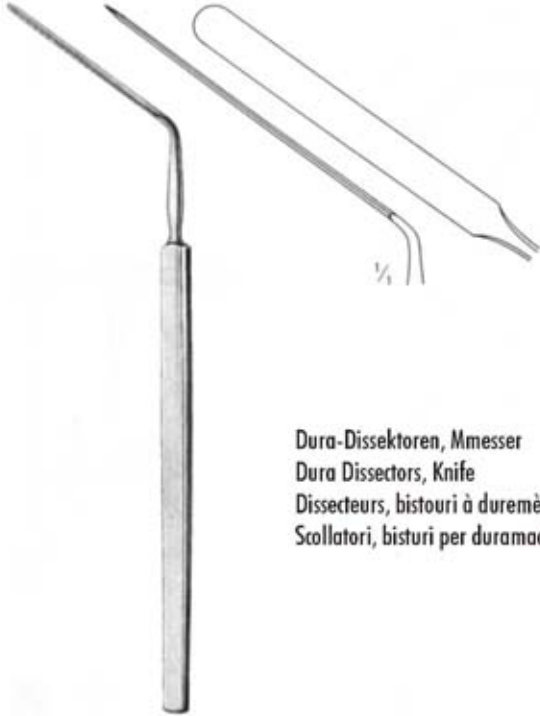

Dura-Dissektoren, Mmesser  
Dura Dissectors, Knife  
Dissecteurs, bistouri à duremère  
Scollatori, bisturi per duramadre

HORSLEY  
M40.155.20  
20 cm

PENFIELD  
M40.11.01  
17,5 cm

PENFIELD  
M40.161.02  
19,5 cm



PENFIELD  
M40.161.03  
19,5 cm



HALLE  
M40.170.20

Hypophysenpinzetten . Hypophyseal Forceps . Pincès à  
Hypophyse . Pinzas hipófisis . Pinze per ipofise



ADSON  
M40.210.23



ADSON  
M40.211.23



ADSON  
M40.213.23

Hirnspatel, Saugrohre  
 Brain Spatulas, Aspir. Tubes  
 Spatules cérébr., tubes d'aspir.  
 Espátulas cerebra., tubos de aspir.  
 Spatole cerebr., tubi per aspiraz.



mm CUSHING  
 7/9 M40..250.07  
 11/13 M40..250.11  
 15/18 M40..250.15  
 18/22 M40..250.18



mm OLIVECRONA  
 7/9 M40.253.07  
 11/13 M40.253.11  
 15/18 M40.253.15  
 18/22 M40.253.18



mm HEIFETZ  
 8 M40.260.08  
 11 M40.260.11  
 14 M40.260.14  
 17 M40.260.17



ADSON  
 M40.290.21  
 21 cm/4 mm

Charr.	30°	75°
6	M40.195.06	M40.297.06
7	M40.195.07	M40.297.07
8	M40.195.08	M40.297.08
9	M40.195.09	M40.297.09
10	M40.195.10	M40.297.10
11	M40.195.11	M40.297.11
12	M40.195.12	M40.297.12



FRAZIER  
 M40.295.06-M40.297.12  
 19 cm

Wirbelkörperspreizer . Lamina Spreaders  
 Ecarteurs pour corps vertébraux  
 Separadores para cuerpos vertebrales  
 Divaricatori per corpi vertebrali



FRAZIER  
 M40.298.12  
 12 cm/3 mm



CLOWARD  
 M40.401.16



INGE  
 M40.405.17-M40.405.27

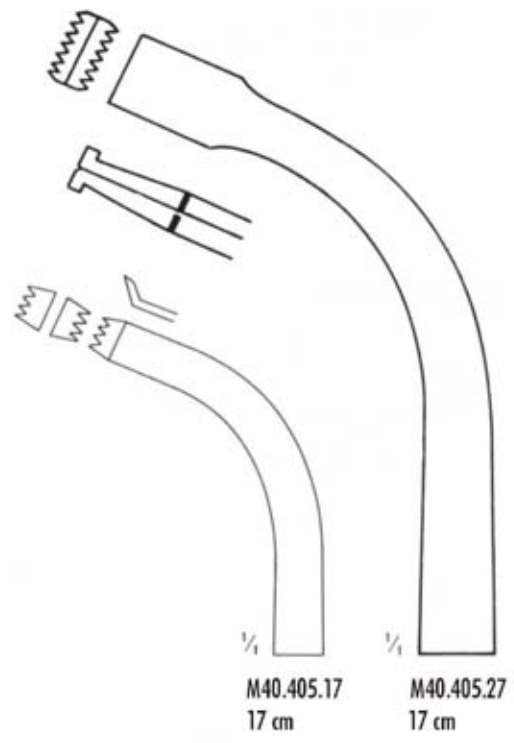

M40.405.17  
 17 cm

M40.405.27  
 17 cm



Laminektomie  
Laminectomy  
Laminectomie  
Laminectomía  
Laminectomia

Laminektomie-Zangen  
Laminectomy Rongeurs  
Pinces emporte-pièce a laminectomie  
Pinzas cortantes para lanietomia  
Pinze taglianti per laminectomia

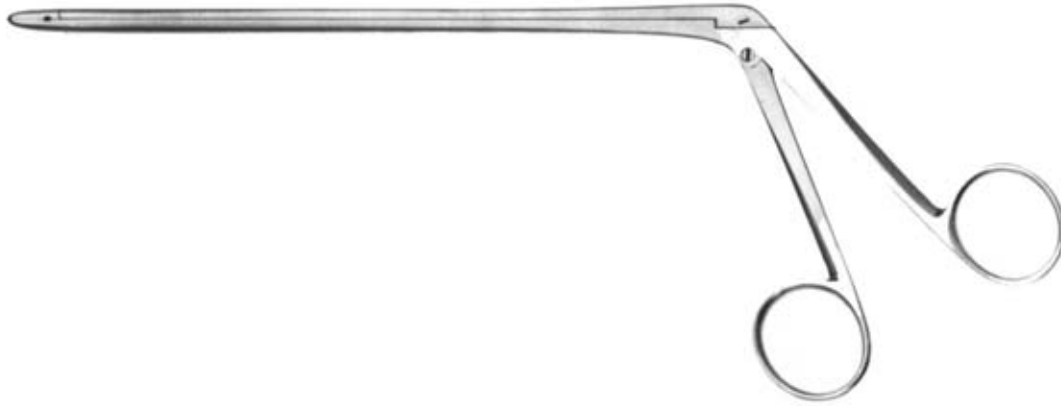

## CUSHING

2 mm

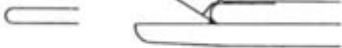

2 x 10 mm	L
M40.420.10	12,5 cm
M40.422.10	18,0 cm



2 x 10 mm /45°	L
M40.420.02	12,5 cm
M40.422.02	18,0 cm



2 x 10 mm /45°	L
M40.420.03	12,5 cm
M40.422.03	18,0 cm

## LOVE-GRUENWALD

3 mm



3 x 10 mm	L
M40.430.01	12,5 cm
M40.432.01	18,0 cm



3 x 10 mm /45°	L
M40.430.02	12,5 cm
M40.432.02	18,0 cm



3 x 10 mm /45°	L
M40.430.03	12,5 cm
M40.432.03	18,0 cm

## SPURLING

4 mm



4 x 10 mm	L
M40.440.10	12,5 cm
M40.442.10	18,0 cm



4 x 10 mm /45°	L
M40.440.02	12,5 cm
M40.442.02	18,0 cm

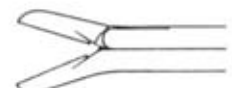

4 x 10 mm /45°	L
M40.440.03	12,5 cm
M40.442.03	18,0 cm

Laminektomie-Zangen  
Laminectomy Rongeurs  
Pincas emporte-pièce a laminectomie  
Pinzas cortantes para laniectomia  
Pinze taglienti per laminectomia

Laminektomie  
Laminectomy  
Laminectomie  
Laminectomía  
Laminectomia

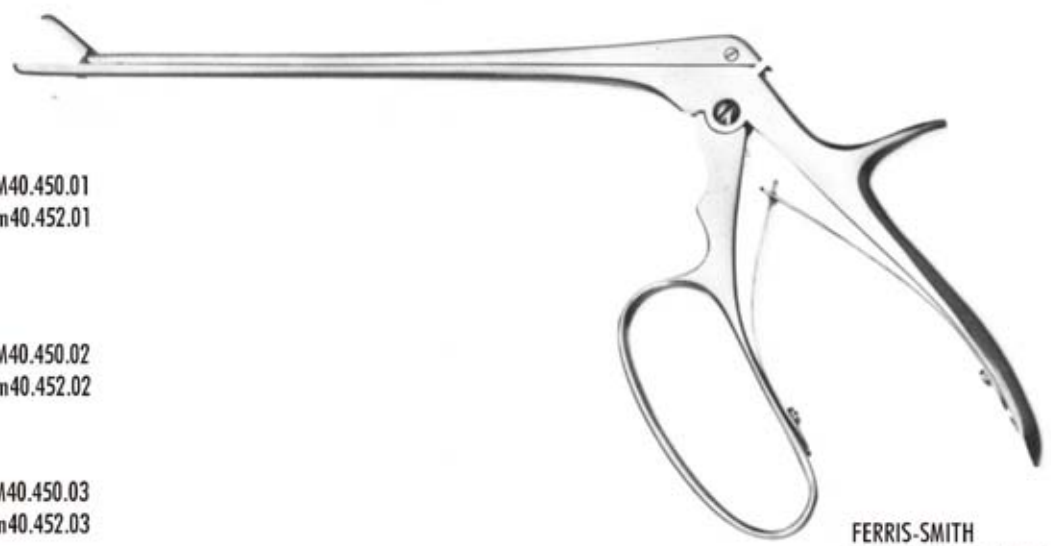
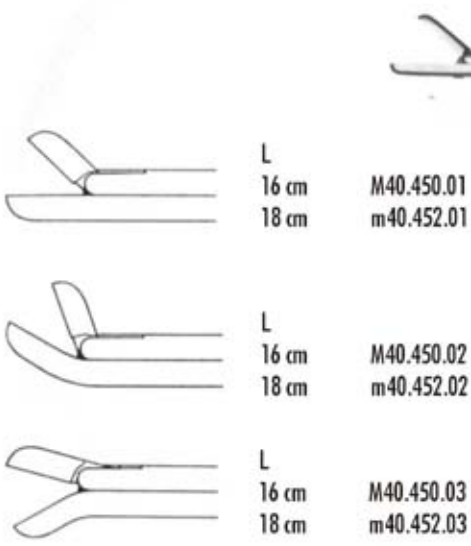
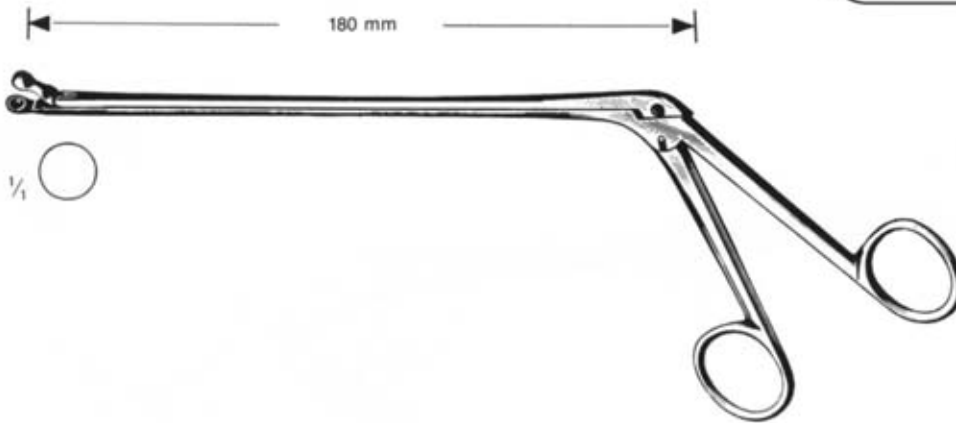

FERRIS-SMITH  
M40.450.01-M40.452.03  
3 x 10 mm

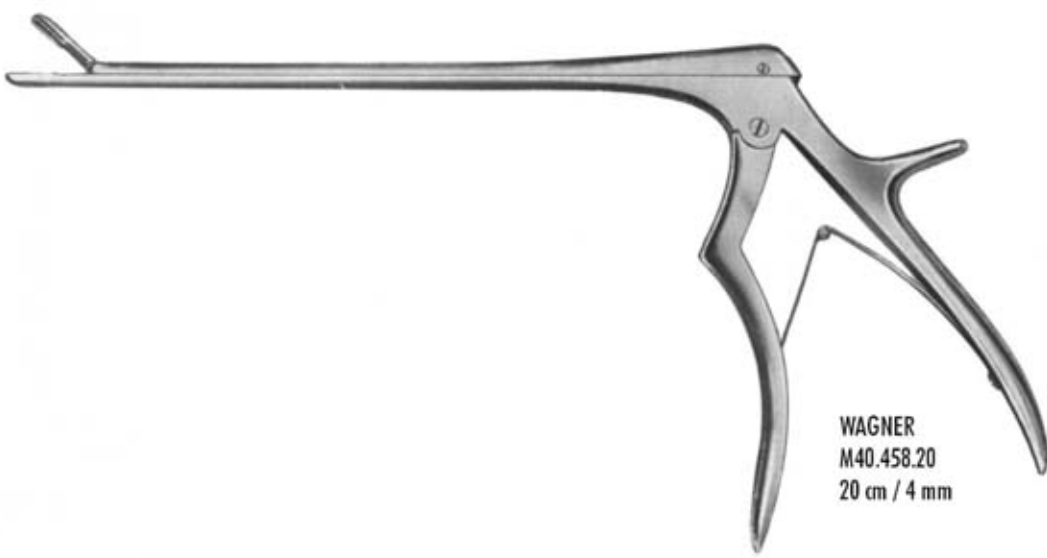

WAGNER  
M40.458.20  
20 cm / 4 mm

Laminektomie  
Laminectomy  
Laminectomie  
Laminectomía  
Laminectomia

Bandscheiben-Stanzen  
Intervertebral Disc Rongeurs  
Pincas emporte-pièce pour lames intervertébrales  
Pinzas sacabocado para discos intervertebrales  
Pinze taglianti per dischi intervertebrali

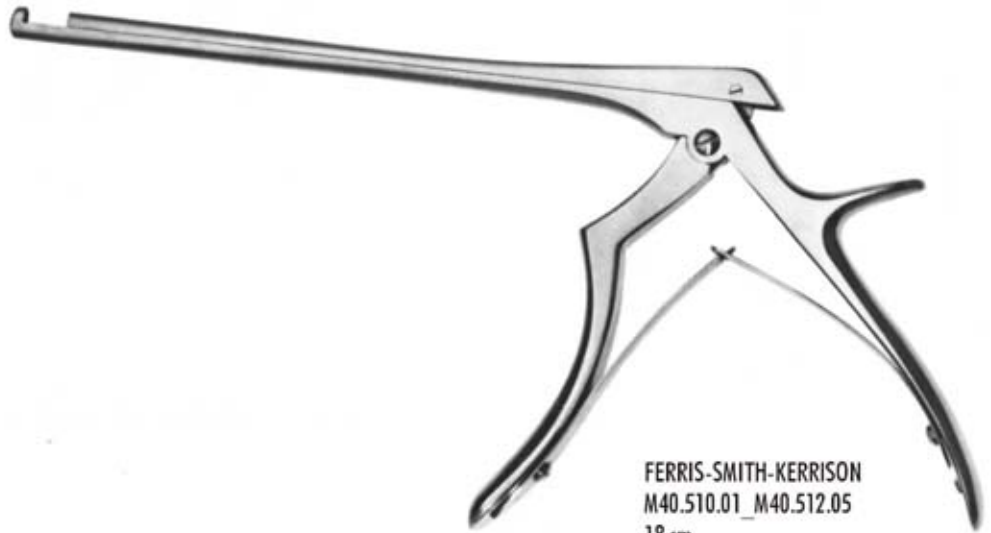

FERRIS-SMITH-KERRISON  
M40.510.01\_M40.512.05  
18 cm

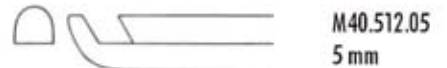
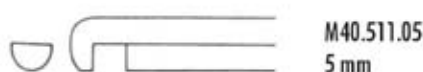
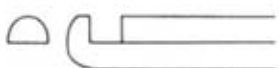
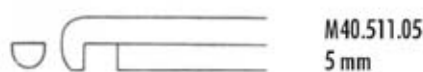
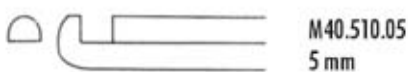
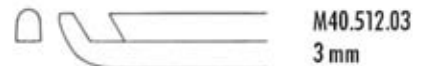
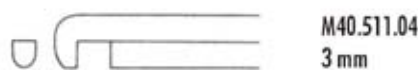
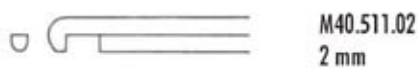

Bandscheiben Stanzen  
Intervertebral Disc Rongeurs  
Pinces emporte-pièce pour lames intervertébrales  
Pinzas sacabocado para discos intervertebrales  
Pinze taglianti per dischi intervertebrali

Laminektomie  
Laminectomy  
Laminectomie  
Laminectomía  
Laminectomia

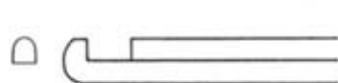
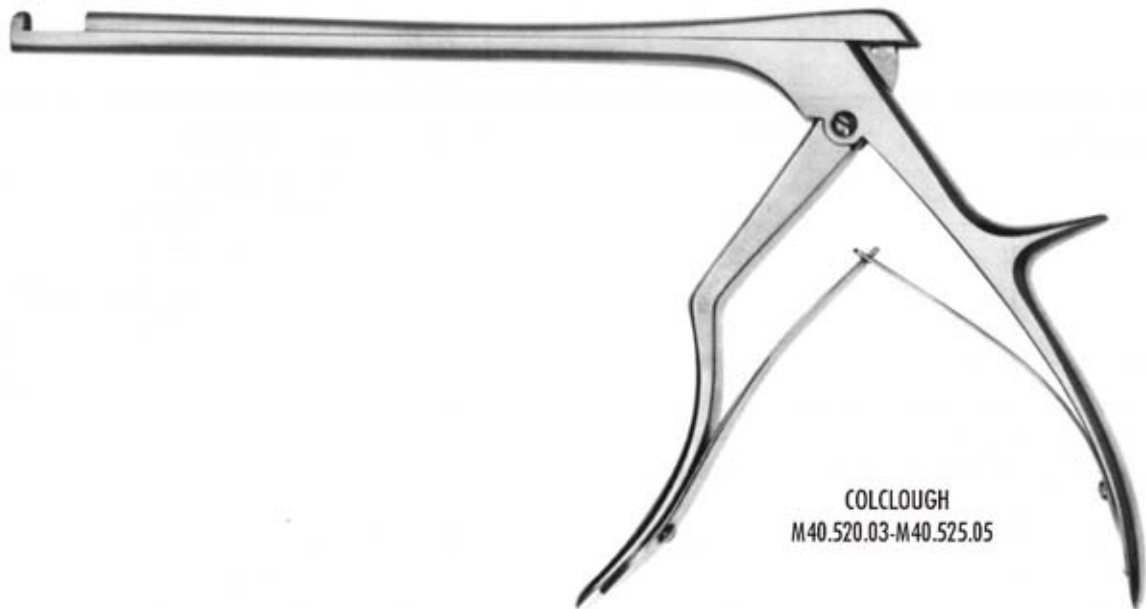

L	3 mm
15 cm	M40.520.03
20 cm	M40.522.03

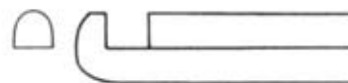

L	5 mm
15 cm	M40.520.05
20 cm	M40.522.05

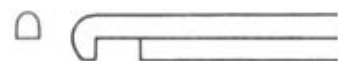

L	3 mm
15 cm	M40.524.03
20 cm	M40.524.03

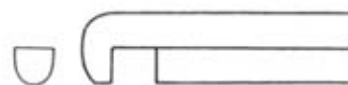

L	5 mm
15 cm	M40.524.05
20 cm	M40.524.05



L	3 mm
15 cm	M40.527.03
20 cm	M40.527.03

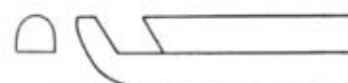

















L	5 mm
15 cm	M40.527.05
20 cm	M40.527.05

Neuro-, Gefäßchirurgie  
 Neuro, Vascular Surgery  
 Neurochir., Chir. vascul.  
 Neurocir., Cir. vascular  
 Neurochir., Chir. vascolare

Temporäre Clips = vergoldete Federenden  
 Temporary Clips = gold plated spring ends  
 Clips temporaires = vouts des ressorts dorés  
 Clips temporarios = extremos de lo resortes dorados  
 Clips temporari = estremo della molla dorato

## SASARGIL Clips "Mini"

MINI 	Permanent			Temporary			
	Maulöffnung Opening Ouverture Abertura Apertura	Maullänge Length of Jaws Longueur des mors Largo de la boca Lunghezza die morsi	Schließkraft Closing Force Force de fermeture Fuerza de compresión Forza di compressione	Maulöffnung Opening Ouverture Abertura Apertura	Maullänge Length of Jaws Longueur des mors Largo de la boca Lunghezza die morsi	Schließkraft Closing Force Force de fermeture Fuerza de compresión Forza di compressione	
	M40.570.30	3,0 mm	3 mm	M40.571.30	3,0 mm	3 mm	100-130 g (0,98-1,28 N)
	M40.572.30	3,5 mm	3 mm				
	M40.580.35	3,5 mm	5 mm	M40.581.35	3,5 mm	5 mm	
	M40.582.35	3,0 mm	3 mm	M40.581.35	3,5 mm	5 mm	
	M40.584.33	3,3 mm	5 mm				
	M40.690.30	3,0 mm	5 mm				
	M40.692.35	3,5 mm	5 mm				
	M40.694.35	3,5 mm	5 mm				
	M40.696.33	3,3 mm	5 mm				
	M40.698.30	3,0 mm	5 mm				
	M40.710.40	4,0 mm	7 mm	M40.711.40	4,0 mm	7 mm	40-50 g (0,39-0,49 N)
	M40.712.38	3,8 mm	7 mm	M40.713.38	3,8 mm	7 mm	
	M40.714.35	3,5 mm	7 mm	M40.714.35	3,5 mm	7 mm	
	M40.718.50	5,0 mm	7 mm				
	M40.766.40	4,0 mm	7 mm				





















Anlegezangen . Applying Forceps . Pincas de pose . Pinzas de aplicación . Pinze per posizionare



E.p.  
 MINI M40.772.21  
 STANDARD M40.774.21  
 21 cm

XASARGIL Clips  
"Standard"

Neuro-, Gefäßchirurgie  
Neuro, Vascular Surgery  
Neurochir., Chir. vascul.  
Neurocir., Cir. vascular  
Neurochir., Chir. vascolare

STANDARD 	Permanent			Schließkraft Closing Force  Force de fermeture Fuerza de compresión Forza di compressione	Temporary			
	Maulöffnung Opening  Ouverture  Abertura  Apertura	Maullänge Length of Jaws  Longueur des mors  Largo de la boca  Lunghezza die morsi			Maulöffnung Opening  Ouverture  Abertura  Apertura	Maullänge Length of Jaws  Longueur des mors  Largo de la boca  Lunghezza die morsi	Schließkraft Closing Force  Force de fermeture Fuerza de compresión Forza di compressione	
	M40.720.55	5,5 mm	7 mm	119.149 g (1,8-1,37 N)				
	M40.722.53	5,3 mm	7 mm					
	M40.724.48	4,8 mm	7 mm					
	M40.726.50	5,0 mm	7 mm					
	M40.728.68	6,8 mm	7 mm					
	M40.730.60	6,0 mm	9 mm			M40.731.73	7,3 mm	9 mm
	M40.732.60	6,0 mm	9 mm			M40.733.73	7,3 mm	9 mm
	M40.734.58	5,0 mm	9 mm			M40.735.63	6,3 mm	9 mm
	M40.738.75	7,5 mm	9 mm					
	M40.740.80	6,8 mm	15 mm					
	M40.742.65	5,8 mm	11 mm					
	M40.744.58	5,8 mm	11 mm					
	M40.750.80	8,0 mm	15 mm		100-130 g (0,98-1,28 N)	*M40.751.00	10,0 mm	15,0 mm
	M40.752.75	7,5 mm	15 mm			*M40.753.93	9,3 mm	15,0 mm
	M40.754.65	6,5 mm	15 mm	*M40.755.80		8,0 mm	15 mm	
	M40.770.68	6,8 mm	9 mm	110.140 g (1,08-1,37 N)	*PILOT-Clips			
	M40.780.38	3,8 mm	7 mm					
					M40.761.12	12,0 mm	20,0 mm	
					*M40.763.11	11,5 mm	20,0 mm	
							80-100 g (0,78-0,98 N)	

Ophthalmologie  
Ophthalmology  
Ophtalmologie  
Oftalmología  
Oftalmologia

Sperrelevatoren  
Eye Specula  
Blépharostats  
Blefarostatos  
Blefarostati

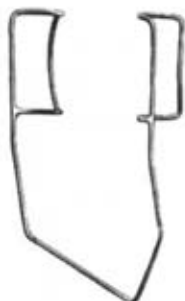

cm **BARRAQUER (Colibri)**  
3 M42.101.03  
4 M42.101.04



**BOWMAN**  
M42.104.07  
7 cm

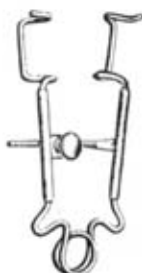

**RITCHETT**  
M42.105.06  
7 cm



**SMITH**  
M42.106.05  
5 cm



**CLARK**  
M42.107.08  
8 cm



cm **GRAEFE**  
7 M42.109.06  
9 M42.109.07



**WEEK**  
M42.110.08  
8 cm

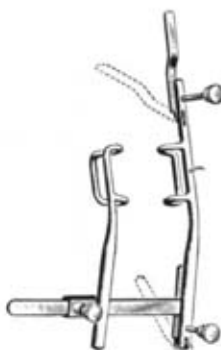

**ARRUGA**  
M42.111.07  
7 cm rechts  
right . à droite  
destro

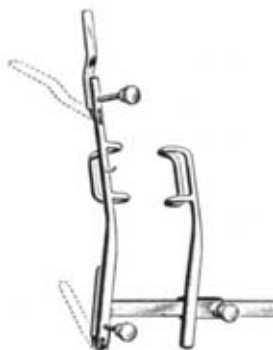

**ARRUGA**  
M42.113.07  
7 cm links  
a la izquierda  
sinistro



**MURDOCK**  
M42.115.05  
5 cm



**MELLINGER-AXENFELD**  
M42.121.07  
7 cm



**MELLINGER-AXENFELD**  
M42.123.07  
7 cm



cm **MELLINGER**  
5 M42.125.05  
7 M42.127.08



**LISTER-BURCH**  
M42.127.98  
8 cm



**WILLIAMS**  
M42.128.08  
8 cm

Ophthalmologie  
Ophthalmology  
Ophthalmologie  
Oftalmología  
Oftalmologia

Sperrelevatoren  
Eye Specula  
bléharostats  
Blesfarostatos  
Blefarostati



LANCASTER  
M40.129.07  
7 cm



ZIEGLER  
M40.120.07  
7 cm



CASTROVIEJO  
M42.132.08  
8 cm



PARK  
M42.133.08  
8 cm



MUELLER  
M42.135.07  
7 cm



GOLDSTEIN  
M42.137.07  
3 cm



STEVENSON  
M42.139.07  
7 cm



JEAGER  
M42.150.11  
11 cm

Lidplatte  
Lid Plate  
Plaque à paupières  
Placa para párpados  
Placca per palpebre

Starmesser  
Cataract Knives  
Couteaus à cataracte  
Cuchilos para catarata  
Coltelli per cataratta



GRAEFE  
M42.170.00-M42.170.03



M42.170.00  
Fig. 0



M42.170.01  
Fig. 1



M42.170.02  
Fig. 2



M42.170.03  
Fig. 3



DEUSCHMANN  
M42.172.13  
13 cm



Ophthalmologie  
 Ophthalmology  
 Ophtalmologie  
 Oftalmología  
 Oftalmologia

Verschiedene Augenmesser  
 Vario Eye Jbuves  
 Couteaux oculaires divers  
 Cuchillos oculares varios  
 Coltelli diversi per oculistica



M42.180.01-M42.218.12

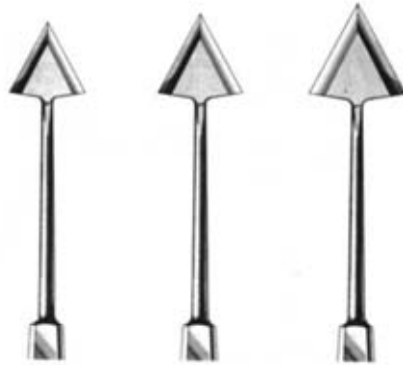

**JAEGER**  
 M42.180.01 Fig. 1  
 M42.180.03 Fig. 2  
 M42.180.03 Fig. 3



**JAEGER 45°**  
 M42.181.01 Fig. 1  
 M42.181.02 Fig. 2  
 M42.181.02 Fig. 3



**BERENS**  
 M42.183.13  
 13 cm



**CASTROVIEJO**  
 M42.185.13  
 4 x 13  
 13 cm



**GRAEFE**  
 M42.187.13  
 13 cm



**KNAPP**  
 M42.202.01 Fig. 1



M42.202.02 Fig. 2



M42.202.03 Fig. 3



**ZIGLER**  
 M42.210.01 Fig. 1 5 mm  
 M42.210.02 Fig. 2 6 mm  
 M42.210.03 fig. 3 7 mm



**DEAN**  
 M42.213.12  
 12,5 cm



**BOWMAN**  
 M42.214.04  
 0,4 mm  
 13 cm



M42.214.08  
 0,8 mm  
 13 cm



**WHEELER**  
 M42.218.12  
 12 cm

Verschiedene Augenmesser, Frmdkörper-Instrumente, Hornhaut-Schaber und Dissektoren, Star- und Fremdkörper-Nadeln, Sklerotome, Fixiergabel.  
 Various Eye Knives, Foreign Body Instruments, Corneal Scarifiers and Dissectors, Cataract and Foreign Body Needles, Sclerotomes, Fixation Fork.  
 Divers couteaux oculaires, Instruments à corps étrangers, Scarificateurs et dissecteurs cornéens, Aiguilles à cataracte et à corps étrangers, Sclérotomes, fourchette à fixation.  
 Cuchillos oculares varios, Instrumentos para cuerpos extranjerios, escarificadores y de fijación.  
 Coltelli oculistici diversi, Strumenti per corpi estranei, Scarificatori e scollatori per la cornea, Aghi per cataratta e per corpi estranei, Sclerotomi, Forchetta di fissaggio.

Ophthalmologie  
 Ophthalmology  
 Ophtalmologie  
 Oftalmología  
 Oftalmologia



Ophthalmologie  
 Ophthalmology  
 Ophtalmologie  
 Oftalmología  
 Oftalmologia

Fremdkörper-Instrumente, Hornhaut-Dissektor, Extirpations-Meißel, Schiel-, Muskel-,  
 Linsen-, Extraktionshaken, Iris-, Wundhäkchen, Cystotome.  
 Foreign Body Instruments, Corneal Dissector, Extirpation Chisel, Strabismus,  
 Muscle, Lens, and Extraction Hooks, Iris and Delicate Retractors, Cystotomes.  
 Instruments à corps étrangers, Dissecteur cornéen, Ciseaux à extirpation, Crochets  
 à strabisme, musculaires, pour la lentille, à extraction et à iris, Kystitomes.  
 Instrumentos para cuerpos extráneos, Disecador corneal, Cíncel de extirpación,  
 Ganchos para estrabismo, musculares, para el cristalino y de extracción, Ganchitos  
 para iris, separadores finos.  
 Strumenti per corpi estranei, Scollatore corneale, Scalpelli per estirpazione, Uncini  
 per strabismo, muscolare, per cristallino e per estrazione, Uncini per iride, Divari-  
 catori fini, Cistitomi.

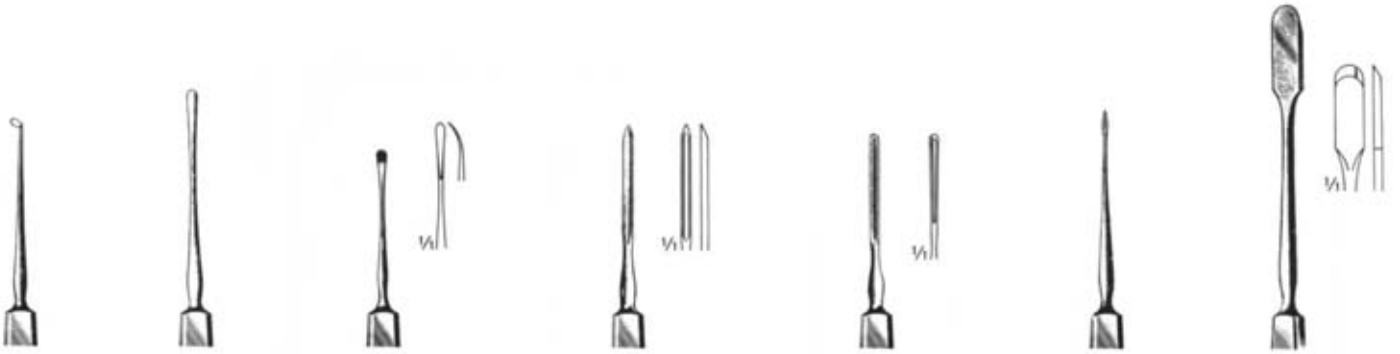

Ophthalmologie  
Ophthalmology  
Ophthalmologie  
Oftalmología  
Oftalmologia

Chalazion-, Star-, Exenterations-Löffel  
Scoops and Curettes for Chalazios, Cataract, and Exenteration  
Curettes et cuillers pour chalazion, cataracte et exentération  
Curetas y cucharillas para chalazión, catarata y exentération  
Curette e cucchiai per calazio, cataratte e palpebre.

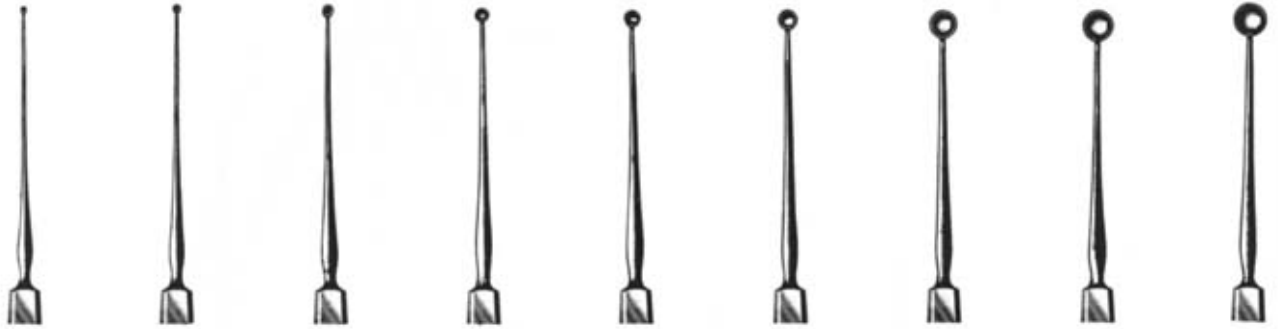

MEYHOEFER

M42.402.05	M42.402.10	M42.402.15	M42.402.18	M42.402.20	M42.402.25	M42.402.35	M42.402.40	M42.402.45
Ø mm 0,5	1,0	1,5	1,8	2,0	2,5	3,5	4,0	4,5

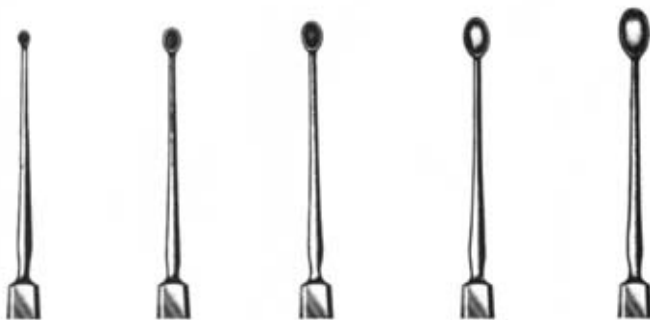

HEBRA

M42.404.10	M42.404.20	M42.404.20	M42.404.30	M42.404..35
Ø mm 1,0	2,0	2,5	3,0	3,5



EXENFELD  
M42.407.13



GRAEFE

DAVUEL

KNAPP

BUNGE

M42.410.01	M42.410.02	M42.412.01	M42.412.02	M42.414.02	M42.420.01	M42.420.02	M42.420.03
------------	------------	------------	------------	------------	------------	------------	------------

Ophthalmologie  
 Ophthalmology  
 Ophtalmologie  
 Oftalmología  
 Oftalmologia

Drahtschlingen  
 Wire Loops  
 Anses  
 Asas  
 Anse



LANG  
 M42.424.13



WEBER  
 M42.441.01 M42.441.02  
 Fig. 1 Fig. 2



SNELLEN  
 M42.443.13

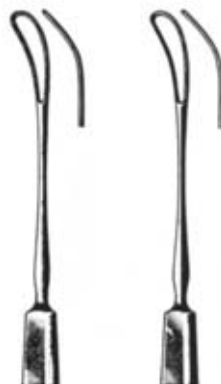

WILDER  
 M42.445.13 M42.447.13  
 Fig. 2



ARLT  
 M42.449.01 M42.449.02



WECKER  
 M42.461.13 M42.462.13



CULLER  
 M42.467.13



WELLS  
 M42.482.20



ARRUGA  
 M42.485.20



WADSWORTH-TODD  
 M42.487.14

Zyklodialyse . Cyclodialysis . Cyclodialyse . Ciclodialisi

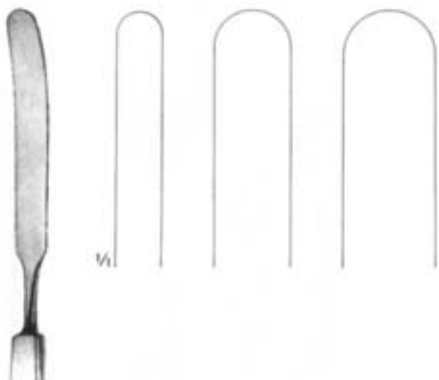

BANGERTER  
 M42.501.06 M42.501.10 M42.501.12  
 6 mm 10 mm 12 mm



M42.511.13-M42.517.09



CASTROVIEJO  
 M42.511.13  
 1,2 x 10 mm



CASTROVIEJO  
 M42.513.14  
 1,5 x 15 mm



ELSCHNIG  
 M42.515.14  
 1,2 x 12 mm



CASTROVIEJO  
 M42.517.09  
 0,8 x 15 mm

Zyklodialyse-spatel, Fremdkörper-Instrumente  
Cyclodiagnosis Spatule, Foreign Body Instruments  
Spatules à cyclodialyse, Instruments à corps étrangers  
Espátulas para ciclodálisis, Instrumentos para cuerpos extraños  
spatole pe ciclodialisi, Strumenti per corpi estrei

Ophthalmologie  
Ophthalmology  
Ophtalmologie  
Oftalmología  
Oftalmologia



CASTROVIEJO  
M42.521.12



WHEELER  
M42.523.12



mm	CASTROVIEJO
0,5	M42.525.05
0,75	M42.525.07
1,0	M42.525.10



DIX  
M42.542.12



DIX  
M42.544.12



DIX  
M42.546.13



DIX  
M42.548.13

Markier-Instrumente  
markers  
Marquers  
Marcadores  
Marcatori

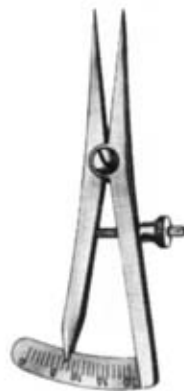

CASTROVIEJO  
M42.583.07  
0-20 mm



CONNIN-AMSLER  
M42.589.13



DASTOOR  
M42.590.06  
6 cm



HOLTH  
M42.593.09

Ophthalmologie  
Ophthalmology  
Ophtalmologie  
Ofthalmología  
Ofthalmologia

Tränengang-Dilatatoren  
Lachrymal Dilators  
Dilatateurs pour canal lacrymal  
Dilatadores para canal lacrimal  
dilatatori per canale lacrimale



WILDER  
M42.602.01 M42.602.02 M42.602.03



Fig. ZIEGLER  
1/2 M42.602.12  
3/4 M42.605.34  
5/6 M42.605.56



CASTROVIEJO  
M42.608.12



BOWMAN	Fig.	BOWMAN
M42.614.00	00/0	M42.616.00
M42.614.01	0/1	M42.616.01
M42.614.12	1/2	M42.616.12
M42.614.23	2/3	M42.616.23
M42.614.34	3/4	M42.616.34
M42.614.45	4/5	M42.616.45
M42.614.56	5/6	M42.616.56
M42.614.67	6/7	M42.616.67
M42.614.78	7/8	M42.616.78

Fig. 00 0 1 2 3 4 5 6 7 8  
Ø mm 0,7 0,8 0,9 1,1 1,3 1,4 1,5 1,6 1,7 1,9

Iris-Pinzetten . Iris Forceps  
Pincès à iris Pinzas para iris Pinze per iride



GRAEFE  
M42.802.07  
7 cm/1 mm



GRAEFE  
M42.803.07  
7 cm/1 mm



GRAEFE  
M42.804.07  
7 cm/1 mm



GRAEFE  
M42.805.07  
7 cm/1 mm

Iris-Pinzetten  
Iris Forceps  
Pinces à iris  
Pinzas para iris  
Pinze per iride



GRAEFE  
M42.810.10  
10 cm



GRAEFE  
M42.811.10  
10 cm



GRAEFE  
M42.813.10  
10 cm



GRAEFE  
M42.826.10  
10 cm



GRAEFE  
M42.821.10  
10 cm



GRAEFE  
M42.823.10  
10 cm



STEVENS  
M42.830.10  
10,5 cm



STEVENS  
M42.831.10  
10,5 cm



STEVENS  
M42.833.10  
10,5 cm



STEVENS  
M42.840.10  
10,5 cm



STEVENS  
M42.841.10  
10,5 cm



STEVENS  
M42.843.10  
10,5 cm



Iris-Pinzetten  
Iris Forceps  
Pinces à iris  
Pinzas para iris  
Pinze per iride



FOERSTER  
M42.850.08  
8,5 cm



FOERSTER  
M42.851.08  
8,5 cm



FOERSTER  
M42.852.08  
8,5 cm



FOERSTER  
M42.853.08  
8,5 cm



HESS  
M42.855.07  
7 cm/0,3 mm



HESS  
M42.857.07  
7 cm/0,3 mm



GILL  
M42.861.07  
7,5 cm/0,3 mm



GILL-HESS  
M42.863.07  
7,5 cm/0,3 mm

Zähne untern  
teeth below  
dents en bas  
dientes abajo  
denti in basso



GILL-HESS  
M42.865.07  
7,5 cm/0,3 mm

Zähne seitwärts  
lateral teeth  
dents laterales  
dientes laterales  
denti laterali

Iris, Strabismus-Pinzetten  
Irs, Straismus Forceps  
Pincès à iris et à strabisme  
Pinzas para iris y para estrabismo  
Pinze per iride e per strabismo

Ophthalmologie  
Ophthalmology  
Ophtalmologie  
Oftalmología  
Oftalmologia



FISCHER  
M42.869.07  
7 cm



BARRAQUER-KATZIN  
M42.881.07  
7cm/0,4 mm



TROUTMAN (Colibri)  
M42.883.07  
7cm/0,12 mm



BARRAQUER (Colibri)  
M42.885.07  
7 cm/,12 mm

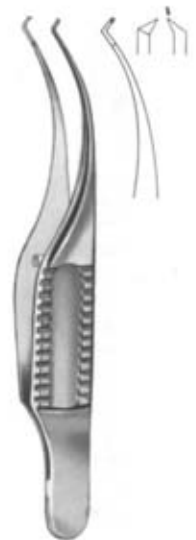

BARRAQUER (Colibri)  
M43.887.07  
7 cm/0,12 mm



KIRBY-ARTHUR  
M42.891.09  
9 cm/0,2 mm



KIRBY-ARTHUR  
M42.902.09  
9 cm/0k,2 mm



McCULLOUGH  
M42.9k02.09  
9,5 cm



McCULLOUGH  
M42.904.09  
9,5 cm

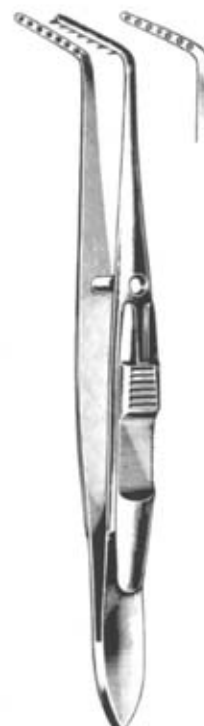

JAMESON  
M42.907.10  
L, 10 cm

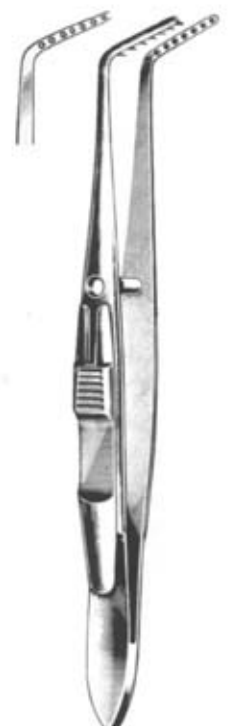

JAMESON  
M42.90.10  
R, 10 cm

Ophthalmologie  
Ophthalmology  
Ophtalmologie  
Oftalmología  
Oftalmologia

Strabismus-Pinzetten . Strabismus  
Forceps . Pincès à strabisme . Pinzas  
para estrabismo . Pinze per strabismo

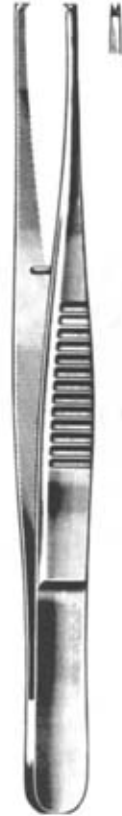

BONACCOLTO  
M42.914.10  
10 cm

BONACCOLTO  
M42.916.10  
10 cm

BONACCOLTO  
M42.920.11  
11 cm

DASTOOR  
M42.924.11  
11 cm

DASTOOR  
M42.926.11  
11 cm



Iris-Pinzetten . Iris Fordeps . Pincès à iris  
Pinzas para iris . Pinze per iride

BISHOP-HARMANN  
M4.940.05  
8,5 cm/0,5 mm

BISHOP-HARMAN  
M42.940.08  
8,5 cm/0,8 mm

BISHOP-HARMANN  
M42.942.08  
8,5 mm/0,5 mm

BISHOP-HARMAN  
M42.944.07  
8,5 cm/0,8 mm

Mod. Bonn  
M42.944.07  
7 cm/0,12 mm

Mod. Bonn  
M42.946.07  
7 cm/0,12 mm

Ophthalmologie  
Ophthalmology  
Ophtalmologie  
Oftalmología  
Oftalmologia

Iris-, Muskel-Pinzetten . Iris,  
Muscle Forceps . Pincés à iris, musculaires  
Pinzas para iris, musculares  
Pinze per iride, muscolari



Mod. Bonn  
M42.946.10  
10 cm/0,12 mm



Mod. Tübingen  
M42.950.10  
M42.954.10  
10 cm



Mod. Bonn  
M42.952.10  
42.956.10  
10 cm /0,12 mm



Mod. Tübingen  
M43.953.10  
M42.957.10  
10 cm



PRINCE  
M43.011.10  
10 cm

PRINCE  
M43.013.10  
10 cm



BERKE  
M43.015.20-M43.015.27

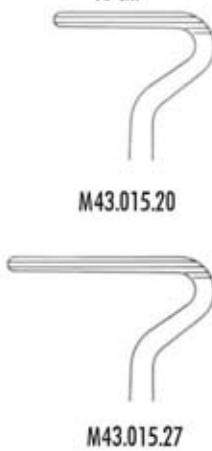

M43.015.20

M43.015.27

Rectus



TROUTMAN  
M43.017.08  
8,5 cm/0,8 mm

Vorderdammer-Pinzette  
Anterior Chamber forceps  
Pince à chambre antérieure  
Pinza para cámara anterior  
Pinza per camera anteriore

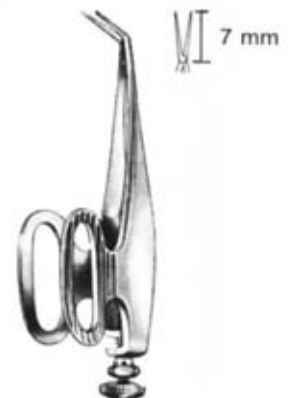

BARARAQUE  
M43.021.05  
5,5 cm/7 mm

Ophthalmologie  
Ophthalmology  
Ophtalmologie  
Oftalmologia  
Oftalmologia

Fixier-Pinzetten, Kapsel-Pinzette  
Fixation Forceps, Capsular Forceps  
Pincés à fixation, pince capsulaire  
Pinzas para fijación, pinza capsular  
Pinza per fissaggio, pinza capsulare



ELSCHNIG  
M43.046.11  
11 cm



CASTROVIJO  
M43.068.09



GRAEFE  
M43.050.11-M43.052.11



CASTROVIJO  
M43.069.09



BARRAQUER  
M43.074.10  
10 cm



LESTER  
M43.054.09  
9 cm



GREEN  
M43.076.05-M43.078.10



CASTROVIJO  
M43.066.09



schloß/catch/crémaillère/cierre/  
cremagliera



CASTROVIEJO  
M43.067.09



GILL-ARRUGA  
M43.101.07  
7,5 cm

Kapsel-Pinzetten  
Capsular Forceps  
Pinces capsulaires  
Pinzas capsulares  
Pinze capsulare



TERSON  
M43.103.09  
9 cm



KALT  
M43.106.10  
10 cm



ELSCHMIG  
M43.109.10  
10 cm



ARRUGA  
M43.111.10  
10 cm



ARRUGA  
M43.114.10  
10 cm



CASTROVIEJE  
M43.115.10  
10 cm



SCHWEIGGER  
M43.117.10  
10 cm



SCHWEIGGER  
M43.119.10  
10 cm



ELSCHMIG  
M43.121.10  
10 cm



HESS  
M43.125.06  
6 cm



HESS  
M43.127.06  
6,5 cm



FUCHS  
M43.129.07  
7 cm

Ophthalmologie  
Ophthalmology  
Ophtalmologie  
Oftalmología  
Oftalmologia

Naht-, Faden-, Pinzetten  
Suturing, Ligature Forceps  
Pincas à sutures et à ligature  
Pinzas para suturas y para ligaduras  
Pinze per sutura e per legatura



CASTROVIEJO

Zahn  
tooth  
dent  
diente

dente		
0,12 mm	M43.150.01	
0,3 mm	M43.150.03	
0,5 mm	M43.150.05	
1,0 mm	M43.150.10	M43.151.15
1,5 mm	M43.150.15	M43.151.15



MOORFIELD  
M43.164.10  
10 cm



St. MARTIN  
M43.166.07  
7 cm



Mod. Tübingen  
M43.181.10  
M43.185.10  
10 cm



PAUFIQUE  
M43.190.08  
M43.194.08  
8,5 cm



PAUFIQUE  
M43.202.08  
M43.206.08  
8,5 cm



McPHERSON  
M43.210.10  
M43.214.10  
10 cm



McPHERSON  
M43.220.10  
M43.224.10k  
10 cm

Pinzetten für Chalazion, Entropium, Trachom  
 Fordeps for Chalazio, Entropium, Trachoma  
 Pinzes à chalazion, à entropion, à granulations du trachome  
 Pinzas de chalaziòn y para tracoma  
 Pinze per calazio, per entropio e per trichiasi

Ophthalmologie  
 Ophthalmology  
 Ophtalmologie  
 Oftalmologia  
 Oftalmologia



AYER  
 M43.240.09  
 9 cm



AYER  
 M43.242.09  
 9 cm



LAMBERT  
 M43.246.09  
 9 cm



DESMARRES  
 M43.254.09-M43.258.09  
 9 cm



M43.254.09  
 Fig. 1

M43.256.09  
 Fig. 2

M43.258.09  
 Fig. 3



SNELLEN  
 M43.265.10  
 10 cm

SNELLEN  
 M43.267.10  
 10 cm



KANPP-LUER  
 M43.274.11  
 11 cm



Ophthalmologie  
Ophthalmology  
Ophtalmologie  
Oftalmología  
Oftalmologia

Augen-Knäulen  
Eye Cannula  
canules oculaires  
Cánulas oculares  
Cannule oculistiche



SCHEIE  
M43.302.28  
1,0 x 28 mm



SCHEIE  
M43.302.33  
1,5 x 33 mm



Mod. Tübingen  
M43.303.45



Mod. Hamburg  
M43.305.00



SIMCOE  
M43.306.00



Mod. Bonn  
M43.307.00



Mod. Bonn  
M43.309.00

Hornhaut-Trephinen . Corneal Tephines  
Trépanos cornéens . Trépanos corneales  
Trefine corneali



CASTROVIEJO  
M43.310.50-M43.311.01

∅ mm	CASTROVIEJO
5,0	M43.310.50
5,5	M43.310.55
6,0	M43.310.60
6,5	M43.310.65
7,0	M43.310.70
8,0	M43.310.80
9,0	M43.310.90
10,0	M43.310.00
11,0	M43.310.51



FRANCESCETTI  
M43.320.50-m43.321.00

∅ mm	CASTROVIEJO
5,0	M43.320.50
5,1	M43.320.51
6,0	M43.320.60
6,1	M43.320.61
7,0	M43.320.70
7,1	M43.320.71
8,0	M43.320.70
8,1	M43.320.81
9,0	M43.320.90
9,1	M43.320.91
10,0	M43.320.00

Ophthalmologie  
 Ophthalmology  
 Ophtalmologie  
 Oftalmologia  
 Oftalmologia

Tonometer . Toómetro  
 Tonometre



ELLIOT  
 M43.340.00  
 comp. = 4



SCHIOETZ  
 M43.404.00      M43.406.00  
 Skala      gerade      schräg  
 scale      straight      oblique  
 échelle      droite      oblique  
 dxcala      retta      obliqua

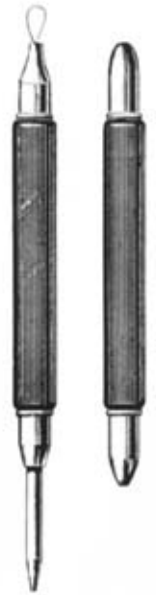

M43.428.09

Augen-Magnet  
 Eye Magnet  
 Aimant à corps étrangers  
 Imán para cuerpos extraños

Gilien-Pinzetten . Cilia Forceps  
 Pinces à épiler les cils . Pinzas  
 depilatorias . Pinze depilatorie



BEER  
 M43.420.09  
 9 cm



DOUGLAS  
 M43.422.09  
 9 cm



LITTAUER  
 M43.424.08  
 8,5 cm



BARRAQUER  
 M43.424.08  
 10,5 cm



M43.426.09  
 9 cm



GRADLE  
 M43.428.09  
 9 cm

Otologie  
Otology  
Otologie  
Otologia  
Otologia

Ohr-Spekula  
Ear specula  
Apéculems auriculaires  
Espéculos auriculares  
Specoli auricolari



HARTMANN  
M44.010.00  
Set = 4

- mm Ø  
① = 3  
M44.010.3k0
- ① = 4,5  
M44.010.45
- ② = 5,5  
M44.010.55
- ③ = 6,5  
M44.010.65
- ④ = 7,5  
M44.010.75



TOYNBEE  
M44.012.00  
Set = 3

- ② mm Ø  
= 5,5  
M44.012.55
- ③ = 6,5  
M44.044.012.65
- ④ = 7,5  
M44.012.75



GRUBER  
M44.014.00  
Set = 4

- ① mm Ø  
= 4,5  
M44.014.45
- ② = 5,5  
M44.014.45
- ③ = 6,5  
M44.014.65
- ④ = 7,5  
M44.014.75



GRUBER  
M44.015.00  
Set = 3

- ① mm Ø  
= 4,5  
M44.015.45
- ② = 5,5  
M44.015.55
- ③ = 6,5  
M44.015.65
- ④ = 7,5  
M44.015.75



BOUCHERON  
M44.018.00  
Set = 4

- ⑤ M44.018.55  
5 mm
- ⑥ M44.018.60  
6 mm
- ⑦ M44.018.70  
7 mm
- ⑧ M44.018.80  
8 mm

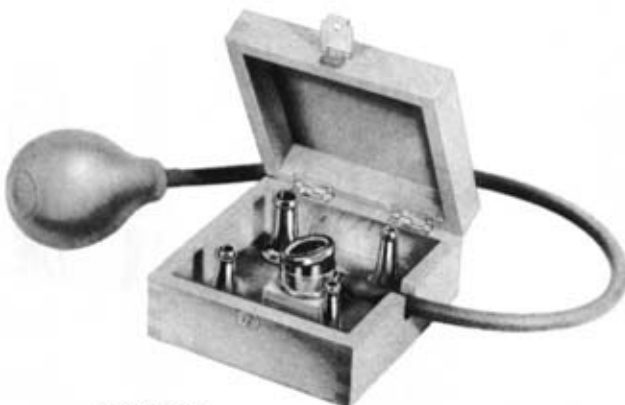

BRUENINGS  
M44.030.04  
compl.



SIEGLE  
M44.036.03  
compl

Stimmgabeln  
Tuning Forks  
Diapasons  
Diapasones  
Diapason



Alu

- |            |            |            |            |            |
|------------|------------|------------|------------|------------|
| M44.060.01 | M44.060.02 | M44.060.03 | M44.060.04 | M44.060.05 |
| C 128      | C 156      | C 512      | C 1024     | C 2048     |



Alu  
M44.061.00  
comp.



HARTMANN

- |            |            |            |            |            |
|------------|------------|------------|------------|------------|
| M44.070.01 | M44.070.02 | M44.070.03 | M44.070.04 | M44.070.05 |
| C 128      | C 156      | C 512      | C 1024     | C 2048     |



HARTMANN  
M44.071.00  
compl.

Otologie  
Otology  
Otologie  
Otologia  
Otologia



LUCAE  
M44.074.01  
C 128



M44.074.00  
neuroL.



RYDEL-SEIFFER  
M44.076.01  
C 64/c 128

Lrmapparat  
Noise Apparatus  
Assourdisseur  
Ensordecedor  
Assordatore



BARANY  
M44.080.00

Pulverbläser  
Powder Blowers  
Lance-Poudre  
Lanzapolvero  
Insuffiatoi per polvere

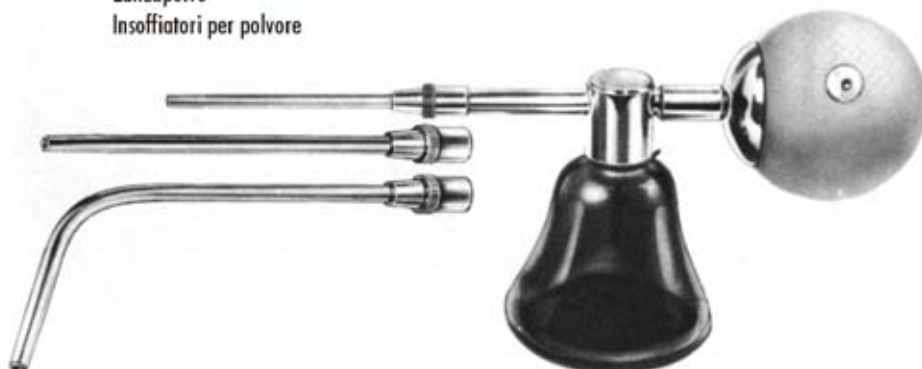

KABIERSKE  
M44.090.00  
30 cc

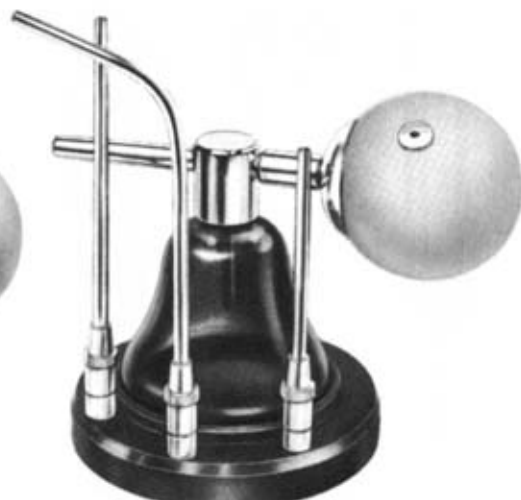

KABIERSKE  
M44.090.01  
30 cc

Otologie  
Otology  
Otologie  
Otología  
Otologia

Luftdusche, Ohrspritze  
Air Bag, Ear syringe  
Insufflateur dair, Seringue  
Insufflador de aire, Jeringa  
Insoffialrore daria, Siringa



M44.091.03



M44.091.04  
4 mm Ø



M44.091.15  
15 mm Ø



M44.091.17  
17 mm Ø



M44.091.22  
22 mm Ø

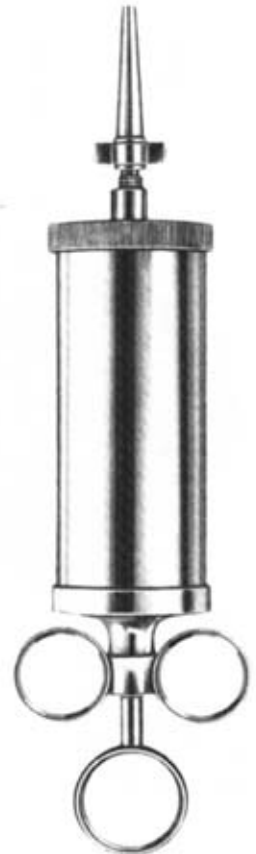

ml	REINER
50	M44.096.50
75	M44.096.75
100	M44.097.10
150	M44.097.15

**POLIZER**

M44.091.00 = ind. M44.091.15, M44.091.17, M44.091.2, M44.091.03  
M44.091.01 = ind. M44.091.15, M44.091.17, M44.091.2, M44.091.03, M44.091.04

Kürentten . Cutettes  
Curettes . Curetas  
Curette



Stumpf. Blunt  
mousses  
romas  
smusse



Fig. 00  
M44.109.00



0  
M44.110.00



1  
M44.110.01



2  
M44.110.02



3  
M44.110.03



4  
M44.110.04



5  
M44.110.05

schaft. Sharp  
tranchante  
cortantes  
taglianti



M44.111.00

M44.112.00

M44.112.01

M44.112.02

M44.112.03

M44.112.04

M44.112.05

stumpf. Blunt  
mousses  
romas  
smusse



M44.114.00

M44.115.00

M44.115.01

M44.115.02

M44.115.03

M44.115.04

M44.115.05

scharf. Sharp  
tranchantes  
cortantes  
taglianti



M44.116.00

M44.117.00

M44.117.01

M44.117.02

M44.117.03

M44.117.04

M44.117.05

Otologie  
Otology  
Otologie  
Otología  
Otologia

Katheter, Parazentesenadeln, Ohrmesserm Ohröffel  
Catheters, Paracentesis needles, Ear Nknives, Ear Spoons  
Sonder, Aiguiles à paracentèse, Couteaux auriculaires, cuilers  
Cateteres, Aguja para paracentesis, Cuchillos auriculares, Cucharas  
Cateeri, Aghi per paracentesi, Coltelli auricolari, Cuchiai

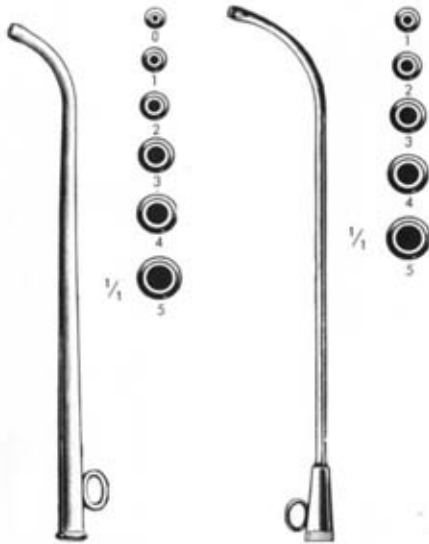

Fig.	HARTMANN	ITARD
0	M44.131.00	
1	M44.131.01	M44.133.01
2	M44.131.02	M44.133.02
3	M44.131.03	M44.133.03
4	M44.131.04	M44.133.04
5	M44.131.05	M44.133.05



POLITZER  
M44.150.18  
18 cm



POLITZER  
M44.151.16  
16,5 cm

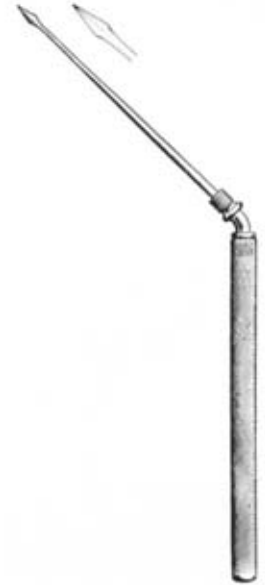

POLITZER  
M44.153.16



POLITZER  
M44.160.15  
15 cm



SEXTON  
M44.162.18  
18 cm



SEXTON  
M44.164.17  
17 cm



SEXTON  
M44.165.17  
17 cm



GROSS  
M44.170.12  
12 cm



GROSS  
M44.171.12  
12 cm

Schlingen, Hakchen, Pinzetten, Schnurer  
Loops, Hooklets, Dressing Forceps, Snares  
Anses, Crochets, Pincers, Serre-neud  
Asas, Ganchitos, Pinzas, Cierranudos  
Anse, Uncinetti, Pinze, Serranodi

Otologie  
Otology  
Otologie  
Otología  
Otologia

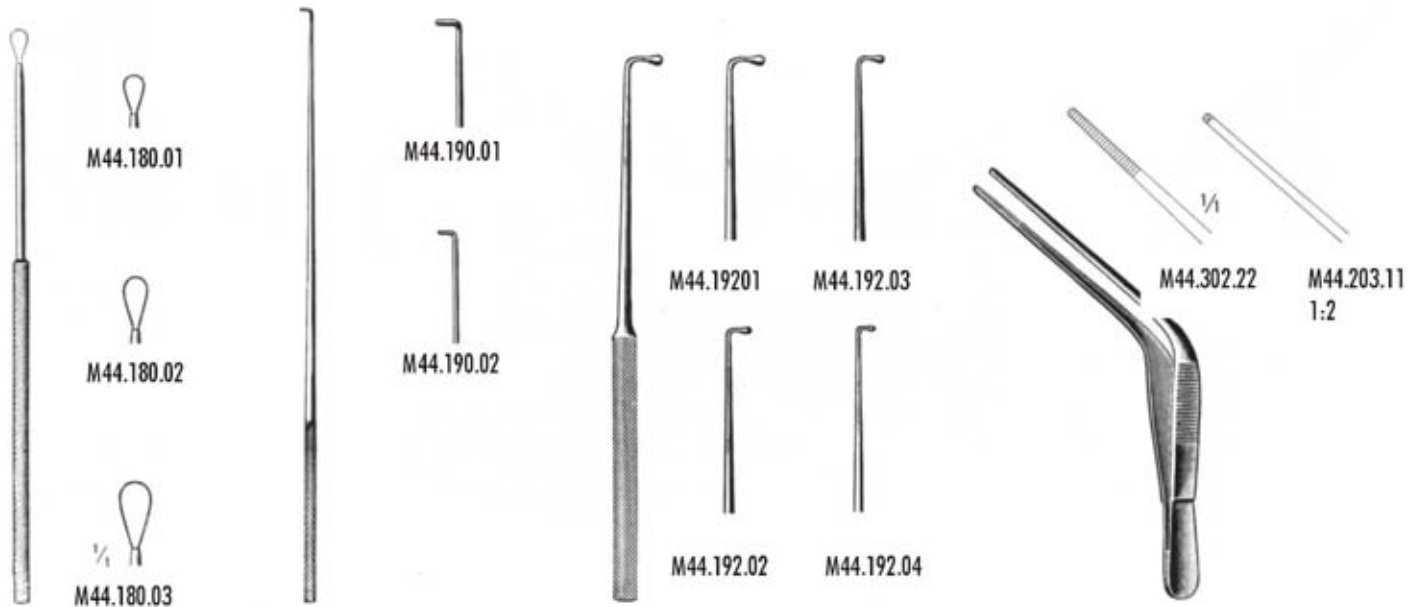

**BILLAU**  
M44.180.01-M44.180.03

**DAY**  
M44.190.01-M44.190.02

**WAGNER**  
M44.192.01-M44.192.04

**WILDE(TROELTISCH)**  
M44.201.11-M44.203.11  
12 cm



**LUCAE**  
M4.206.14  
14 cm



**LUCAE**  
M44.206.16  
16 cm



**KRAUSE**  
M44.220.16  
16 cm



**WILDE**  
M44.222.17  
17 cm



M44.225.02  
Dtzd./doz./douz/  
doc./dozz.



Ohrzängchen  
Ear Forceps  
Pincès auriculaires  
Pinzas auriculares  
Pinze auricolari



TILLEY  
M44.243.14  
14 cm

LITTAUER  
M44.241.12  
12 cm



HARTMANN  
M44.241.12  
12 cm



HARTMANN  
M44.241.14  
14 cm



QUIRE  
M44.251.10  
10 cm

Fremdkörperhebel  
Foreign Body Levers  
Leviers por corps étrangers  
Elevadores para cuerpos extraños  
Leve per corpi extranei



BUCK  
M44.253.11  
11 cm



M44.255.08-M44.275.08



HARTMANN-WULLSTEIN  
M44.255.08  
8,5 cm



HARTMANN-WULLSTEIN  
M44.257.08  
8,5 cm



cm	HARTMANN
8,5	M44.261.08
14,0	M44.161.14
16,0	M44.261.16



cm	HARTMANN
8,5	M44.263.08
14,0	M44.263.014



HARTMANN  
M44.265.08  
8,5 cm



Ø mm	HARTMANN
1,0	M44.267.20
2,5	M44.267.25
3,0	M44.267.30
8,5 cm	

○ 3 mm



HARTMANN  
M44.269.30  
8,5 cm



STRUEMPEL  
M44.271.08  
8,5 cm



HARTMANN  
M44.273.08  
8,5 cm

○ 2 mm



HARTMANN-HOFFMANN  
M44.275.08  
8,5 cm

Otologie  
Otology  
Otologie  
Otologia  
Otologia

Mikro-Orscherchen  
Micro Ear Scissors  
Ciseaux auriculaires micro  
Tijeras auriculares micro  
forbici auricolari micro



M44.310.40-M44.322.70



BELLUCCI  
M44.310.40  
micro mini  
4 mm



BELLUCCI  
M44.312.55  
micro standard  
5,5 mm



BELLUCCI  
M44.313.55  
microstandard  
5,5 mm



BELLUCCI  
M44.315.55  
5,5 mm



BELLUCI  
M44.317.55  
5,5 mm



SHEA  
M44.320.70  
7,0 mm



SHEA  
M44.321.70  
7,0 mm



SHEA  
M44.322.70  
7,0 mm

Mikro -Ohrzangchen  
Micro Ear Forceps  
Pinces auriculaires micro  
Pinzas auriculares micro  
Pinze auricolari micro



M44.350.40-M44.360.35



M44.350.40  
4 mm



M44.350.70  
7 mm



M44.352.40  
4 mm



M44.353.60  
6 mm



M44.355.60  
6 mm



M44.357.40  
4mm



M44.359.40  
4 mm



M44.360.35  
3,5 mm

Mikro-Ohrzängchen  
 Micro Ear Forceps  
 Pinces auriculaires micro  
 Pinzas auriculares micro  
 Pinze auricolari micro



M44.362.45-M44.383.30



M44.362.45  
4,5 mm



44.367.50  
5,0 mm



McGEE  
M44.371.40  
0,8 x 4,0 mm



JUERS  
M44.377.60  
6 mm



M44.363.45  
4,5 mm



M44.369.50  
5,0 mm



COS  
M44.373.30  
1,8 x 0,8 x 3,0 mm



HAUGH  
M44.381.30  
45° 3 mm



M44.365.45  
4,5 mm



GREVEN  
M44.370.50  
5,0 mm



JUERS  
M44.375.60  
6 mm



HAUGH  
M44.383.30  
45° 3 mm



DIETER  
M44.385.01-M44.387.02

Hammerkorp-Zwickzängchen  
 Malleus Nippers  
 Pinces pour latee du marteau  
 Pinzas para oña cabeza del martillo  
 Pinze per la testa del martello

Micro



M44.385.01



M44.385.02

Aufwärts  
 upward  
 wen haut  
 arriba  
 in alto

Abwärts  
 downward  
 en bas  
 abajo  
 in basso

mini



M44.387.01



M44.387.02

Mikro-Ohrzängchen  
Micro Ear Forceps  
Pinces auriculaires micro  
Pinzas auriculares micro  
Pinze auricolari micro

Modelle mit Ringgriff  
Ring Handle Patterns  
Modèles manches à anneaux  
Modelos mangos con anillos  
Modelli manici con anelli

Modelle mit bleistiftgriff  
Pencil Handle patterns  
Modèles manches crayon  
Modellos mango en forma de lapiz  
odelli manico forma matita



M44.410.00-M44.419.00  
micro  
RG



M44.420.00-M44.429.00  
micro-mini  
RG

M44.410.00

M44.412.00

M44.413.00

M44.415.00

M44.417.00

M44.419.00

M44.420.00

M44.422.00

M44.423.00

M44.425.00

M44.427.00

M44.429.00



M44.430.00

M44.432.00

M44.433.00

M44.435.00

M44.437.00

M44.439.00

M44.439.08

M44.440.00

M44.442.00

M44.443.00

M44.445.00

M44.447.00

M44.449.00



M44.430.k00-M4.439.08  
micro  
BG



M44.440.00-M44.449.0  
micromini  
BG

Mikro-Ohrzängchen  
 Micro Ear Forceps  
 Pincès auriculaires micro  
 Pinzas auriculares micro  
 Pinze auricolari micro



M44.510.00-M44.549.00  
 micro  
 RG

Modelle mit Ringgriff  
 Ring handle attens  
 Modèles manches à anneaux  
 Modelos mangos con anillos  
 Modelli manici con anelli



Modelle mit Bleistiftgriff  
 Pencil Handle Patterns  
 Modèles manches crayon  
 Modelos mango en forma de lapiz  
 Modelli manico forma matita

M44.610.00-M44.649.00  
 micro  
 RG

M44.510.00		M44.610.00
M44.511.00		M44.611.00
M44.513.00		M44.613.00
M44.514.00		M44.614.00
M44.515.00		M44.615.00
M44.516.00		M44.616.00
M44.517.00		M44.617.00
M44.518.00		M44.618.00
M44.519.00		M44.619.00
M44.520.00		M44.620.00

Ø 1 mm	Ø 1,5 mm	Ø 2 mm	Ø 2,5 mm		Ø 1 mm	Ø 1,5 mm	Ø 2 mm	Ø 2,5 mm
M44.522.00	M44.528.00	M44.534.00	M44.540.00		M44.622.00	M44.628.00	M44.634.00	M44.640.00
M44.523.00	M44.529.00	M44.535.00	M44.541.00		M44.623.00	M44.629.00	M44.635.00	M44.641.00
M44.525.00	M44.531.00	M44.537.00	M44.543.00		M44.625.00	M44.631.00	M44.637.00	M44.643.00
M44.527.00	M44.533.00	M44.539.00	M44.545.00		M44.627.00	M44.633.00	M44.639.00	M44.645.00
		M44.546.00					M44.646.00	
		M44.547.00					M44.647.00	
		M44.548.00					M44.648.00	
		M44.549.00					M44.649.00	

Mikro-Ohrzängchen  
Micro Ear Forceps  
Pincès auriculaires micro  
Pinzas auriculares micro  
Pinze auricolari micro



M44.550.00-M44.589.00  
micro-mini  
RG

Modelle mit Ringgriff  
Ring handle atterns  
Modèles manches à anneaux  
Modelos mangos con anillos  
Modelli mncici con anelli

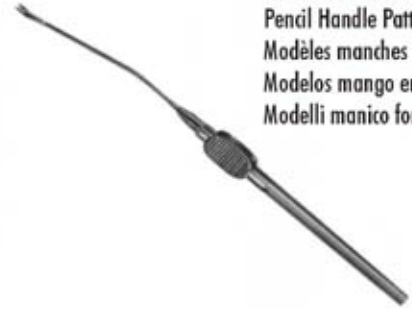

Modelle mit Bleistiftgriff  
Pencil Handle Patterns  
Modèles manches crayon  
Modelos mango en forma de lapiz  
Modelli manico forma matita

M44.550.00		M44.560.00
M44.551.00		M44.561.00
M44.553.00		M44.563.00
M44.554.00		M44.564.00
M44.555.00		M44.565.00
M44.556.00		
M44.557.00		M44.657.00
M44.559.00		M44.659.00
M44.560.00		M44.660.00
M44.561.00		
M44.562.00		M44.662.00
M44.563.00		M44.663.00
M44.565.00		M44.665.00
M44.567.00		M44.667.00
M44.586.00		M44.686.00
M44.587.00		M44.687.00
M44.588.00		M44.688.00
M44.589.00		M44.689.00

M44.650.00-M44.689.00  
micro . Mini  
BG

Otologie  
 Otology  
 Otologie  
 Otologia  
 Otologia



SCHUKNECHT  
 M44.701.01



SCHUKNECHT  
 M44.701.02



SCHUKNECHT  
 M44.703.15  
 15,5 cm



WULLSTEIN  
 M44.704.15  
 15 cm



TABB  
 M44.705.15  
 15 cm



PLESTER  
 M44.706.35  
 15 cm/3,5 mm Ø



ROSEN  
 M44.709.10-M44.709.30

M44.709.10  
 1,0 mm

M44.709.14  
 1,4 mm

M44.709.16  
 1,6 mm

M44.709.20  
 2,0 mm

M44.709.26  
 2,6 mm

M44.709.28  
 2,8 mm

M44.709.30  
 3,0 mm



BARBARA  
 M44.710.15



BARBARA  
 M711.15



BARBARA  
 M44.713.15



BARBARA  
 M44.715.15



mm  
 0,3  
 0,6  
 1,0  
 1,2  
 1,5  
 2,0  
 2,5

BARBARA  
 M44.702.03  
 M44.720.06  
 M44.720.10



BARBARA  
 M44.722.03  
 M44.722.06  
 M44.722.10  
 M44.722.12  
 M44.722.15  
 M44.722.20  
 M44.722.25



BARBARA  
 M44.724.03  
 M44.724.06  
 M44.724.10  
 M44.724.12  
 M44.724.15  
 M44.724.20  
 M44.724.25



BARBARA  
 M44.725.05 = 0,5 mm  
 M44.725.10 = 1,0 mm



M44.710.15-m44.725.10

Otologie  
Otology  
Otologie  
Otologia  
Otologia

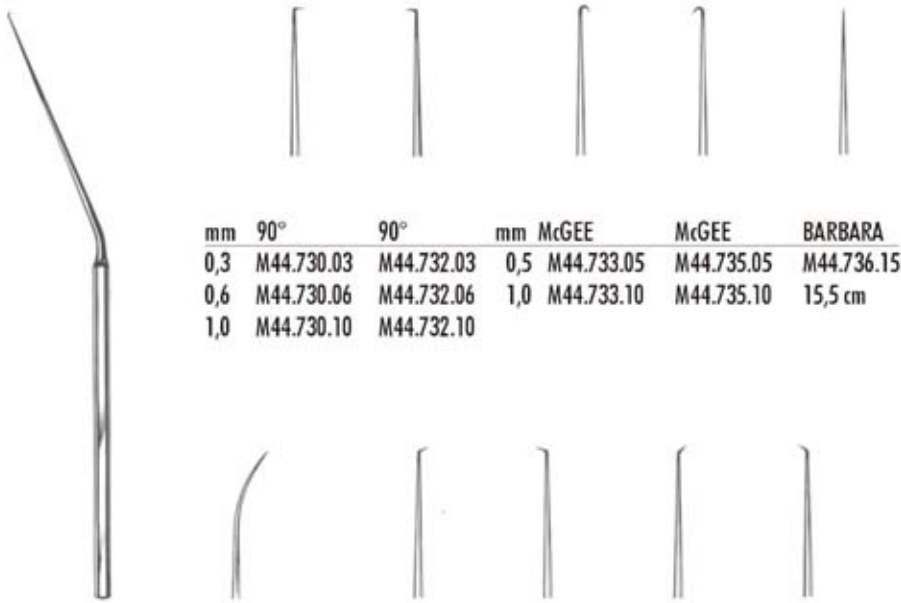

mm	90°	90°	mm	McGEE	McGEE	BARBARA
0,3	M44.730.03	M44.732.03	0,5	M44.733.05	M44.735.05	M44.736.15
0,6	M44.730.06	M44.732.06	1,0	M44.733.10	M44.735.10	15,5 cm
1,0	M44.730.10	M44.732.10				

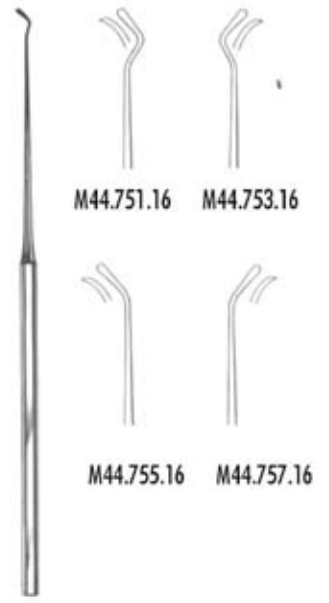

M44.751.16 M44.753.16  
M44.755.16 M44.757.16

ROSEN  
M44.737.15  
15,5 cm

mm	25°	25°	45°	45°
0,3	M44.741.03	M44.743.03	M44.745.03	M44.747.03
0,6	M44.741.03	M44.743.06	M44.745.06	M44.747.06
1,0	M44.741.03	M44.743.10	M44.745.10	M44.747.10

FISCH  
M44.751.16-M44.757.16

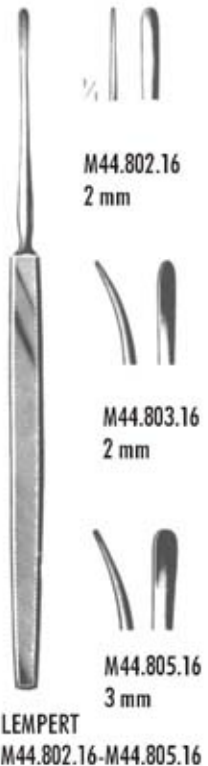

M44.802.16  
2 mm

M44.803.16  
2 mm

M44.805.16  
3 mm

LEMPERT  
M44.802.16-M44.805.16



1,0/1,2 mm M44.760.01  
1,5/1,8 mm M44.760.02

1,0/1,2 mm M44.762.01  
1,5/1,8 mm M44.762.02

HOUSE  
M44.760.01-M44.762.02

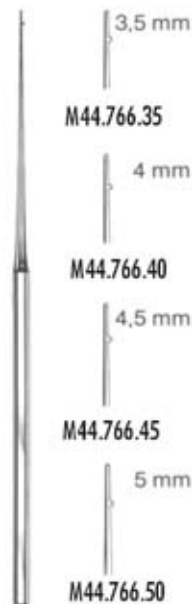

3,5 mm  
M44.766.35

4 mm  
M44.766.40

4,5 mm  
M44.766.45

5 mm  
M44.766.50

HOUSE  
M44.766.35-M44.766.50



LEMPERT  
M44.807.20

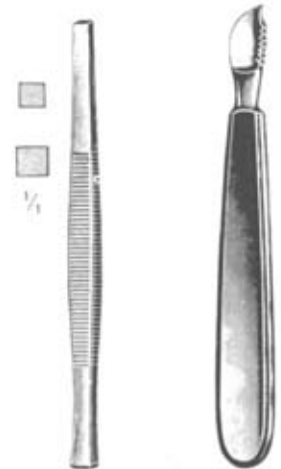

mm PASSOW  
2 x 2 M44.810.02  
3 x 3 M44.810.03

MUCK  
M44.812.13  
13 cm



Rhinologie  
Rhinology  
Rhinologie  
Rinologia  
Rinologia

Nsensespekula  
Nasal Specula  
Speculums nasaux  
Especulos Nasaes  
Specoli nasali

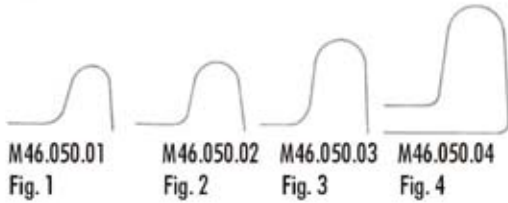

M46.050.01 Fig. 1  
M46.050.02 Fig. 2  
M46.050.03 Fig. 3  
M46.050.04 Fig. 4



THUDICHUM  
M46.050.01-M46.050.07

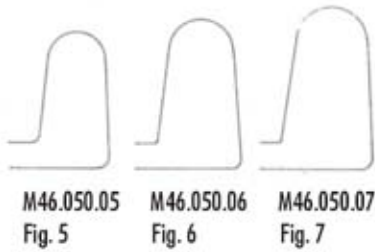

M46.050.05 Fig. 5  
M46.050.06 Fig. 6  
M46.050.07 Fig. 7



M46.060.01  
Fig. 1



M46.060.02  
Fig. 2



M46.060.03  
Fig. 3



VOLTOLINI  
M46.060.01-M46.060.03



M46.12.01  
Fig. 1

M46.102.02  
Fig. 2

M46.1k02.03  
Fig. 3

HARTMANN-HALLE  
M46.102.01-M46.102.03  
15 cm



Mod. Wien . Viena . Viene . Viena

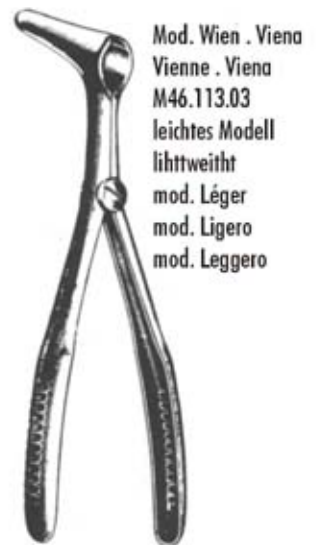

Mod. Wien . Viena  
Vienne . Viena  
M46.113.03  
leichtes Modell  
lihttweitht  
mod. Léger  
mod. Ligero  
mod. Leggero

Baby . Bébé M46.112.01  
Kind . Child . Enf. Nino . Bam M46.112.02  
Erw. Adult. M46.112.03

Rhinologie  
Rhinology  
Rhinologie  
Rinologia  
Rinologia

Nasenspekula  
Nasl Specula  
Speculums nasaux  
Especulos nasales  
Specoli nasali



TECK.-HALLE  
M46.116.13  
13,5 cm



KILLIAN  
M46.120.35-M46.120.90  
13 cm



M46.120.35  
35 mm

M46.120.50  
50 mm

M46.120.90  
75 mm

M46.120.90  
90 mm



COTTLE  
M46.124.35-M46.124.90  
14 cm



COTTLE  
M46.126.35-M46.126.90 schwarz . Black . Loirs . Negros . neri  
14 cm



M46.124.35  
M46.126.35

M46.124.50  
M46.136.50

M46.124.75  
M46.126.75

M46.124.90  
M46.126.90

Rhinologie  
Rhinology  
Rhinologie  
Rinologia  
Rinologia



**YANKAUER**  
M46.131.19  
19 cm



**MICHEL**  
M46.139.12-M46.139.18  
25 cm



M46.139.12  
12 mm



M46.139.14  
14 mm



M46.139.16  
16 mm



M46.139.18  
18 mm



**TROELTSCH**  
M46.151.15  
15 cm



**TROELTSCH**  
M46.151.18  
18 cm



**JANSEN**  
M46.154.20  
20 cm

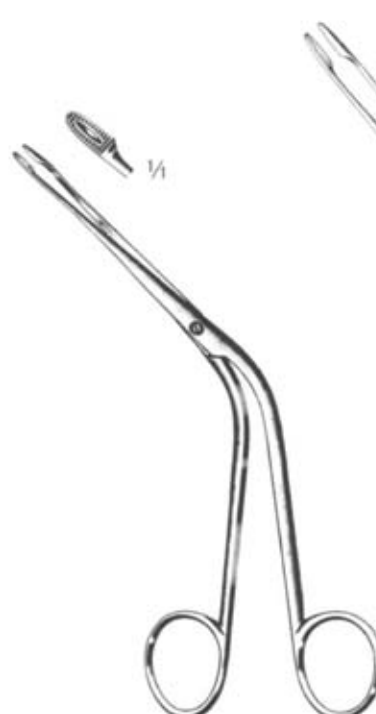

**HARTMANN**  
M46.161.16  
16 cm

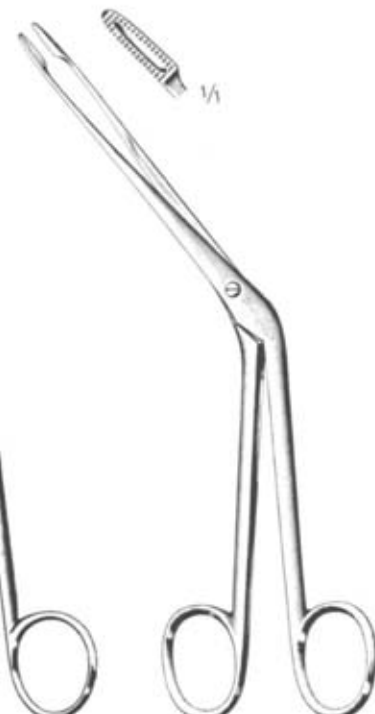

**HARTMANN**  
M46.161.20  
20 cm

Rhinologie  
Rhinology  
Rhinologie  
Rinologia  
Rinologia

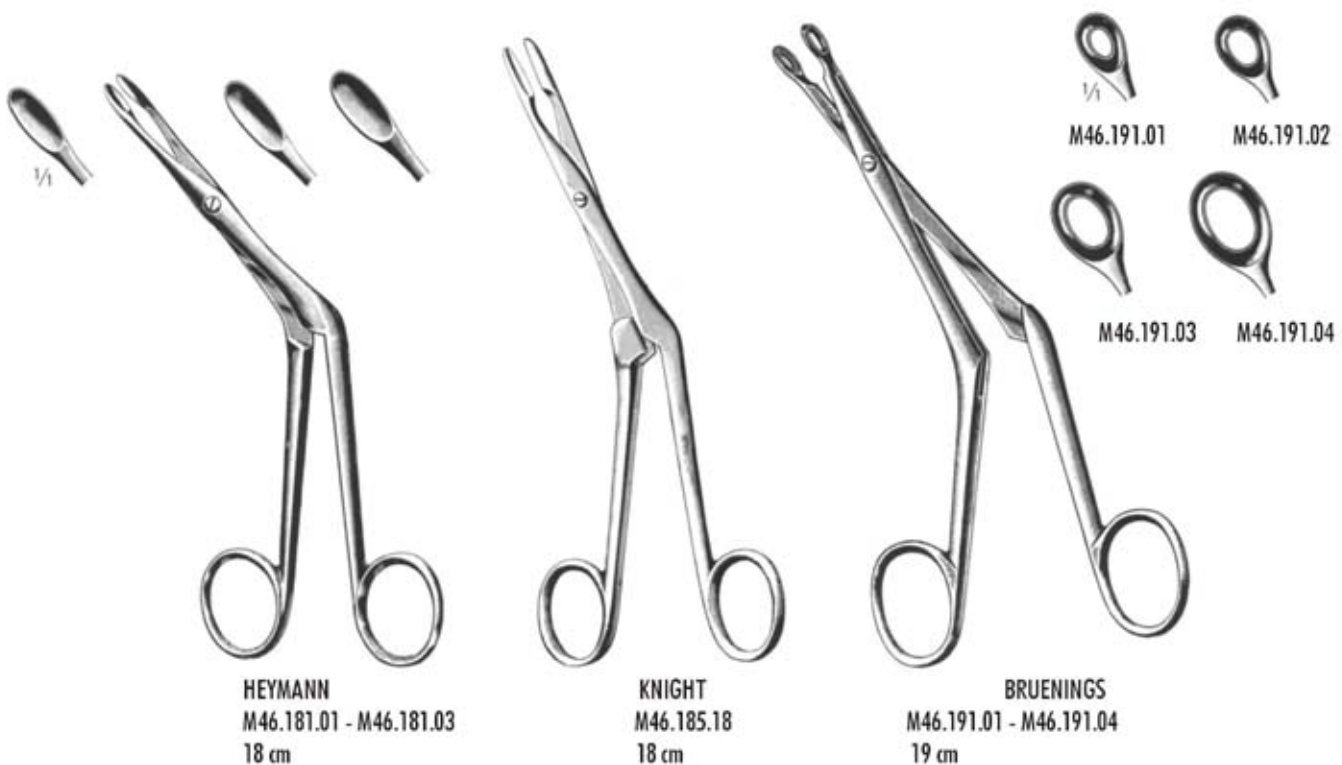
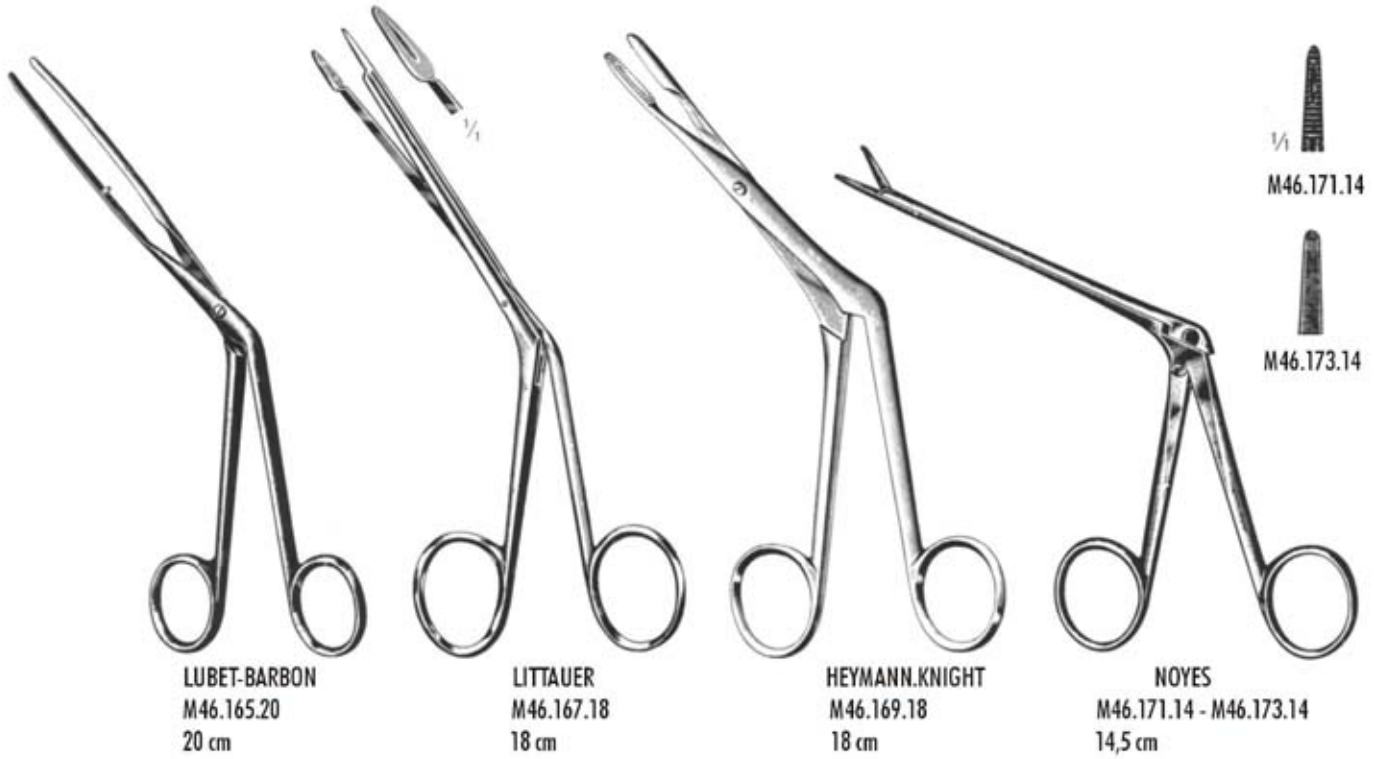

Rhinologie  
Rhinology  
Rhinologie  
Rinologia  
Rinologia

Scharfe Nasenzangen  
Nasal Cutting Forceps  
Pincès coupantes nasales  
Pinzas cortantes nasales  
Pinte taglianti nasali

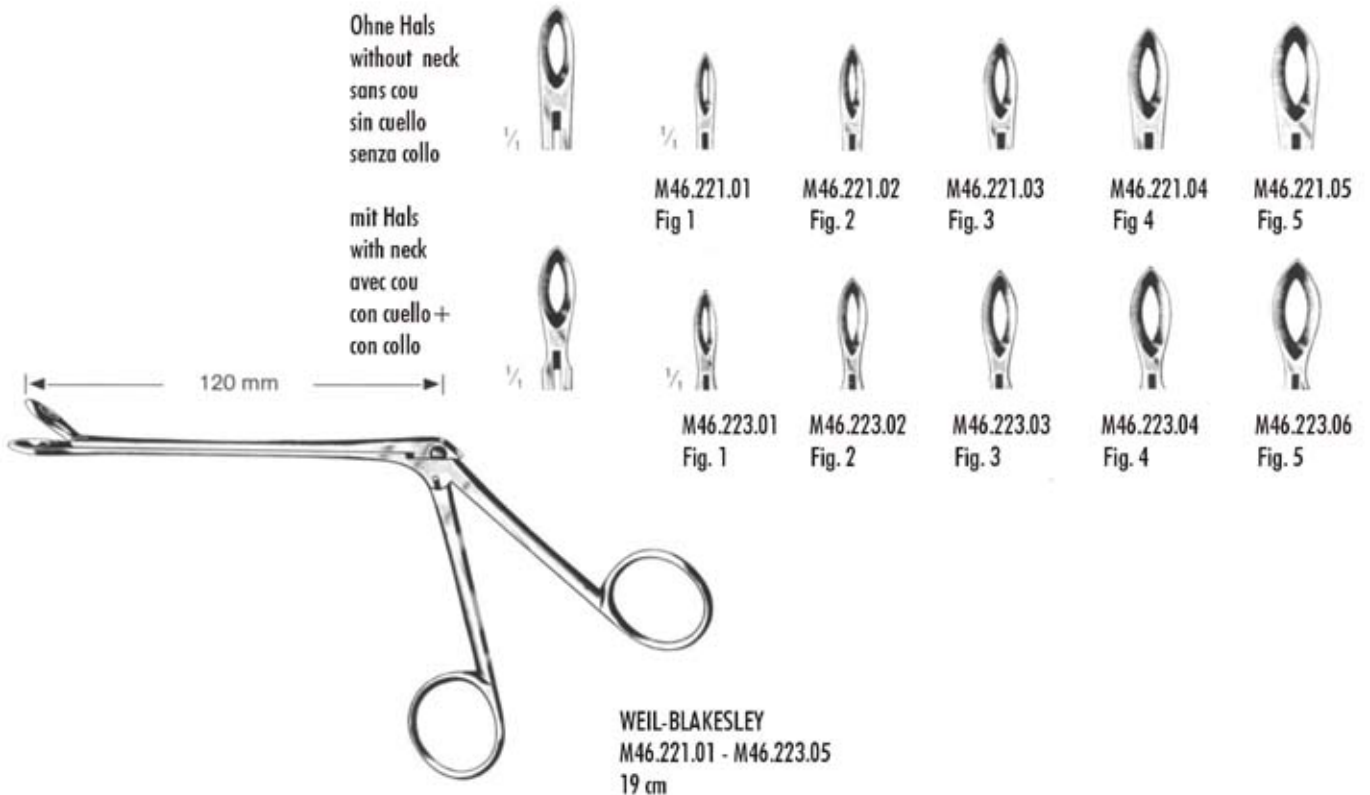

Scharfe Nasenzangen  
Nasal Cutting Forceps  
Pincès coupantes nasales  
Pinzas cortantes nasales  
Pinze taglienti nasali

Rhinologie  
Rhinology  
Rhinologie  
Rinologia  
Rinologia



M46.231.01 - M46.237.03  
19 cm



RUBIN  
M46.251.21  
21 cm

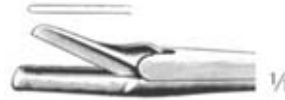

Septum-Quetschzange  
Setum Crushing Forceps  
PINCE à écraser la cloison  
Pinza para magullar tabique  
Pinza per ammaccare il setto



STRUYCKEN  
M46.231.01  
Fig. 1



STRUYCKEN  
M46.231.k02  
Fig. 2

-  M46.237.01  
5 mm
-  M46.337.02  
7 mm
-  M46.237.03  
9 mm



MYLES

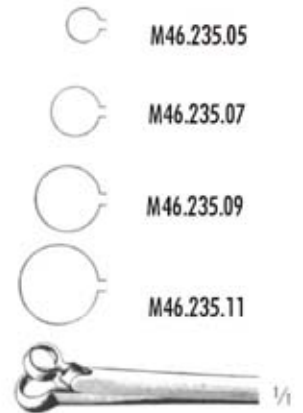

HARTMANN

Rhinologie  
 Rhinology  
 Rhinologie  
 Rinologia  
 Rinologia



mm x mm    KERRISON  
 3 x 3    M46.303.03  
 4 x 4    M46.303.04  
 5 x 5    M46.303.05  
 6 x 6    M46.3k03.05  
 17 cm

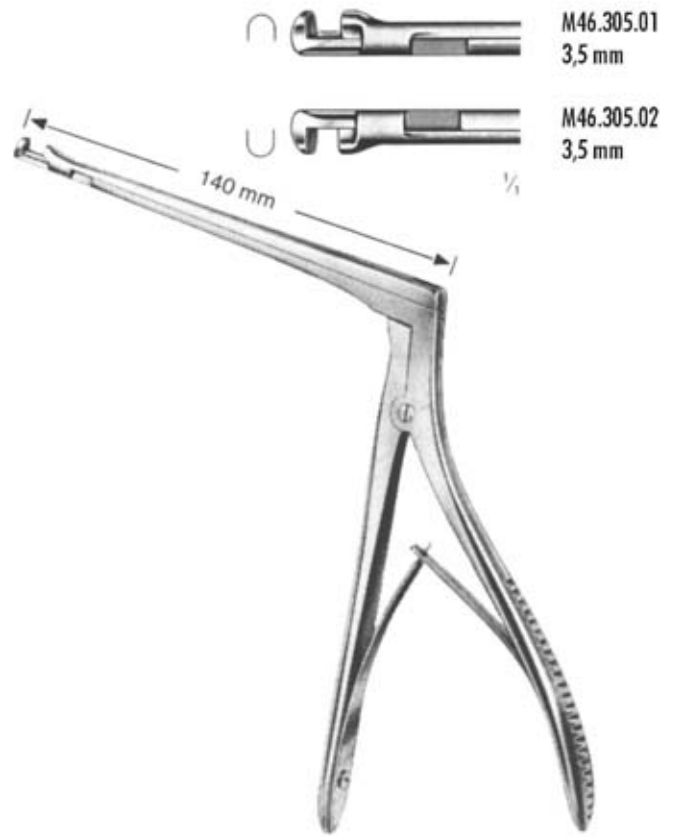

HAJEK-KOFLER  
 M46.305.01- M46.305.02



mm    CITELLI  
 1,0    M46.311.10  
 2,5    M46.311.25  
 4,0    M46.311.40



BEYER  
 M46.315.20  
 2,0 mm



HAJEK - CLAUS  
 M46.320.02  
 20 cm

Rhinologie  
Rhinology  
Rhinologie  
Rinologia  
Rinologia



MIDDLETON-JANSEN  
M46.323.19  
19 cm



MIDDLETON-JANSEN  
M46.325.19  
19 cm



∅ mm LICHTWITZ  
1,5 M46.340.15  
1,8 M46.340.18  
2,0 M46.340.20  
Luer-Loch  
10 cm



KILLIAN  
M46.341.03  
14 cm/3 mm ∅



KRAUSE  
M46.351.26  
26 cm



WILDE  
M46.352.24  
24 cm



M46.355.  
0,3 mm



Rhinologie  
Rhinology  
Rhinologie  
Rinologia  
Rinologia

Nasenmesser  
Nasal Knives  
Bistouris nasux  
Bisturies nasales  
Coltelli nasali

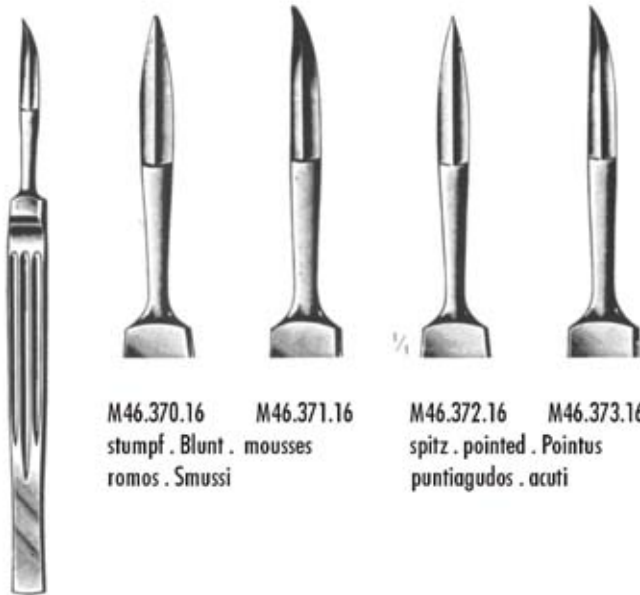

M46.370.16 M46.371.16 M46.372.16 M46.373.16  
stumpf . Blunt . mousses spitz . pointed . Pointus  
romos . Smussi puntiagudos . acuti

JOSEPH  
M46.370.16 - M46.373.16



PREER  
M46.374.15  
15 cm



PREER  
M46.375.19  
19 cm

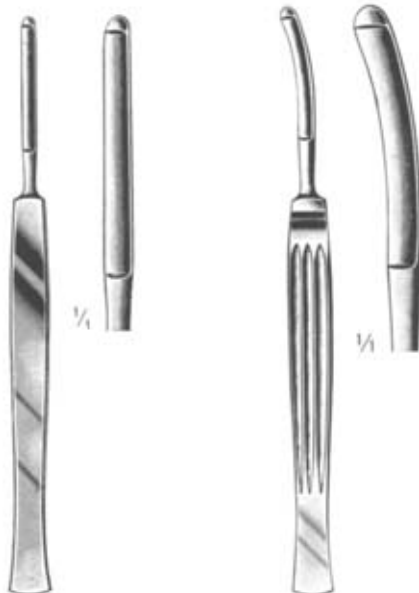

JOSEPH  
M46.376.16  
16 cm



COMVERSE  
M46.379.16  
16 cm



COTTLE  
M46.380.15  
15 cm



M46.382.15



COTTLE  
M46.384.15



M46.385.15

Septum - Messer  
Septum Knives  
Couteaux pour la cloison  
Cuchillos para tabique  
Coltelli per setto

Rhinologie  
Rhinology  
Rhinologie  
Rinologia  
Rinologia

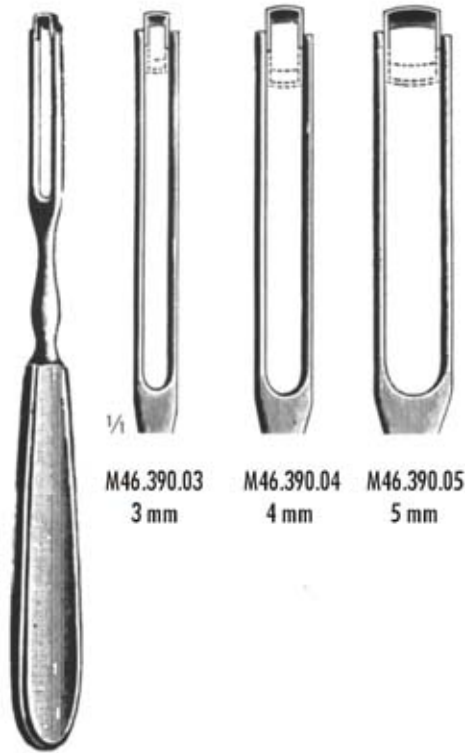

M46.390.03 3 mm  
M46.390.04 4 mm  
M46.390.05 5 mm

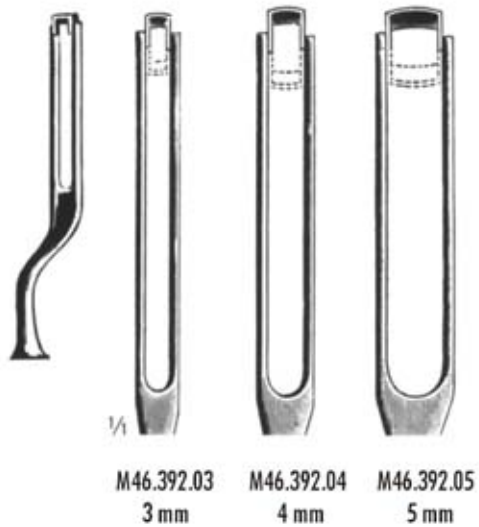

M46.392.03 3 mm  
M46.392.04 4 mm  
M46.392.05 5 mm



BRUENINGS  
M46.398.16  
16,5 cm

BALLENGER  
M46.390.03-M46.392.05  
20 cm

Septum - Elevatorien  
Septum Elevators  
Elevateurs pou la cloison nasale  
Elevadores para tabique  
Elevatori per setto

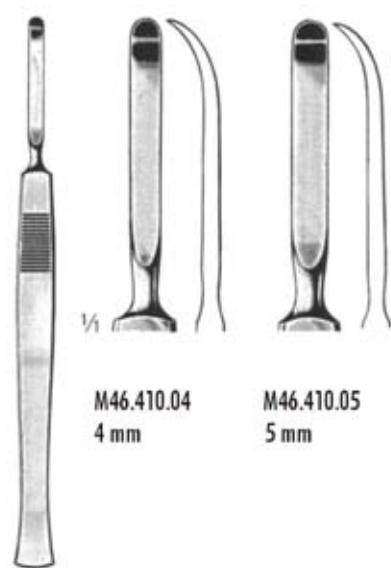

M46.410.04 4 mm  
M46.410.05 5 mm

McKENTY  
M46.410.04-M46.410.05  
15 cm



ROGER  
M46.413.19  
19 cm

FREER  
M46.415.18  
18 cm

FREER  
M46.417.19  
19 cm

FREER  
M46.419.19  
19 cm

Rhinologie  
Rhinology  
Rhinologie  
Rinologia  
Rinologia



COTTLE  
M46.421.23  
23 cm



COTTLE  
M46.423.22  
22 cm



JOSEPH  
M46.425.16  
16 cm



COTTLE  
M46.425.19  
19 cm



KILLIAN  
M46.426.22  
22 cm



HAJEK-BALLENGER  
M46.428.21  
22 cm



BALLENGER  
M46.430.22  
22 cm



FREER  
M46.450.04  
4 mm



FREER  
M46.451.04  
4 mm

Rhinologie  
Rhinology  
Rhinologie  
Rinologia  
Rinologia

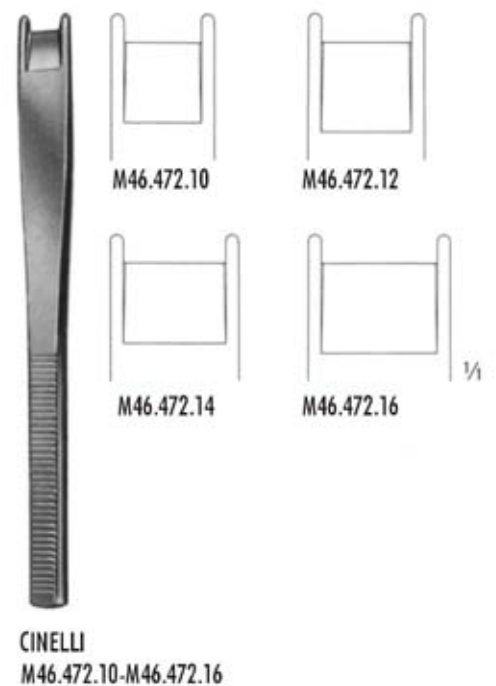
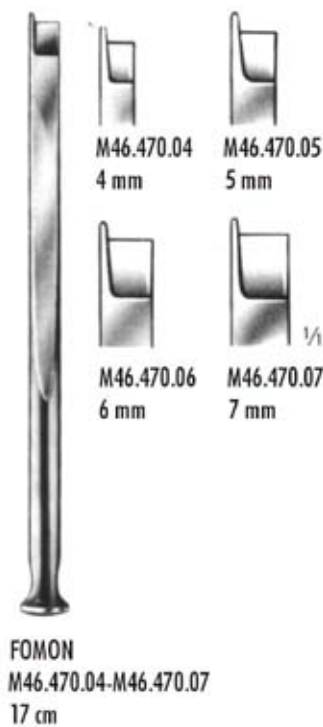
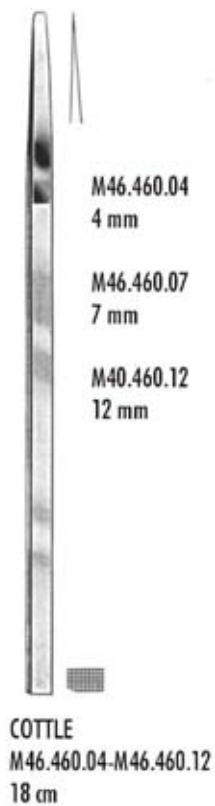
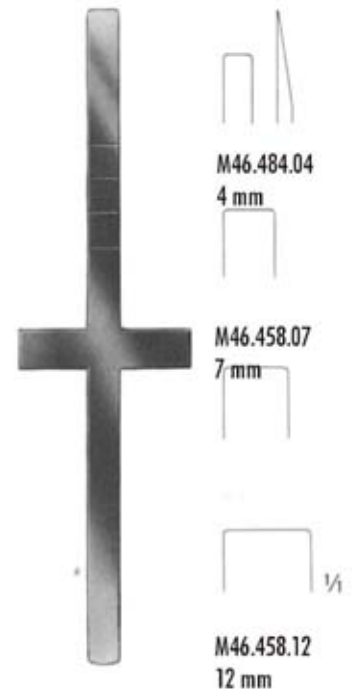
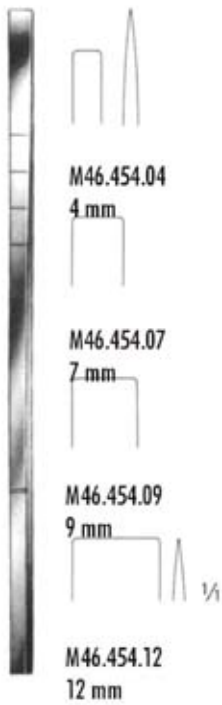

Rhinologie  
 Rhinology  
 Rhinologie  
 Rinologia  
 Rinologia

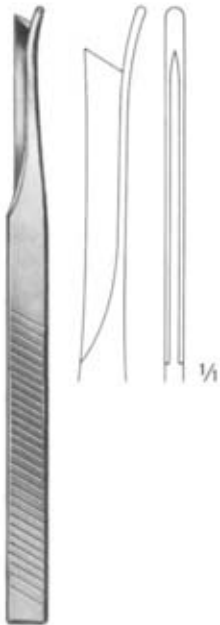

SILVER  
 M46.473.0k1  
 18 cm

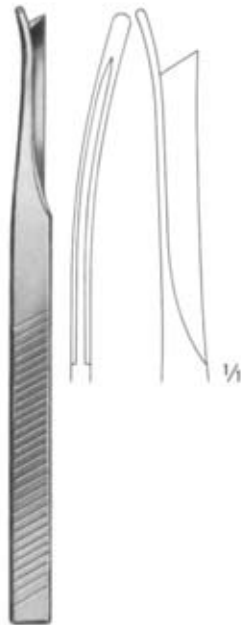

SILVER  
 M46.473.02  
 18 cm

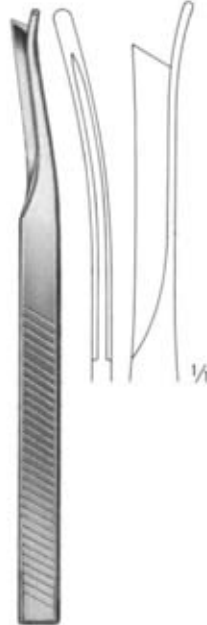

SILVER  
 M46.473.03  
 18 cm



KILLIAN-CLAUS  
 M46.482.05  
 17 cm/5 mm



mm	HAJEK
4	M46.484.04
6	M46.484.06
8	M46.484.08



WEST  
 M46.486.16  
 16 cm



WEST  
 M46.487.16  
 16 cm



FREER  
 M46.489.16  
 6 mm



JOSEPH  
 M46.502.16  
 16 cm

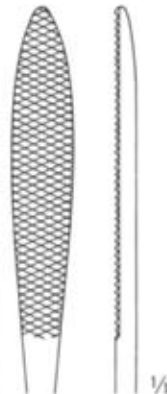

AUFRICHT  
 M46.504.18  
 18 cm

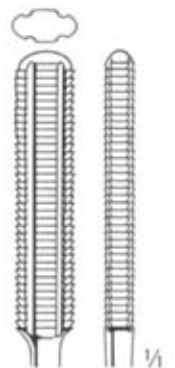

Rhinologie  
Rhinology  
Rhinologie  
Rinologia  
Rinologia



M46.507.18



m46.507.19

LEWIS  
M46.407.18-M46.507.19  
18 cm



M46.511.21

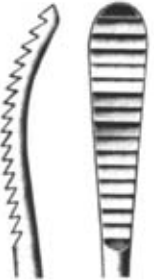

M46.513.21

WIENER  
M46.511.21-M46.513.21  
21 cm



M46.514.16  
fein . Fine



M46.516.16  
grob . Coarse . Gruesa  
dentellure groBe  
dentellatura grossa

JOSEPH (LEWIS)  
M46.714.16-M46.516.16  
18 cm

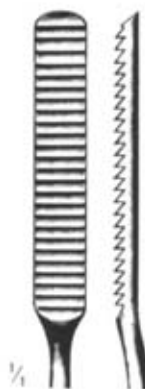

MALTZ (COTTLE)  
M46.518.21  
21 cm



FOMON  
M46.520.21  
21 cm

Rhinologie  
Rhinology  
Rhinologie  
Rinología  
Rinologia

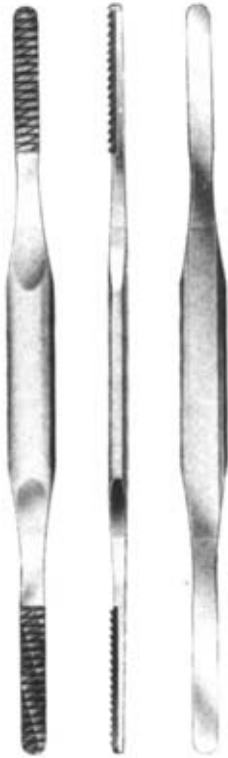

FOMON  
20 cm TC

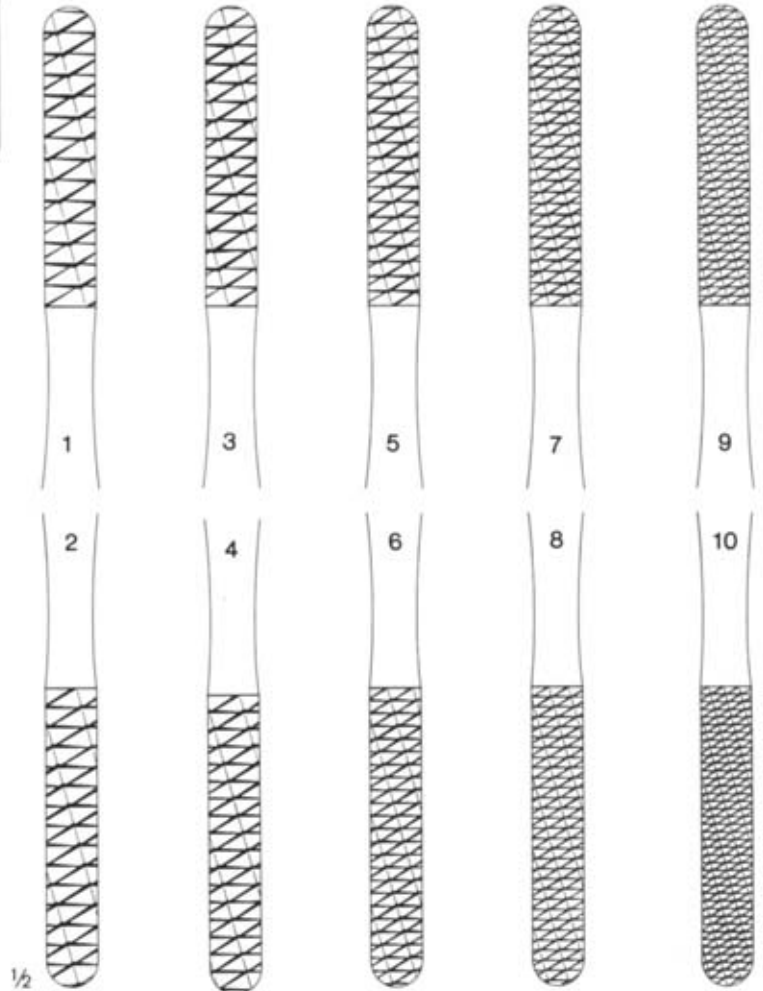

Fig. 1/2  
M46.522.01

Fig. 3/4  
M46.522.05

Fig. 5/6  
M46.522.05

Fig. 7/8  
M46.522.07

Fig. 9/10  
M46.522.09

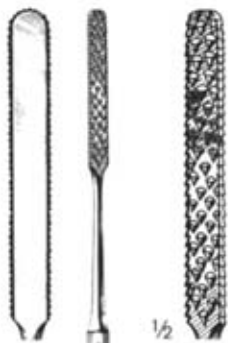

GALLAHER M46.526.16



M46.527.16

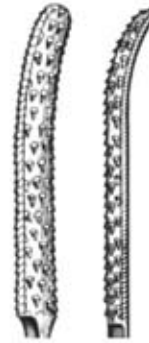

M46.529.16

1/2  
Fig. 1

Fig. 2

Fig. 3

Rhinologie  
Rhinology  
Rhinologie  
Rinologia  
Rinologia

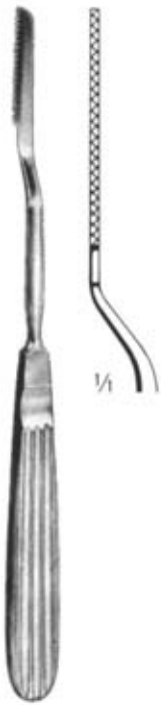

**JOSEPH**  
19 cm M46.532.19  
links . Left  
à gauche  
izquierda  
a sinistra



M46.534.19  
rechts . Right .  
à droite  
derecha  
a destra



**JOSEPH**  
M46.535.01 17 cm M46.535.02



**AUFRICHT**  
M46.551.16



**COTTLE**  
M46.556.14



**FOMON**  
M46.556.16



**FOMON**  
M46.557.17



**COTTLE-NEIVERT**  
M46.559.20



**GILLIES**  
Fig. 1 M46.560.18  
Fig. 2 M46.562.18  
18 cm



Rhinologie  
Rhinology  
Rhinologie  
Rinología  
Rinologia



ASCH  
M46.571.23  
23 cm



WALSHAM  
M46.572.23-m46.575.23  
23 cm



M46.572.23  
gerade  
straight  
droite  
recta  
retta



M46.573.23  
links  
left  
à gauche  
izquierda  
a sinistra



M46.575.23  
rechts  
right  
à droite  
derecha  
a destra



JATHKO  
M46.595.15



FAULKNER  
M46.601.21  
21 cm



COAKLEY  
M46.607.01-M46.607.06  
17 cm



M46.607.01  
Fig. 1



M46.607.04  
Fig. 1



M46.607.02  
Fig. 2



M46.607.05  
Fig. 2



M46.607.03  
Fig. 3



M46.607.06  
Fig. 3

Rhinologie  
Rhinology  
Rhinologie  
Rinologia  
Rinologia



M46.620.01  
Fig. 1



M46.620.02  
Fig. 2



M46.620.03  
Fig. 3



M46.620.06  
Fig. 3



M46.620.05  
Fig. 5



M46.620.06  
Fig. 6

BECKMANN  
M46.620.01-M46.620.06  
22 cm



M46.630.01  
Fig. 1



M46.630.02  
Fig. 2



M46.630.03  
Fig. 3



M46.630.04  
Fig. 4

BARNHILL  
M46.630.01-M46.630.04  
21 cm



M46.641.01  
Fig. 1

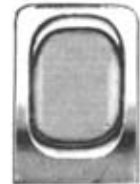

M46.641.02  
Fig. 2



M46.641.01  
Fig. 3

Ersatzklingen, gelocht  
Spare blades, perforated  
Lames de rechange, perforées  
Hojas de repuesto, perforadas  
Lame di ricambio, forate

Fig.  
1 M46.642.01  
2 M46.642.02  
3 M46.642.03



M46.620.05  
Fig. 5



M46.620.06  
Fig. 6



M46.636.03  
Fig. 3



M46.636.04  
Fig. 4

St. CLAIR-THOMSON  
M46.641.01-M46.641.03  
21 cm

LAFORCE  
M46.636.01-M46.636.04  
25 cm

Mund und Zunge  
 Mouth and Tongue  
 Bouche et langue  
 Boca y lengua  
 Bocca e lingua

Zungenspatel, Lippenhalter  
 Tonque Depressors, Lip Retractors  
 Abaisse-langue, écarteurs des lèvres  
 Abajalenqua, Sepradores de labios  
 Abbassalingua, Divaricari di labbra



M48.102.16  
 16 cm  
 Holz . Wood  
 bois . Madera . Leggno



FRENZEL  
 M48.105.16  
 16,5 cm



BRUENINGS  
 M48.107.19  
 19 cm



BUCHWALD  
 M48.109.19  
 19 cm



HARTMANN  
 M48.111.15  
 15 cm



M48.115.05

M48.115.02

WIEDER  
 M48.115.01-M48.115.02



ANDREW  
 M48.117.11  
 11 cm



TOBOLD  
 M48.119.14  
 14,5 cm



cm STERBERG  
 M48.227.14  
 M48.227.16  
 M48.227.18



cm STERNBERG  
 M48.229.12  
 M48.229.14  
 M48.229.16

Mund und Zunge  
 Mouth and Tongue  
 Bouche et langue  
 Boca y lengua  
 Bocca e lingua



M48.230.11  
 11 cm



M48.235.19  
 19 cm



cm COLLIN  
 16 M48.250.16  
 18 M48.250.18



M48.255.99  
 Ersatz (Paar)  
 Spare (Pair)  
 Rechange (Paire)  
 Repusto (pareja)  
 Ricambio (coppia)

YOUNG  
 M48.255.16  
 16 cm

Mundsperrer . Mouth Gags  
 Ouvre-bouche . Abrebocas  
 Apribocca



DOYEN-JANSEN (MOLT)  
 M48.265.12  
 12 cm



DOYEN-JANSEN (MOLT)  
 M48.265.14  
 14 cm



DENHART  
 M48.267.12  
 12 cm



ROSER-KOENIG  
 M48.270.16  
 M48.270.19



HEISTER  
 M48.272.13  
 13 cm

Mund und Zunge  
 Mouth and Tongue  
 Bouche et langue  
 Boca y lengua  
 Bocca e lingua

Mundspenrrer . Mouth Gags  
 Ouvre-bouche . Abrebocas  
 Apricocca



cm JENNINGS  
 9 M48.274.09  
 13 M48.274.11  
 15 M48.274.15



cm WHITEHEAD  
 11 M48.280.13  
 13 M48.280.13  
 15 M48.280.15

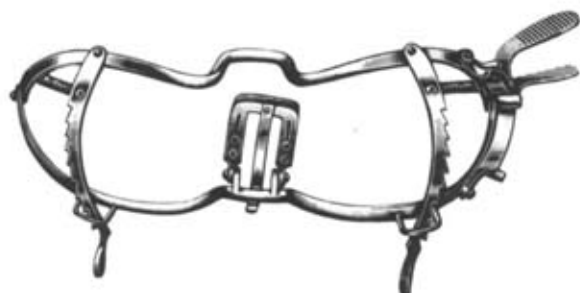

cm WHITEHEAD  
 11 M48.281.11  
 13 M48.281.13  
 15 M48.281.15



cm SEEMANN-SEIFFERT  
 9 M48.285.09  
 11 M48.285.11  
 13 M48.285.13  
 15 M48.285.15



M48.310.10



M48.310.01  
 27 x 105 mm Fig. 1

DAVIS-BOYLE  
 M48.310.00  
 compl.



M48.310.02  
 25 x 90 mm Fig. 2



M48.310.03  
 25 x 75 mm Fig. 3



M48.310.04  
 22 x 60 mm Fig. 4



M48.310.05  
 20 x 25 mm Fig. 5

Mundsperrer  
Mouth Gags  
Ouvre-bouche  
Abrebocas  
Apribocca

Mund und Zunge  
Mouth and Tongue  
Bouche et langue  
Boca y lengua  
Bocca e lingua



M48.315.10



1/2  
M48.315.01  
Fig. 1



M48.315.02  
Fig. 2



M48.315.03  
Fig. 3



KILNER-DOUGHTY  
M48.315.00  
compl.



M48.320.10

McVOR  
M48.320.00  
compl.



M48.320.01  
27 x 95 mm  
Fig. 1



1/2  
M48.320.02  
22 x 85 mm  
Fig. 2



M48.320.03  
22 x 70 mm  
Fig. 3

Mund  
Mouth  
Bouche  
Boca  
Bocca



MAUNDER  
M48.360.10



PITHA  
M48.365.10



M48.371.01  
Fig. 1

LANGENBECK  
M48.371.02  
Fig. 2

M48.371.03  
Fig. 3



Links  
left side  
côté gauche  
izquierda  
lato sinistro

Rechts  
right side  
côté droit  
derecha  
lato destro

cm  
22,5  
23,5  
24,0

ROWE  
M48.501.22  
M48.501.23  
M48.501.24

ROWE  
M48.503.22  
M48.503.23  
M48.503.24

Säugling . Baby . Bébé . Lattante  
Kinder . Child . Enfant . Nino . Bambino  
Erwachsene . Adult

Tonsillen  
Tonsils  
Amygdales  
Amigdalas  
Tonsille



cm LOVE  
18 M50.103.18  
20 M50.103.20  
22 M50103.22



HOFER  
M50.109.24  
24 cm



NAGER  
M50.111.23  
23 cm



HURD  
M50.131.22  
glatt . Smooth . Lisse  
22 cm  
M50.133.22  
gezahnt . Serrated  
dentele . Dentado  
dentellato  
22 cm



HENKE  
M50.135.23  
23 cm

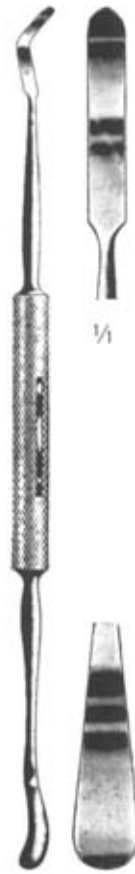

CARPENTER  
M50.139.25  
25 cm



CARPENTER  
M50.143.24  
24 cm



LUNIATSCHEK  
M50.151.19  
19 cm



Tonsillen  
Tonsils  
Amygdales  
Amigdalas  
Tonsille



DUPUY-WEISS  
M5k0.165.22 M50.167.22

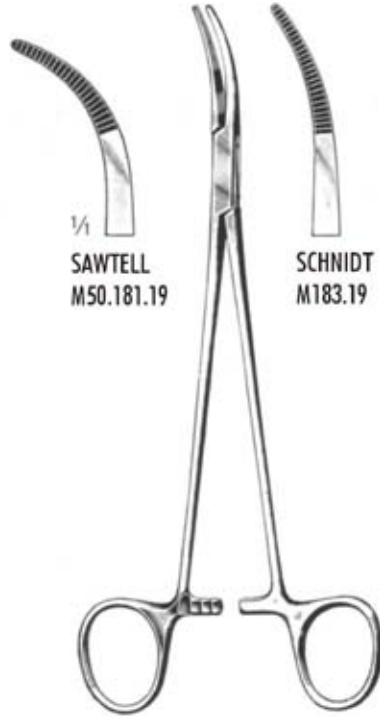

1/1  
SAWTELL  
M50.181.19

SCHNIDT  
M183.19

M50.181.19-M50.183.19  
19 cm

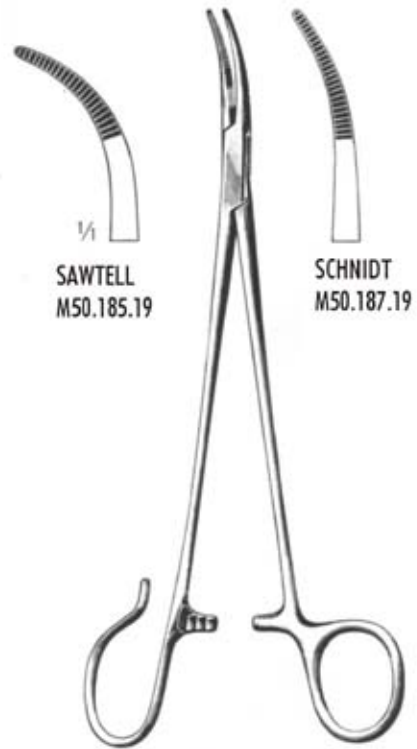

1/1  
SAWTELL  
M50.185.19

SCHNIDT  
M50.187.19

M50.185.19-M50.187.19  
19 cm

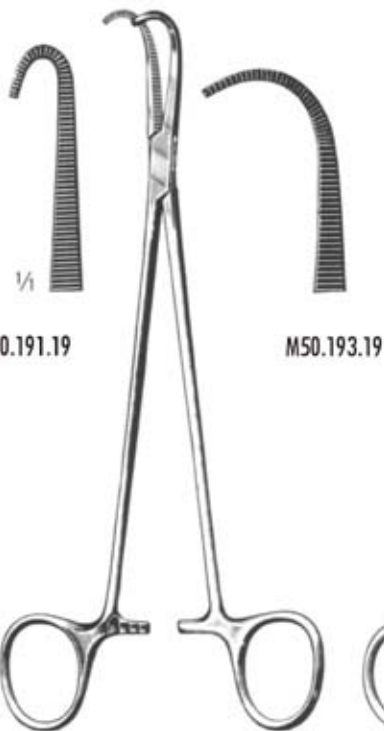

1/1  
M50.191.19

M50.193.19

NEGUS  
M50.191.19-M50.193.19  
19 cm



1/1  
M50.202.19

M50.203.19

COLVER  
M50.202.19-M50.203.19  
19 cm



cm WHITE  
18 M50.205.18  
23 M50.205.23

Tonsillen  
Tonsils  
Amygdales  
Amígdalas  
Tonsille



**BALLENGER**  
M50.207.21  
21,5 cm



**BLOHMKE**  
M50.209.20  
20 cm

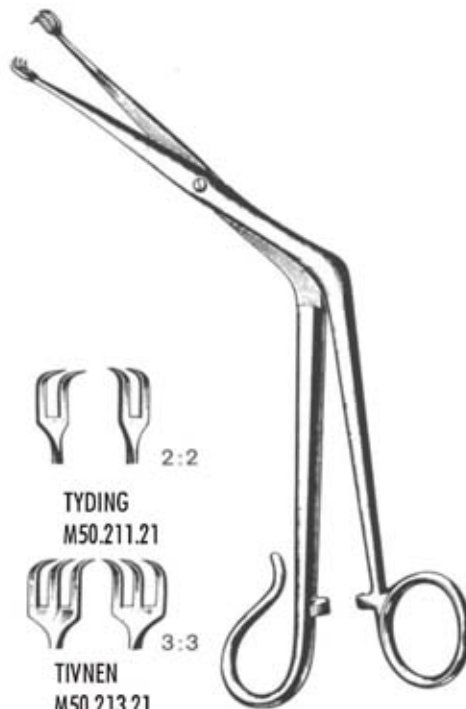

**TYDING**  
M50.211.21

**TIVNEN**  
M50.213.21

M50.211.21-M50.213.21  
21 cm



**MARSCHIK**  
M50.219.22  
22 cm



**CORWIN**  
M50.231.14  
14 cm



**EVES**  
M50.250.28  
28 cm



**EVES**  
M50.252.28  
28 cm



**BREUENINGS**  
M50.256.28  
28 cm



mm  
40 M50.257.40  
50 M50.257.50  
100 x



M50.259.03  
0,3 mm  
12 x

Tonsillen  
Tonsils  
Amygdales  
Amigdalas  
Tonsille

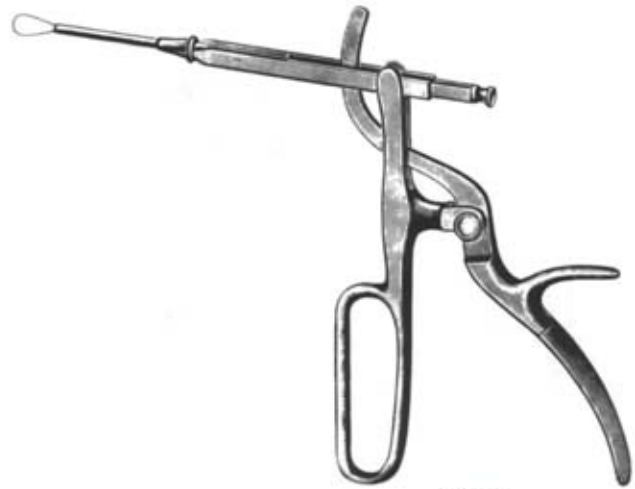

**TYDING**  
M50.260.00  
mit 1 geraden Aufsatz  
with straight tip  
à 1 embout droit  
con 1 punta recta  
con 1 punta retta

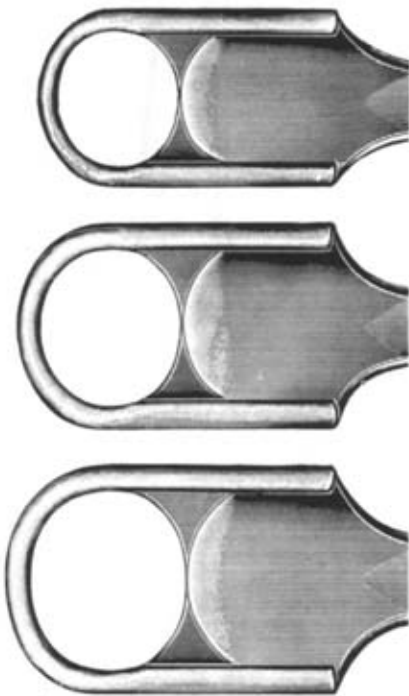

1/4



**ALUDER-BALLENGER**  
M50.270.00  
mit 3 Aufsätzen  
with 3 blades  
avec 3 lames  
con 3 hojas  
con 3 lame

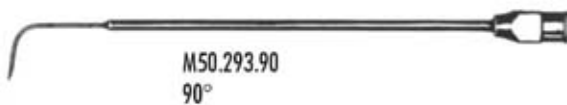
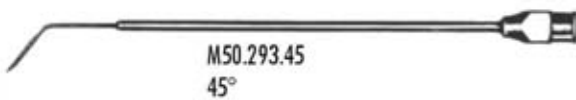
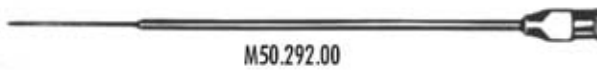

2 ml	M50.290.02
5	M50.290.05
10	M50.290.10

Kehlkopf  
Larynx  
Larynx  
Larynx  
Larynx



M52.101.22



M52.103.22



JACKSON  
M52.101.22-M52.103.22  
22 cm

FRAENKEL  
M52.111.18  
18 cm

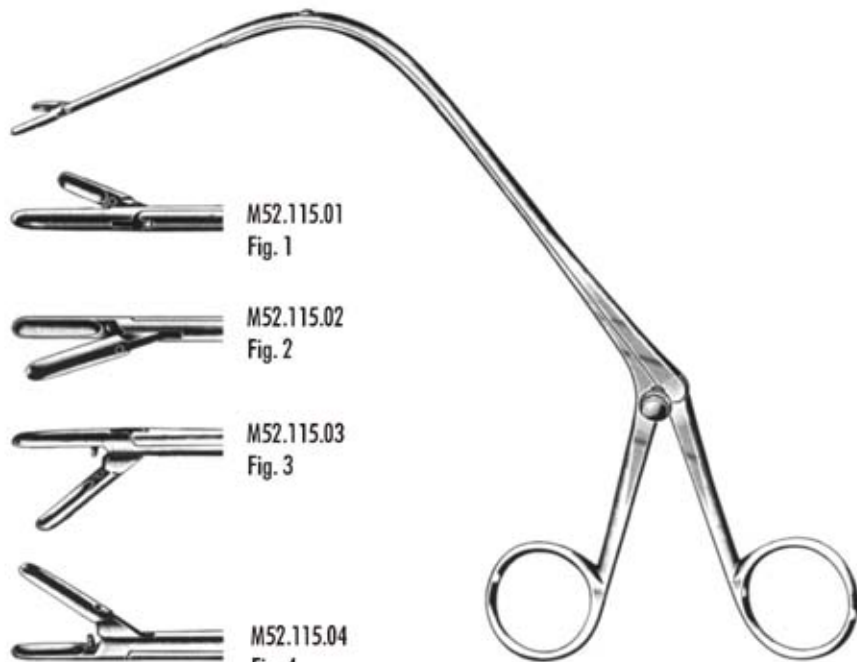

M52.115.01  
Fig. 1

M52.115.02  
Fig. 2

M52.115.03  
Fig. 3

M52.115.04  
Fig. 4

JURASZ  
M52.115.01-M52.115.04  
23 cm



REICHERT  
M52.121.24  
24 cm

Kehlkopf  
Larynx  
Larynx  
Larynx  
Larynx



HUBER  
M52.130.00



cm	BRUENINGS
20	M52.132.20
30	M52.132.30
40	M52.132.40
50	M52.132.50
60	M52.132.60



BRUENINGS  
M52.131.20



FRAENKEL  
M52.150.00



SEIFFERT  
M52.152.00



FRAENKEL  
M52.154.00



SCHEINMANN  
M52.155.00



SCHEINMANN  
M52.157.00

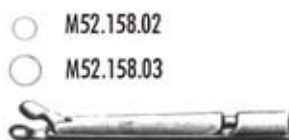

M52.158.02  
M52.158.03  
BRUENINGS  
M52.158.02-M52.158.03

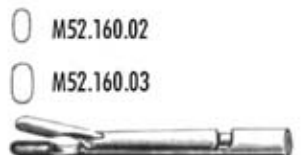

M52.160.02  
M52.160.03  
BRUENINGS  
M52.160.02-M52.160.03



LANGE  
M52.162.00

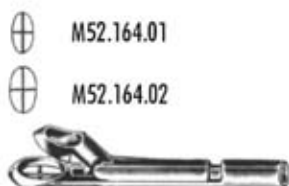

M52.164.01  
M52.164.02  
KRAUSE  
M52.164.01-M52.164.02



KRAUSE  
M52.166.00

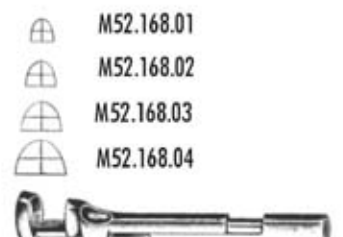

M52.168.01  
M52.168.02  
M52.168.03  
M52.168.04  
CORDES  
M52.168.01-M52.168.04



SCHUMACHER  
M52.170.00



M52.172.01  
M52.172.02  
CORDES  
M52.172.01-M52.172.02



CORDES  
M52.174.00



ROSENBERG  
M52.176.00

Kehlkopf  
Larynx  
Larynx  
Laringe  
Laringe

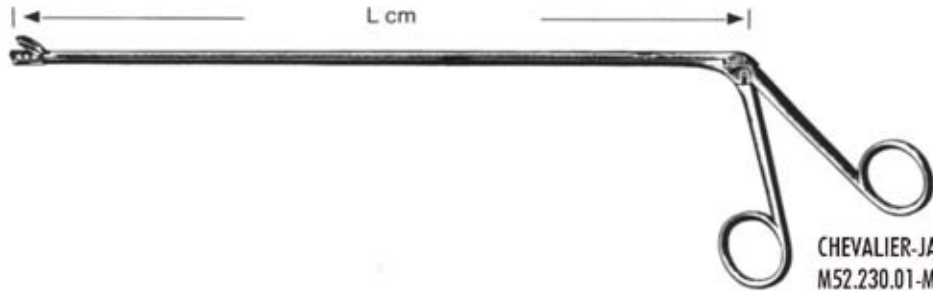

CHEVALIER-JACKSON  
M52.230.01-M52.260.07

cm	Fig. 1	Fig. 2	Fig. 3	Fig. 4	Fig. 5	Fig. 6	Fig. 7
30	M52.230.01	M52.230.02	M52.230.03	M52.230.04	M52.230.05	M52.230.06	M52.230.07
40	M52.240.01	M52.240.02	M52.240.03	M52.240.04	M52.240.05	M52.240.06	M52.240.07
50	M52.250.01	M52.250.02	M52.250.03	M52.250.04	M52.250.05	M52.250.06	M52.250.07
60	M52.260.01	M52.260.02	M52.260.03	M52.260.04	M52.260.05	M52.260.06	M52.260.07

M52.270.08-M52.270.30	Fig.	mm	M52.272.08-M52.272.30	M52.274.12	M52.276.10
M52.270.08	00	8	M52.272.08		
M52.270.08	0	10	M52.272.10		
M52.270.08	1	12	M52.272.12		
M52.270.14	2	14	M52.272.14		
M52.270.16	3	16	M52.272.16		
M52.270.18	4	18	M52.272.18		
M52.270.20	5	20	M52.272.20		
M52.270.22	6	22	M52.272.22		
M52.270.24	7	24	M52.272.24		
M52.270.26	8	26	M52.272.26		
M52.270.28	9	28	M52.272.28		
M52.270.08	10	30	M52.272.30		

Gastroskopie  
Gastroscoopy  
Gastroscopie  
Gastroscopía  
Gastroscopia

Flexible Zangen  
Flexible Forceps  
Pincas flexibles  
Pinzas flexibles  
Pinze flessibili



Ø 1,8 mm

Ø 2,2 mm

Ø 2,6 mm

Ø 3,4 mm



L cm

160	M53.110.16
160	M53.110.26
230	M53.110.23
230	M53.110.33



M53.120.16
M53.120.26
M53.120.23
M53.120.33



M53.130.16
M53.130.23



M53.140.16
M53.140.23



L cm

160	M53.111.16
160	M53.111.26
230	M53.111.23
230	M53.111.33



M53.121.16
M53.121.26
M53.121.23
M53.121.33



M53.131.16
M53.131.23



M53.141.16
M53.141.23



L cm

160	M53.112.16
160	M53.112.26
230	M53.112.23
230	M53.112.33



M53.122.16
M53.122.26
M53.122.23
M53.122.33



M53.142.16
M53.142.23



L cm

160	M53.113.16
160	M53.113.26
230	M53.113.23
230	M53.113.33



M53.123.16
M53.123.26
M53.123.23
M53.123.33



M53.143.16
M53.143.23

Flexible Zangen, isoliert  
Flexible Forceps, insulated  
Pinces flexibles isolées  
Pinzas flexibles aisladas  
Pinze flessibili isolate

Gastroskopie  
Gastroscopy  
Gastroscofie  
Gastroscopia  
Gastroscopia



Ø 1,8 mm



L cm

160 M53.212.16  
230 M53.212.23

Ø 2,2 mm



M53.222.16  
M53.222.23

Ø 2,6 mm



M53.232.16  
M53.232.23

Ø 3,4 mm



M53.242.16  
M53.242.23



Gastroskopie  
Gastroskopy  
Gastroskopia  
Gastroscofia  
Gastroscochia

∅ 2,2 mm



160 cm M53.291.16  
230 cm M53.291.23



160 cm M53.292.16  
230 cm M53.292.23

∅ 1,8 mm

Verjüngt . Tapered



M53.301.26 M53.301.16  
M53.301.33 M53.301.23

160 cm M53.341.16  
230 cm M53.341.23



M53.302.26 M53.302.16  
M53.302.33 M53.302.23

160 cm M53.342.16  
230 cm M53.342.23



160 cm M53.343.16  
230 cm M53.343.23



M53.304.26  
M53.304.23

160 cm M53.344.16  
230 cm M53.344.23



M53.311.26  
M53.311.23

160 cm M53.351.16  
230 cm M53.351.23



M53.312.26  
M53.312.23

160 cm M53.352.16  
230 cm M53.352.23



M53.313.26  
M53.313.23

160 cm M53.353.16  
230 cm M53.353.23



M53.314.26  
M53.314.23

160 cm M53.354.16  
230 cm M53.354.23



Tracheotomie  
Tracheostomy  
Trachéotomie  
Traqueotomía  
Tracheotomia

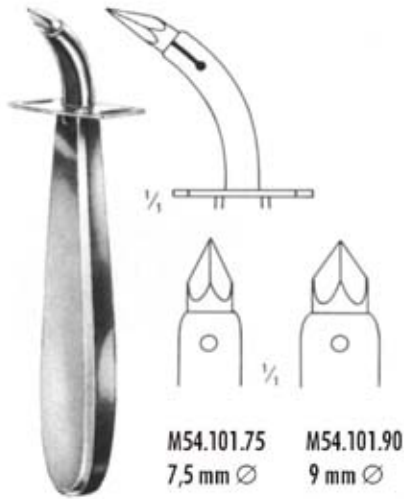

**UCKERMANN**  
M54.101.75-M54.101.90  
13 cm



**TROUSSEAU**  
M54.111.14  
14 cm



**LABORDE**  
M54.113.14  
14 cm



**BOSE**  
M54.115.07  
7 cm



**JACKSON**  
M54.116.15  
15 cm



**JACKSON**  
M54.117.17  
17 cm



**ITERSON**  
M54.118.16-M54.119.16  
16 cm



**BOSE**  
M54.112.16  
16 cm



**BOSE**  
M54.124.16  
16 cm

Tracheotomie  
Tracheostomy  
Trachéotomie  
Traqueotomía  
Tracheotomia



ROSE  
M54.130.13  
13 cm



mm WAGENER-MOSHER  
5 M54.151.05  
7 M54.151.07  
9 M54.151.09

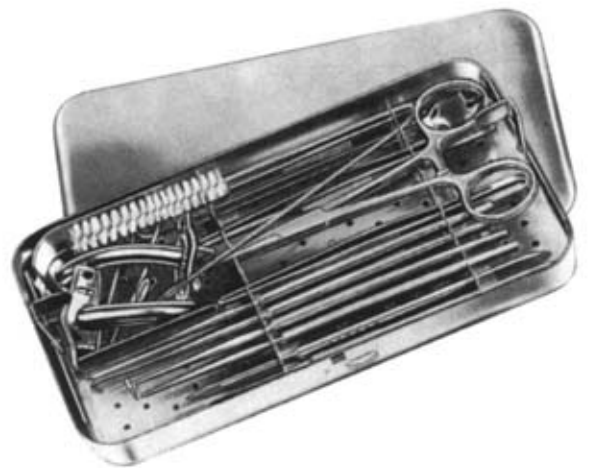

M54.270.00

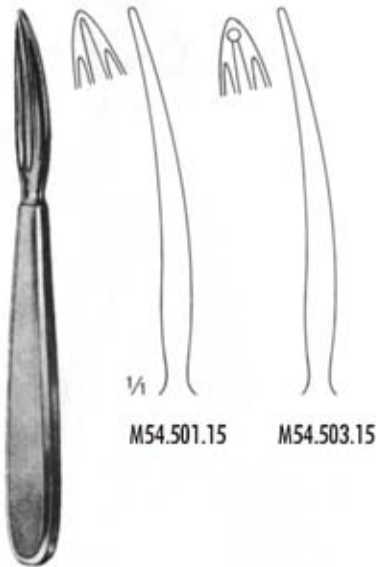

Fig.	mm	LUER
0	4	M54.220.04
1	5	M54.220.05
2	6	M54.220.06
3	7	M54.220.07
4	8	M54.220.08
5	9	M54.220.09
6	10	M54.220.10
7	11	M54.220.11
8	12	M54.220.12
9	13	M54.220.13



Fig.	mm	LUER
0	4	M54.240.04
1	5	M54.240.05
2	6	M54.240.06
3	7	M54.240.07
4	8	M54.240.08
5	9	M54.240.09
6	10	M54.240.10
7	11	M54.240.11
8	12	M54.240.12
9	13	M54.240.13

Kropf  
Goitre  
Goitre  
Bocio  
Gozzo



M54.501.15

M54.503.15

**KOCHER**  
M54.501.15-M54.503.15  
15 cm



**SCHOENBORN**  
M54.511.21  
21 cm



cm  
15  
20  
**LAHEY**  
M54.520.15  
M54.520.20



**MASTIN**  
M54.523.17  
17 cm

Thorax  
Thorax  
Thorax  
Tórax  
Torace

Rippenscheren  
Rib Shears  
Costomomes  
Costótomos  
Costotomi



M56.102.23  
23 cm



M56.105.22  
22 cm



GLUCK  
M56.107.22  
22 cm



STILLE  
M56.111.21  
21 cm

Rippenscheren  
Rib Shears  
Costotomes  
Costótomos  
Costotomi



CORYLLOS  
M56.123.35  
35 cm



BETHUNE  
M56.126.34  
34 cm



SAUERBRUCH  
M56.131.26



GIERTZ-STILLE  
M56.137.27  
27 cm



SAUERBRUCH-FREY  
M56.141.36  
36 cm



BRUNNER  
M56.147.28  
28 cm

Thorax  
Thorax  
Thorax  
Tórax  
Torace

Rippensperrer  
Rib Spreaders  
Ecarteurs des côtes  
Separadores costales  
Divaricatori costali

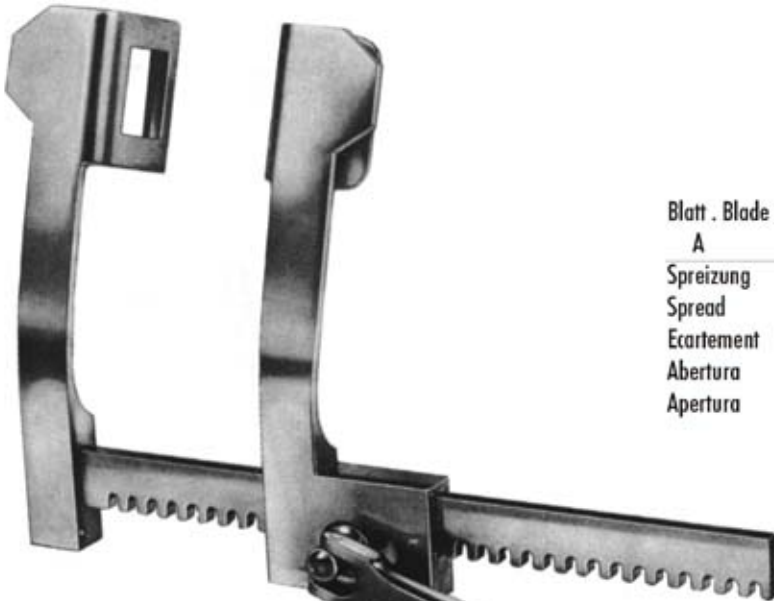

Blatt . Blade . valve . hoja . valva	A	B	C
Spreizung	Tiefe	Breite	
Spread	Depth	Width	
Ecartement	profondite	largeur	
Abertura	profundidad	ancho	
Apertura	profondita	larghezza	

FINOCHIETTO	A = mm	B = mm	C = mm
M56.210.16	165	40	40
M56.210.20	200	45	55
M56.210.25	250	70	65

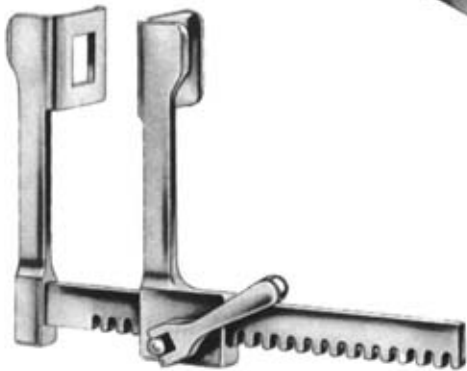

FINOCHIETTO-Baby	A = mm	B = mm	C = mm
M56.214.75	75	18	20



Aluminium



Aluminium

FINOCHIETTO-Infant	A = mm	B = mm	C = mm
M56.234.75	75	15	15

FINOCHIETTO	A = mm	B = mm	C = mm
M56.230.13	135	38	44
M56.230.17	175	52	62
M56.230	175	85	65

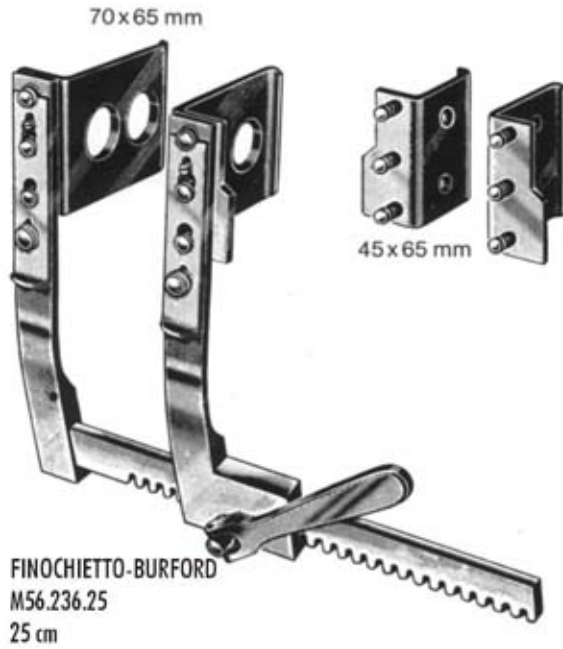

Rippensperrer  
Rib Spreaders  
Ecarteurs des côtes  
Separadores costales  
Divaricatori costali

FINOCHIETTO-BURFORD  
M56.236.25  
25 cm



Für Erwachsene  
Adult Size  
pour adultes  
para adultos  
per adulti

FINOCHIETTO-BURFORD  
M56.242.18 180 mm  
M56.242.26 260 mm  
M56.242.30 300 mm

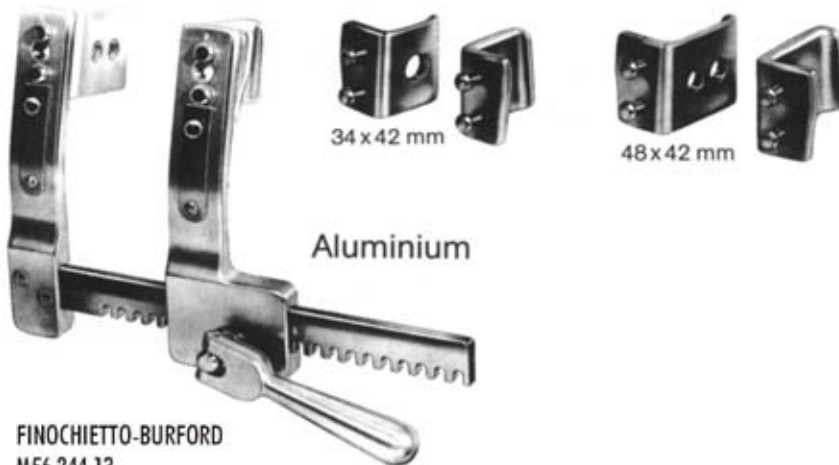

Für Kinder  
Child Size  
pour enfants  
para niños  
per bambini

FINOCHIETTO-BURFORD  
M56.244.13  
135 mm



Rippensperrer  
Rib Spreaders  
Ecarteurs des côtes  
Separadores costales  
Divaricatori costali

Blatt . Blade . valve . hoja . valva

A	B	C
Spreizung	Tiefe	Breite
Spread	Depth	Width
Ecartement	profondite	largeur
Abertura	profundidad	ancho
Apertura	profondita	larghezza

Aluminium



M56.250.06



M56.250.07



M56.250.12

CASTANEDA	A = mm	B = mm	C = mm
M56.250.06	65	10,5	32
M56.250.07	70	12	45
M56.250.12	120	15	60



HAIGHT	A = mm	B = mm	C = mm
M56.260.09	90	30	30



TUFFIER	A = mm	B = mm	C = mm
M56.254.16	156	50	45

Thorax  
Thorax  
Thorax  
Tórax  
Torace



75 x 75 mm



42 x 65 mm

Mercedes - compl.  
M56.270.00



M56.280.19



BAILEY-Baby  
M56.282.14



BAILEY  
M56.284.16



BAILEY-GIBBON  
M56.286.16



ALLISON  
M56.289.32  
32 cm

Lunge  
Lung  
Poumon  
Pulmón  
Polmone

Bonchus-Klemen . Bronchus Forcqs . Pincas  
clamps pour les bronches . Pinzas clamps  
bronquales . Pinze per bronchi

Lungenfaßzangen  
Lung Grasping forceps  
Pincas à saisir le poumon  
Pinzas para coger el pulmon  
Pinze per afferrare il polmone



LOVELACE  
M56.290.20  
20 cm



LOVELACE  
M56.291.20  
20 cm



HARRINGTON  
M56.301.30  
30,5 cm

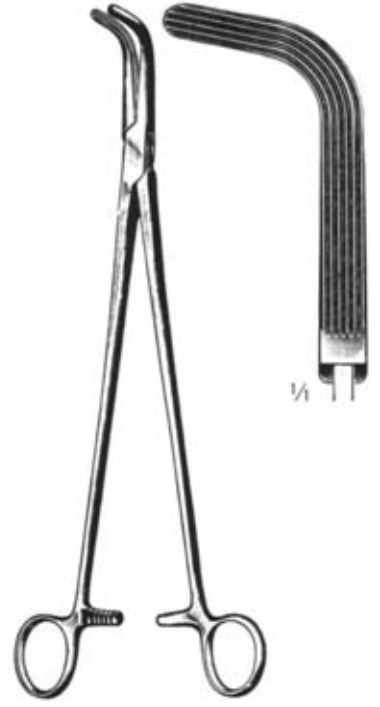

HARRINGTON  
M56.303.29  
29,5 cm



FINOCCHIETTO  
M56.307.24  
24 cm



PRICE-THOMAS  
M56.309.22  
22 cm

Links  
left  
à gauche  
izquierda  
sinistra



PRICE-THOMAS  
M56.311.22 22 cm M56.313.22

Rechts  
right  
à droite  
derecha  
destra

Bonchus-Klemen . Bronchus Forcps . Pinces  
clamps pour les bronches . Pinzas clamps  
bronquales . Pinze per bronchi

Lunge  
Lung  
Poumon  
Pulmón  
Polmone

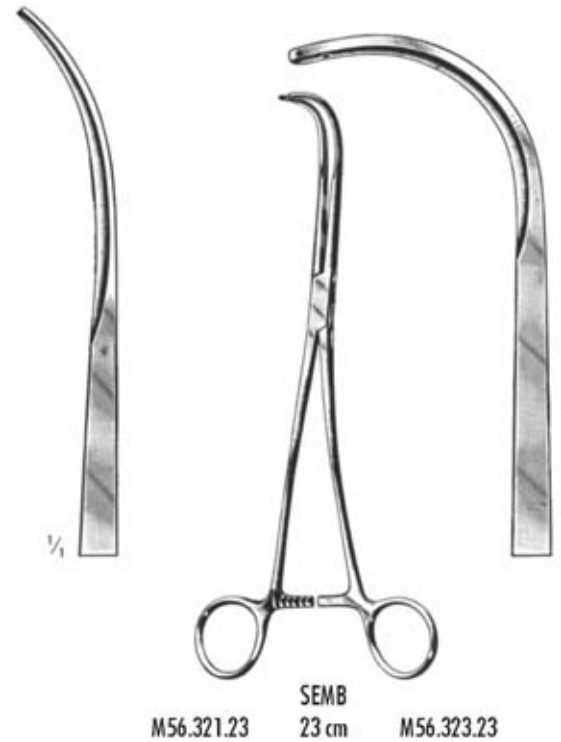
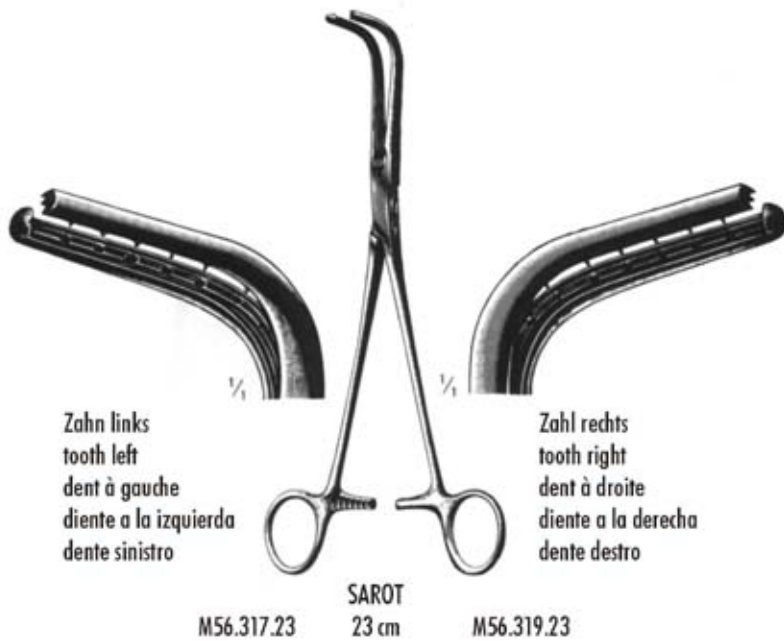

Anastomosen-Klemmen  
Anastomosis Clamps  
Pinces à anastomose  
Pinzas para anastomosis  
Pinze per anastomosi

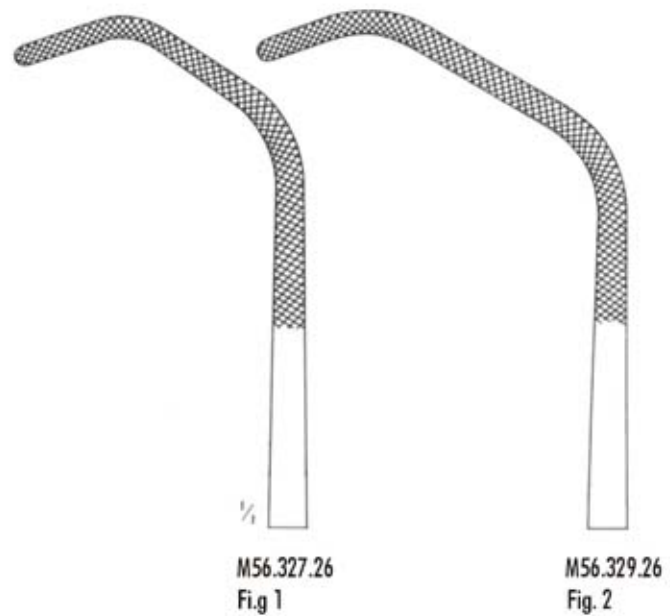

Galle  
Gall Bladder  
Voies biliaires  
Vesícula biliar  
Vescicola biliare



DESJARDINS  
M62.101.23-M62.103.23



M62.101.23  
Fig. 1

M62103.23  
Fig. 2



BLAKE  
M62.106.20 20 cm M62.107.20



MAYO BLAKE  
M62.110.20 20 cm

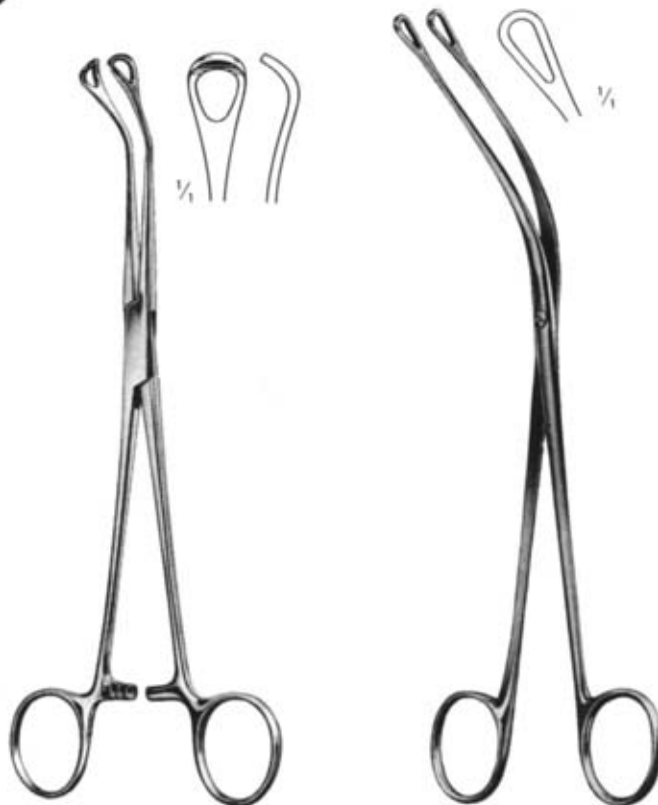

MAYO-BLAKE  
M62.111.20  
20 cm

MIXTER  
M62.117.22  
22 cm



MOORE  
M62.125.28

OCHSNER  
M62.128.35

Galle  
Gall Bladder  
Voies biliaires  
Vesicula biliar  
Vescicola biliare

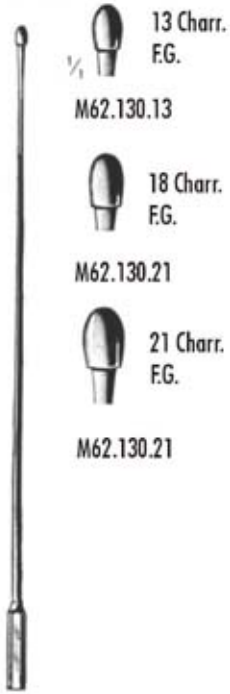

**DESJARDINS**  
M62.130.13-M62.130.21  
28 cm



**MOYNHAN**  
M62.142.34  
34 cm

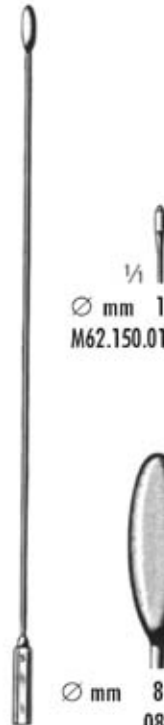

**BAKES**  
M62.150.00 - M62.150.13  
30 cm

1/2  
Ø mm 1  
M62.150.01

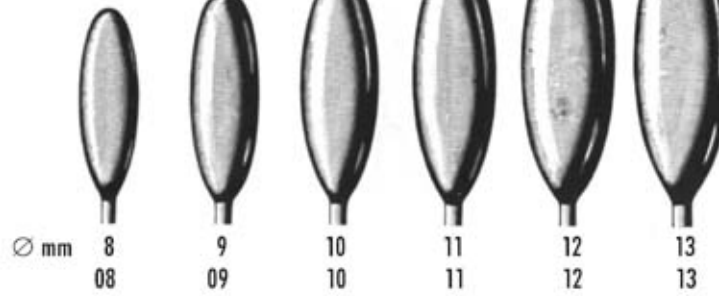
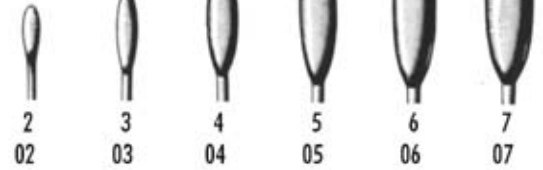

M62.150.00 = Set compl./9



**FERGUSSON**  
M62.170.21  
21,5 cm



**MAYO**  
M62.175.27  
27 cm



**MAYO**  
M6 2.178.01 - M62.178.03  
27 cm



M62.178.01  
klein . Small . petite  
pequena . piccola



M62.178.03  
gross . Large . grade



17 Charr.  
FG.



21 Charr.  
FG.



24 Charr.  
FG.



27 Charr.  
FG.

**DESJARDINS**  
M62.180.17 - M62.180.27

Niere  
Kidney  
Rein  
Riñon  
Rene

Nierensteinzangen  
Kidney Stone Forceps  
Pinces à calculs renaux  
Pinzas para cálculos renales  
Pinze per calcoli renali



MAYO  
M62.210.32  
32 cm

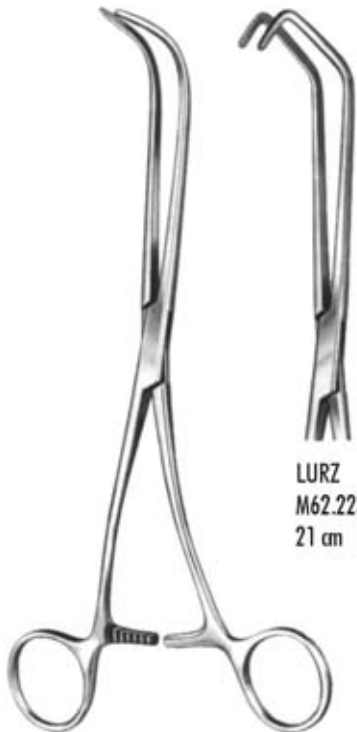

LURZ  
M62.223.21  
21 cm

Unterklappen  
Ureter Clamps  
Pinces-clamps à uretère  
Pinzas clamps para ureter  
Pinze per uretere



RANDALL  
M62.231.01 - M62.231.06

RANDALL	Fig.	cm
M62.231.01	1	23
M62.231.02	2	22
M62.231.03	3	22
M62.231.04	4	22
M62.231.05	5	19
M62.231.06	6	19

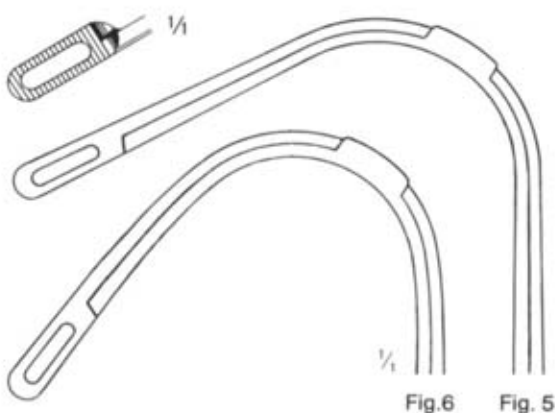

Fig. 6 Fig. 5

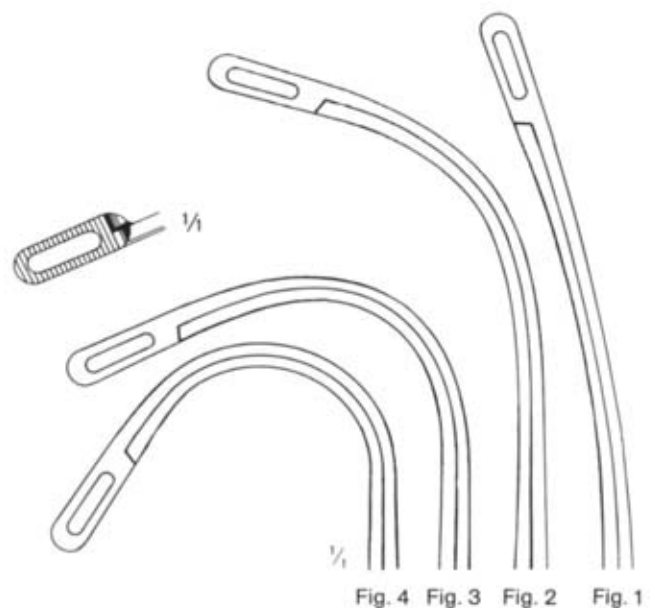
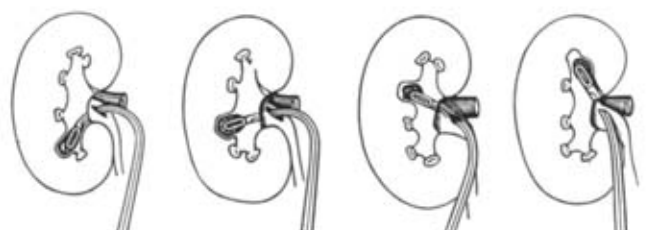

Fig. 4 Fig. 3 Fig. 2 Fig. 1

in situ:



5-6



4 3 2 1

Darm- Und Gewebefäßzangen  
Bowl and Tissue Grasping Forceps  
Pincès à saisir les intestins et les tissus  
Pinzas para coger intestinos y tejidos  
Pinzas para coger intestinos y tejidos  
Pinze per afferrare intestini e tessuti

Darm, Magen  
Intestines and Stomach  
Intestin, Estomac  
Intestines, Estómago  
Intestini, Stomaco



ALLI-Baby  
M64.102.14  
14 cm



4:5	ALLIS	5:6
M64.110.15	15 cm	M64.120.15
	19 cm	M64.120.19
	22 cm	M64.120.22
	24 cm	M64.120.24



Atraumatisch  
atraumatic  
atraumatique  
atraumática  
atraumatica

cm	ALLIS
16	M64.124.16
20	M64.124.20
25	M64.124.25



ALLIS-ADAIR  
M64.130.15  
15,5 cm



cm	JUDD-ALLIS
15	M64.140.15
19	M64.140.15



THOMS-ALLIS
M64.150.20
20 cm

Mit TC-Einsätzen  
TC Lined  
A mors TC  
Con bocas TC  
Con mmorso TC



cm	BABCOK	TC	
16	M64.160.16	M64.164.16	M64.168.16
18	M64.160.18		
20	M64.160.20	M64.164.20	M64.168.20
24	M64.160.24		

Atraumatisch  
atraumatic  
atraumatique  
atraumática  
atraumatica



Darm, Magen  
Intestines and Stomach  
Intestin, Estomac  
Intestines, Estómago  
Intestini, Stomaco

Mit TC-Einsätzen  
TC Lined  
A mors TC  
Con bocas TC  
Con mmorso TC



DUVAL  
13 mm

cm	
18	M64.170.18
20	M64.170.20
20	M64.174.20
23	



DUVAL  
25 mm

	M64.172.20
	M64.172.23



DUVAL  
M64.170.18-M64.174.20



WILLIAMS  
M64.180.16  
16,5 cm



SCHOENBURG  
M64.182.22  
22 cm



DOYEN  
DOYEN-Baby  
M64.210.18-M64.217.23

Damenklemmen  
Intestinal Forceps  
Pinces intestinales  
Pinzas intestinales  
Pinze intestinali

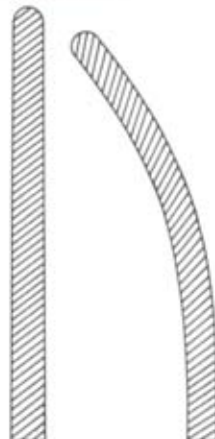

cm	DOYEN-Baby
16	
18	M64.210.18 M64.210.21
21	M64.210.21
23	M64.210.23

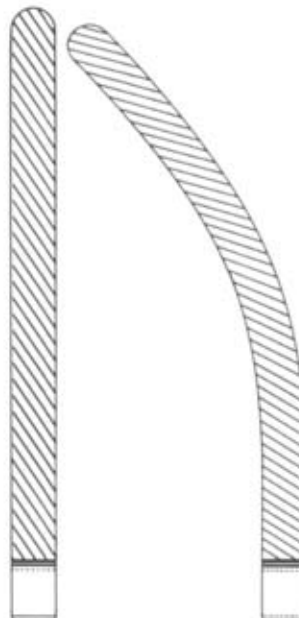

cm	DOYEN	DOYEN
16		M64.216.16 M64.217.16
18	M64.210.18 M64.210.21	M64.216.18 M64.217.18
21	M64.210.21	M64.216.21 M64.217.21
23	M64.210.23	M64.211.23 M64.216.23 M64.217.23

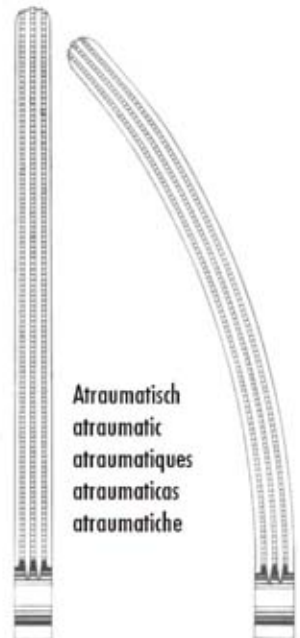

Atraumatisch  
atraumatic  
atraumatic  
atraumatic  
atraumatiche

Darmklemmen  
Intestinal Forceps  
Pincas intestinales  
Pinzas intestinales  
Pinze intestinali

Darm, Magen  
Intestines and Stomach  
Intestin, Estomac  
Intestines, Estómago  
Intestini, Stomaco

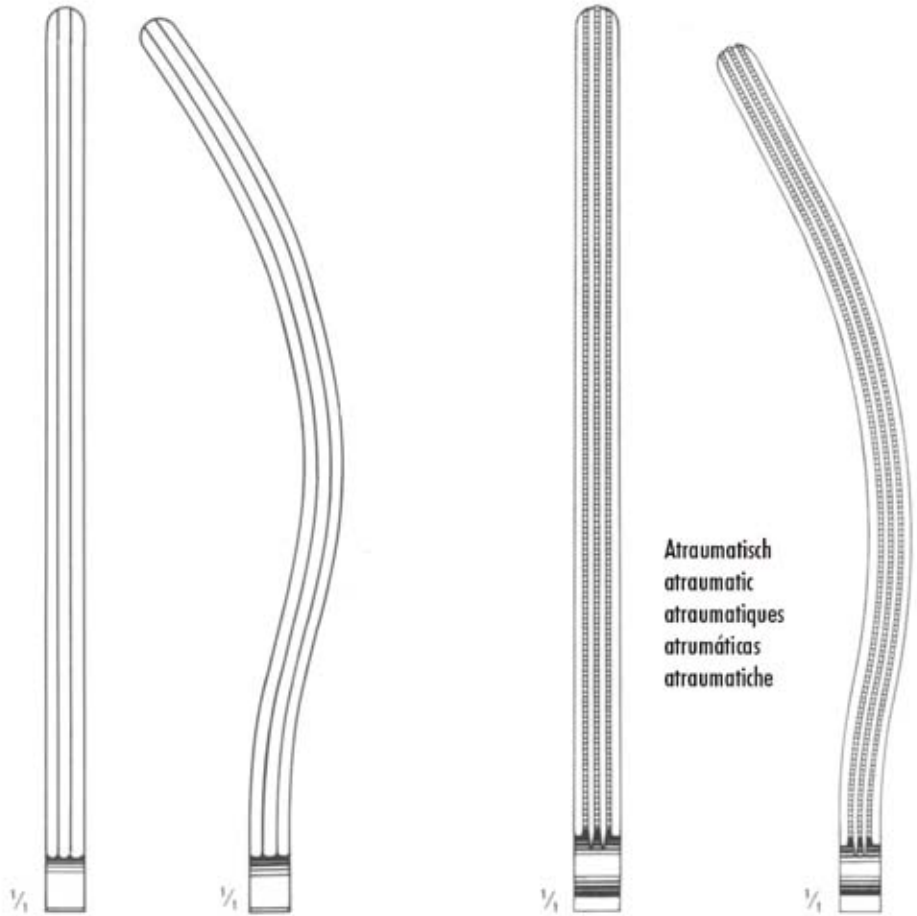

cm	KOCHER			
2	M64.220.22	M64.221.22	M64.226.22	M64.227.22
25	M64.220.25	M64.221.25	M64.226.25	M64.227.25
28	M64.220.28	M64.221.28	M64.226.28	M64.227.28

Darm, Magen  
Intestines and Stomach  
Intestin, Estomac  
Intestines, Estómago  
Intestini, Stomaco

Darmklemmen  
Intestinal Forceps  
Pincas intestinales  
Pinzas intestinales  
Pinze intestinali



MAYO-ROBSON  
M64.230.25-M64.237.25  
25 cm



M64.230.25

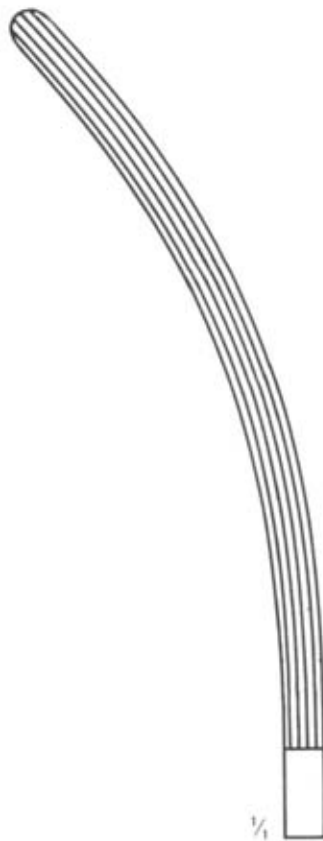

M64.231.25

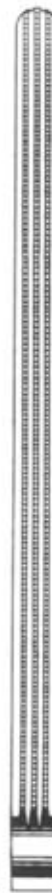

M64.236.25

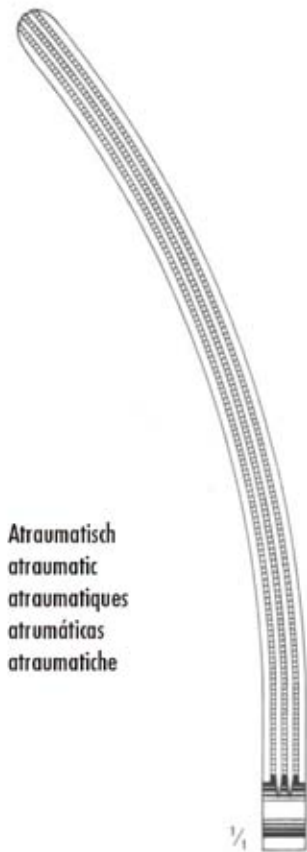

M64.237.25

Atraumatisch  
atraumatic  
atraumatiques  
atrumáticas  
atraumatiche

MAYO-ROBSON



Normal FEHLAND atraum.  
M64.241.23 23,5 cm M64.247.23



mm	BEST
30	M64.251.30
60	M64.251.60
75	M64.251.75

BEST  
M64.251.30-M64.251.75  
26,5 cm

Darm, Magen  
Intestines and Stomach  
Intestin, Estomac  
Intestines, Estómago  
Intestini, Stomaco

Darm- und magenklemmen  
Intestinal and Stomach Clamps  
Pincas-clamps intestinales  
Pinzas-clamps intestinales y estomacales  
Pinze intestinali e stomacali



BRUNNER  
M64.260.24-M64.266.24  
24 cm

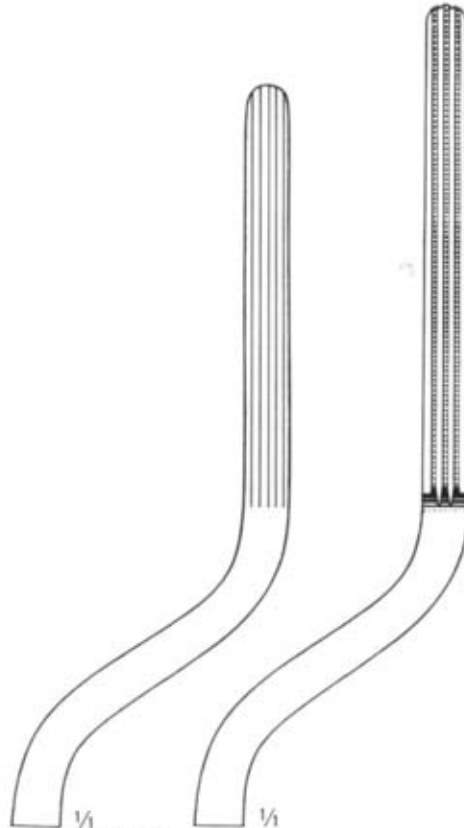

BRUNNER  
M64.260.24 M64.266.34

Utraumatich  
atraumatic  
atraumatique  
atraumática  
atraumatica

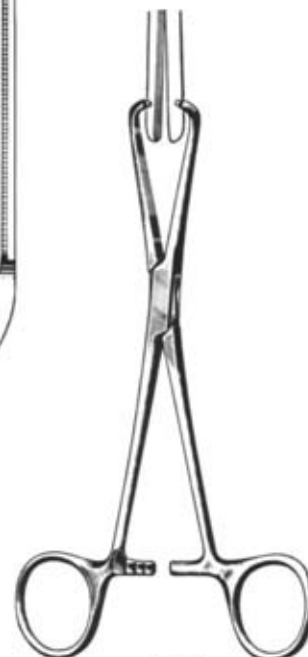

STONE  
M64.270.15  
15,5 cm



STONE-WATT  
M64.274.00



STONE-WATT  
M64.72.07  
M64.272.10  
cm  
7,5  
10

Darm, Magen  
 Intestines and Stomach  
 Intestin, Estomac  
 Intestines, Estómago  
 Intestini, Stomaco

Anastomosenklemen und Zubehör  
 Anastomosis clamps and Accessories  
 Clamps `a anastomose et accessoires  
 Clamps para anastomosis y accesorios  
 Pinze per anastomosi e accessori

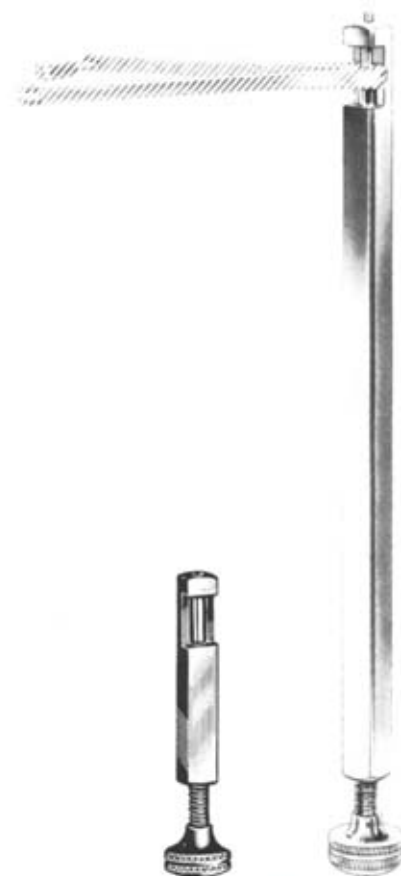
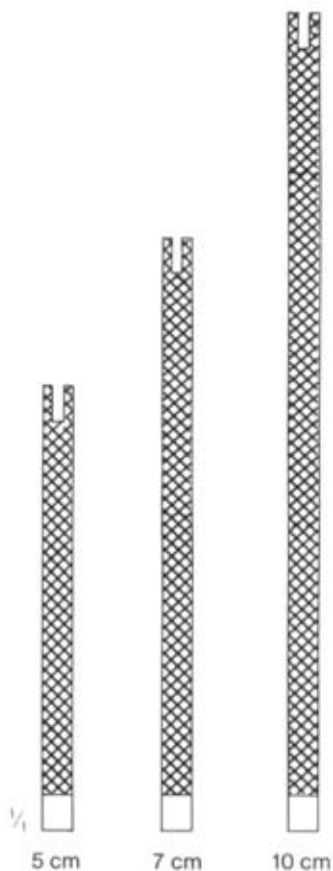

cm DE MARTEL-WOLFSON  
 5 M64.280.05  
 7 M64.280.07  
 10 M64.280.10  
 Set/3

DE MARTEL-WOLFSON  
 M64.282.26  
 26 cm

DE MARTEL-WOLFSON  
 M64.284.08-M64.284.23  
 8,5 cm      23 cm

Magenklemen  
Stomach Clamps  
Pincés-clamps stomacales  
Pinzas-clamps estomacales  
Pinze stomacali

Darm, Magen  
Intestines and Stomach  
Intestin, Estomac  
Intestines, Estómago  
Intestini, Stomaco

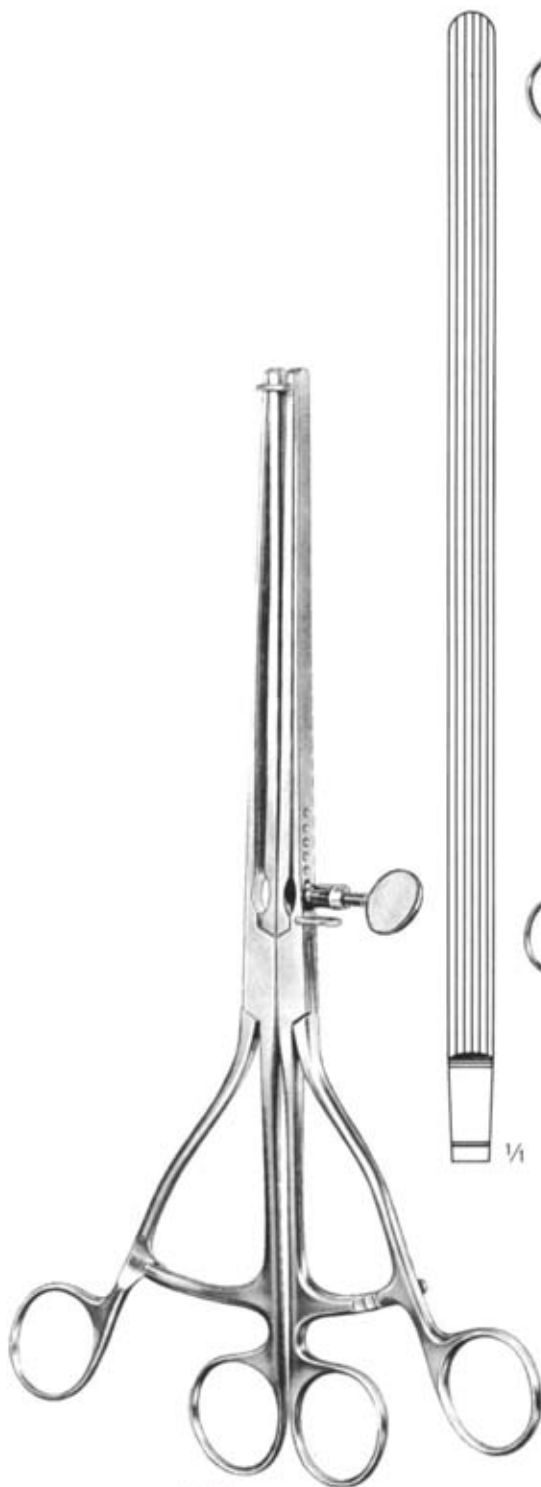

LANE  
M64.290.30  
30 cm



LANE  
M64.291.30  
30 cm

Darm, Magen  
Intestines and Stomach  
Intestin, Estomac  
Intestines, Estómago  
Intestini, Stomaco

Magenklemen  
Stomach Clamps  
Pincas-clamps stomacales  
Pinzas-clamps estomacales  
Pinze stomacali

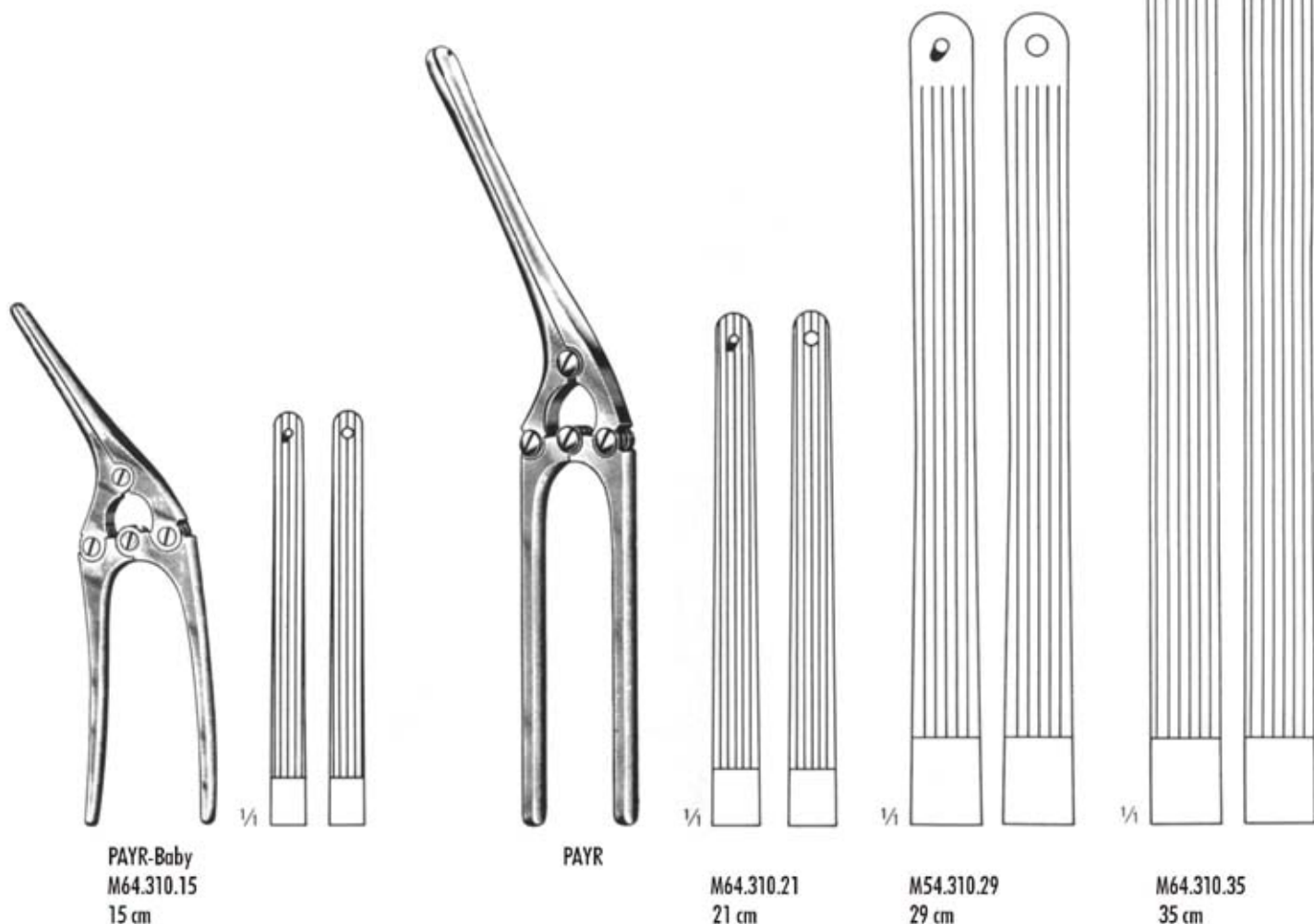

PAYR-Baby  
M64.310.15  
15 cm

PAYR

M64.310.21  
21 cm

M54.310.29  
29 cm

M64.310.35  
35 cm

Magen- und Darmnähsapparat . Stomach and Intestinal Suturing Apparatus . Appareli à sutures stomacales et intestinales  
Aparato para suturas estomacales e intestinales . Apparecchio per suture stomacali e intestinali



V. PETZ  
M64.320.00  
compl.



300 Stück  
300 ea  
300 pièces  
300 c/u  
300 pezzi

M64.321.00

Prostata - Hacken, -faßzange  
Prostatic Retractors, Grasping forceps  
Ecarteurs à prostate, Pince à saisir la prostate  
Separadores Pinza para coger prostata  
Divaricatori, Pinza per afferrare la prostata

Urologie  
Urology  
Urologie  
Urologia  
Urologia



YOUNG  
M66.101.21  
21 cm



YOUNG  
M66.103.22  
22 cm



YOUNG  
M66.105.21  
21 cm



YOUNG  
M66.106.20  
20 cm



MILLIN  
M66.111.23-M66.125.24

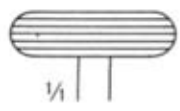

M66.111.23

Atraumatisch  
atraumatic  
atraumatique  
atraumática  
atraumatica

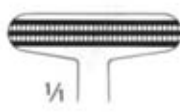

M66.116.23  
23 cm

Für die Kapsel  
for the capsule  
Pour la capsule  
Para la cápsula  
Per lacapsula



MILLIN  
M66.123.23  
23 cm

für die vord. Lappen  
Anterio lobe  
Pour lobe antérieur  
Para lobo anterior  
Per lobo anteriore



MILLIN  
M66.125.24  
24 cm

Fadenführer  
Ligature Carrier  
Porte-ligature  
Porta-ligaduras  
Portafilo



Urologie  
Urology  
Urologie  
Urología  
Urologia

Blasenspatel, -Wundsperrer  
Bladder Retractors, Spereaders  
Spatules, Ecarteurs vésicaux  
Expátulas, Separadores vesicales  
Spatole, Divaricatori vescicali



JUDD-MASSON  
M66.150.00



LEGUEU  
M66.147.27

KOCHER  
M66.149.27



THOMSON-WALKER  
M66.160.00

Urologie  
Urology  
Urologie  
Urologia  
Urologia



LEGUEU  
M66.163.00



MILLIN  
M66.165.00

Fremdkörperzangen  
Foreign Body Forceps  
Pinces à corps étrangers  
Pinzas para cuerpos extranjerros  
Pinze per corpi estranei

Urethrotom, Messer auswärts  
Urethrotome, cutting outward  
Urétrotome, tranchant exérieur  
Uretrótomo, coltelli esteriori

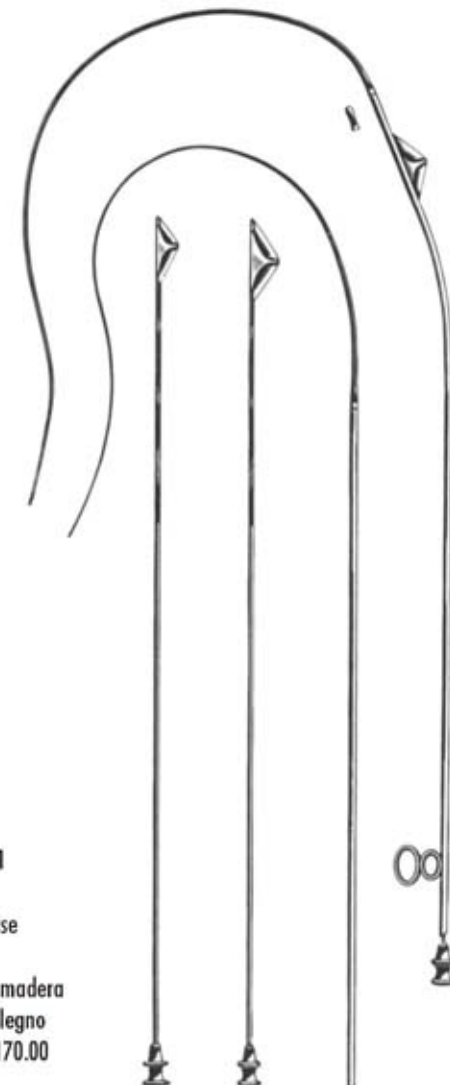

M66.170.01  
Holzetui  
Wooden Case  
Boite bois  
Estuche de madera  
Astuccio in legno  
f./p. M66.170.00

MAISONNEUVE  
M66.170.00  
compl.

cm MATHIEU  
20 M66.168.20  
28 M66.168.28

Urologie  
Urology  
Urologie  
Urología  
Urologia

Sekretlöffel, Katheterspanner  
Secretions scoops, Catheter introducer  
Cuiller à sécrétions, Introducteur de sondes  
Cucharillas p. Secreciones, Introducitor de catéteres  
Cucchiai per secrezioni, mandrini per sonde uretrali

Penisklemmen  
Meatus clamps  
Compresseurs de l'urètre  
Compresores uretrales  
Serrapene



STOCKMANN  
M66.175.08  
8 cm



STRAUSS  
M66.177.11  
11 cm



GUTTMANN  
M66.180.26

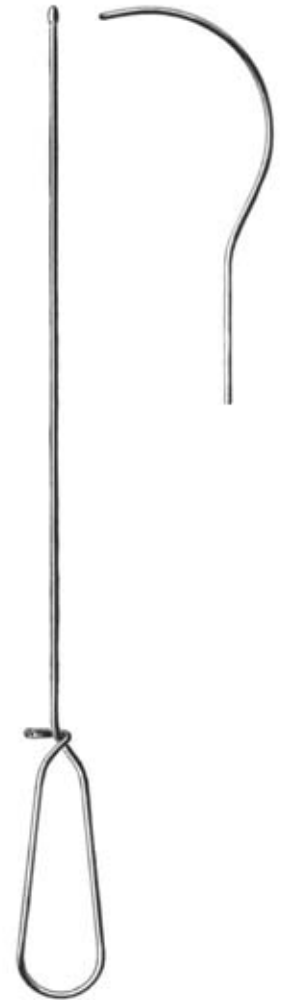

GUYON  
M66.184.39 39 cm  
M66.185.35 35 cm

Harnröhren-dilatationsbesteck  
Urethral dilation set  
Jeu d'instruments pour la dilatation de l'urètre  
Juego de instrumentos para la dilatación de la uretra  
Set di strumenti per la dilatazione uretrale

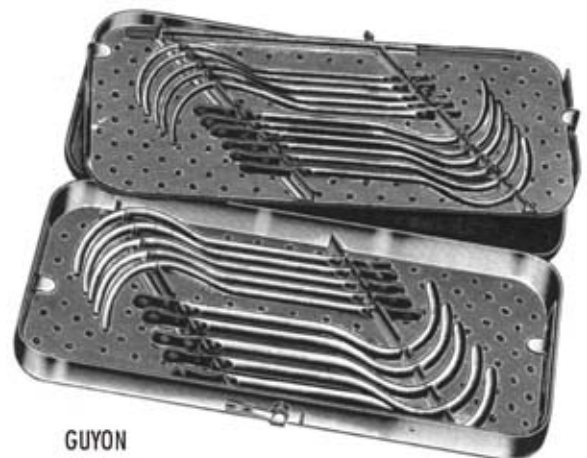

GUYON  
M66.200.00  
compl.

Dilations-Bougies, metall-katheter  
 Dilating Bougies, metal Catheters  
 bougies dilatatrices, Sondes métalliques  
 Bujias dilatadoras, sondas metálicas  
 candelette dilatatrici, sinde metalliche

Urologie  
 Urology  
 Urologie  
 Urología  
 Urologia



Charr./F.G.	van BUREN	GUYON*			COXETER
8	M66.201.08	M66.205.08	M66.211.08	M66.213.08	M66.219.08
10	M66.201.10	M66.205.10	M66.211.10	M66.213.10	M66.219.10
12	M66.201.12	M66.205.12	M66.211.12	M66.213.12	M66.219.12
14	M66.201.14	M66.205.14	M66.211.14	M66.213.14	M66.219.14
16	M66.201.16	M66.205.16	M66.211.16	M66.213.16	M66.219.16
18	M66.201.18	M66.205.18	M66.211.18	M66.213.18	M66.219.18
20	M66.201.20	M66.205.20	M66.211.20	M66.213.20	M66.219.20
22	M66.201.22	M66.205.22	M66.211.22	M66.213.22	M66.219.22
24	M66.201.24	M66.205.24	M66.211.24	M66.213.24	M66.219.24
26	M66.201.26	M66.205.26			
28	M66.201.28	M66.205.28			
30	M66.201.30	M66.205.30			
32	M66.201.32	M66.205.32			
34	M66.201.34	M66.205.34			
36	M66.201.36	M66.205.36			
38		M66.205.38			
40		M66.205.40			

M66.201.00  
 Set compl.  
 8-36

	Ch./F.G.	No.
* Zwischengrößen:	9	M66.205.09
Intermediate sizes:	11	M66.205.11
Dimensions intermédiaires:	.	.
Dimensiones intermediarias:	.	.
Dimensioni intermediari:	39	M66.205.39

Mastdarm  
Rectum  
Rectum  
Recto  
Retto

Mastdarm-Spekula  
Rectal Specula  
Spéculums rectaux  
Expéculos rectales  
Specoli rettali



MARTIN-NASAL  
M68.135.13  
13cm  
Straight



MARTIN-NASAL  
M68.140.13  
13 cm  
Curved

Mastdarm-Spreizer  
anal Retractors  
Dilataeurs p. Anus et rectum  
separadores rectales  
Dilatatori per l'ano e il retto

Mastdarm  
Rectum  
Rectum  
Recto  
Retto



ALAN-PARKS  
M68.147.00  
compl.  
13,5 cm



SMITH-BUIE  
M68.150.15  
75 x 23 mm  
15 cm

M68.148.00  
kaltlicht-Adapter für m68.147.00  
cold Light Attachment for M68.147.00  
Adaptateur lumière froide pour M68.147.00  
Adattatore luce fredda per M68.147.00

Rektoskop  
Rectoscope  
Rectoscope  
Restoscopio  
Retoscopio



STRAUSS  
M68.160.00  
compl.

STRAUSS  
kaltlicht . Cold light . Lumière froide . Luz fría . Luce fredda  
M68.161.00 compl

Mastdarm  
Rectum  
Rectum  
Recto  
Retto

Anoskope, Proktoskope  
Anoscopes, Proctoscopes  
anuscopes, Proctoscopes  
Anoscopios, Proctocopios  
Anoscopi, Proctoscopi



IVES-FANSLER  
M68.210.22  
22 mm  
L = 80 mm



Ø mm	HIRSCHMANN
16	M68.212.16
19	M68.212.19
22	M68.212.22
	L = 65 mm



Mm		KELLY
Ø x L		M68.220.05
22 x 50		M68.220.10
22 x 100		M68.220.14
22 x 140		M68.220.20



Ø mm	KELLY
21	M68.224.21
27	M68.224.27
	L = 50 mm

Cystikus - .Haken  
Cystic Hooks  
Ecarteurs rectaux  
Ganchos rectales  
Uncini rettali



M68.251.01  
Fig. 1

M68.251.02  
Fig. 2

M68.251.03  
Fig. 3

PRATT  
M68.251.01-M68.251.03



BUIE  
M68.261.41  
41 cm

Mastdarm  
Rectum  
Rectum  
Recto  
Retto

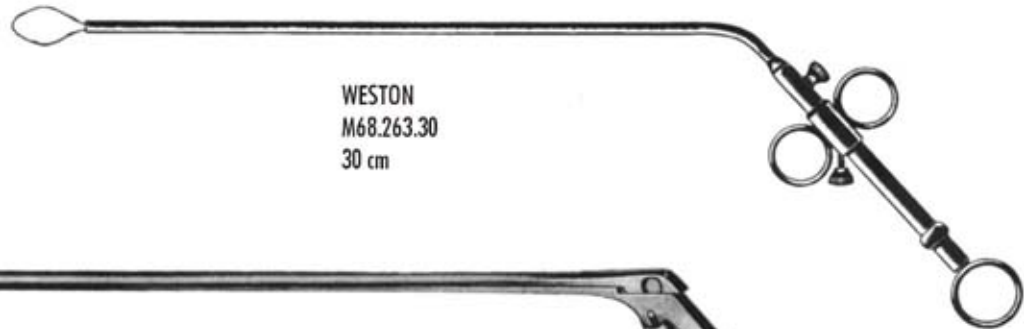

Biopsie-Zangen  
Biopsy specimen forceps  
Pinces emporte-pièce à biopsie  
Pinzas sacabocado para biopsia  
Pinze per biopsia

WESTON  
M68.263.30  
30 cm

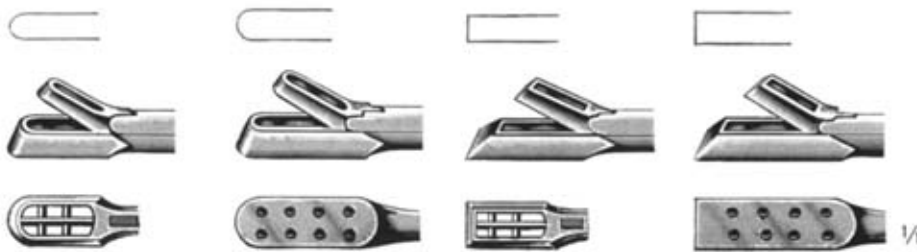
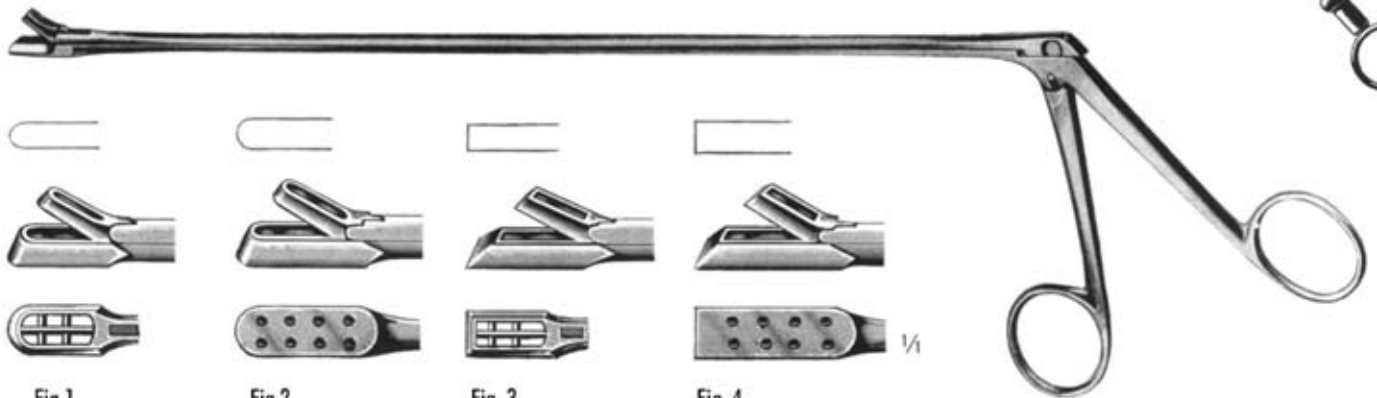

Fig.1	Fig.2	Fig.3	Fig.4	
M68.301.28	M68.302.28	M68.303.28	M68.304.28	28 cm
M68.301.35	M68.302.35	M68.303.35	M68.304.35	35 cm
M68.301.42	M68.302.42	M68.303.42	M68.304.42	42 cm

YEOMAN



Drehbar  
rotatable  
rotative  
giratoria  
girevole

cm	YEOMAN
23	M68.311.23
33	M68.311.333
40	M68.311.40



Drehbar  
rotatable  
rotative  
giratoria  
girevole

cm	TURREL
23	M68.321.23
33	M68.321.33
40	M68.321.40

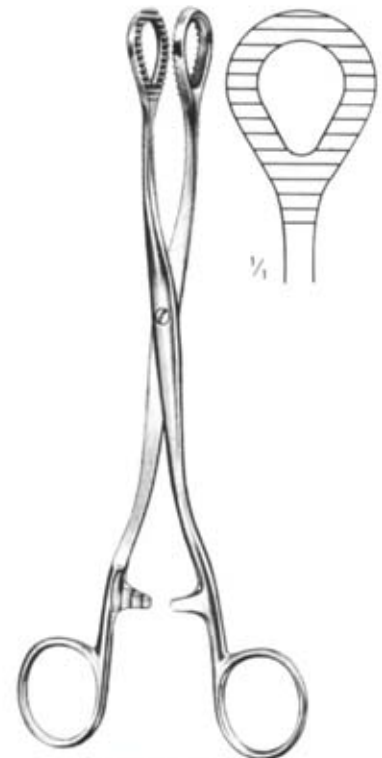

HEYWOOD-SMITH  
M68.402.21  
21 cm



Gynäkologie  
Gynecology  
Gynécologie  
Ginecologia  
Ginecologia

Scheiden-Spekula  
Vaginal Specula  
Dspeculums vaginaux  
Expeculos vaginales  
speculi vaginali



**GRAVE**

Fig.	mm	Standard	Laser Mod.
1	75 x 20	M 70.110.01	
2	95 x 35	M70.110.02	M70.114.02
3	115 x 35	M70.110.03	M70.114.03



	Fig.	mm
M70.120.01	1	75 x 13
M70.120.02	2	100 x 22
M70.120.03	3	120 x 25

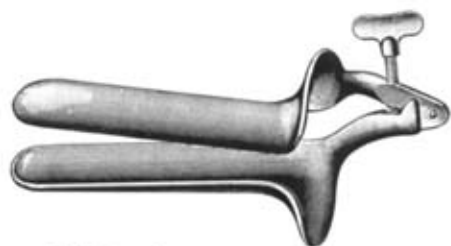

COLLIN	Fig.	mm
M70.130.01	1	85 x 30
M70.130.02	2	100 x 35
M70.130.03	3	110 x 40



**COLLIN**  
M70.131.00  
65 x 20 mm



**COLLIN**  
M70.132.00  
65 x 10 mm



<b>CUSCO</b>			
Fig.	mm	Standard	Laser Mod
1	75 x 32	M70.140.01	
2	85 x 35	M70.140.02	M700.144.02
3	100 x 35	M70.140.03	M70.144.03

Gynäkologie  
Gynecology  
Gynécologie  
Ginecología  
Ginecologia



Scheiden-Spekula  
Vaginal Specula  
Dpeculums vaginaux  
Expeculos vaginales  
specoli vaginali

CUSCO  
M70.142.00  
75 x 17 mm

Schweizer Modell . Swiss Pattern  
Modele suisse Modelo suizo  
M0dello svizzero



CUSCO	Fig.	mm
M70.160.01	1	90 x 23-25
M70.160.02	2	100 x 25-27
M70.160.03	3	110 x 27-30

Mittelschraube . Central Screw  
Vis centrale . Tornillo  
centrale . Vite  
centrale



CUSCO	Fig.	mm
M70.150.01	1	75 x 32
M70.150.02	2	85 x 36
M70.150.3	3	95 x 37

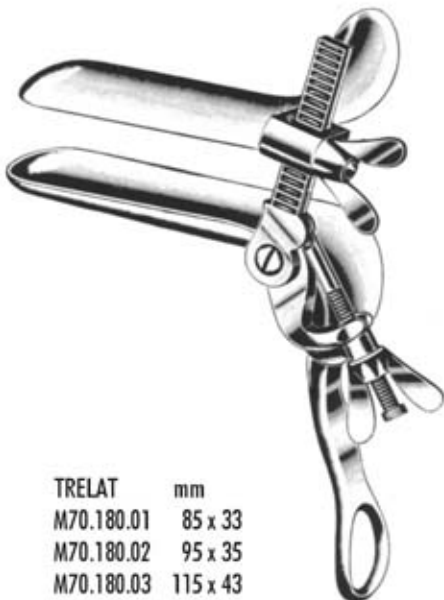

TRELAT	mm
M70.180.01	85 x 33
M70.180.02	95 x 35
M70.180.03	115 x 43

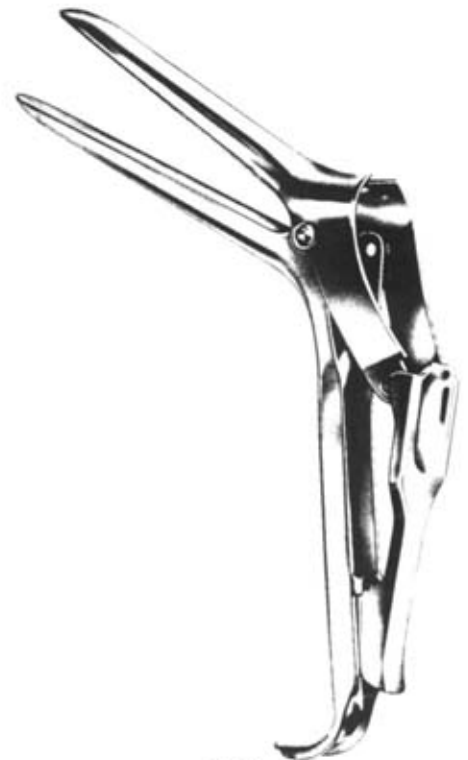

SEMM	mm
M70.190.01	100 x 17-20
M70.190.02	100 x 25-30

Gynäkologie  
Gynecology  
Gynécologie  
Ginecologia  
Ginecologia

Scheiden-Spekula  
Vaginal Specula  
Dspeculums vaginaux  
Expeculos vaginales  
specoli vaginali

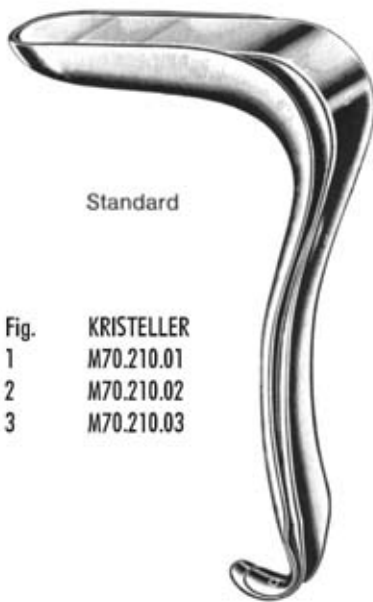

Standard

Fig. KRISTELLER  
1 M70.210.01  
2 M70.210.02  
3 M70.210.03

KRISTELLER Fig. mm  
M70.211.01 1 70 x 27  
M70.211.02 2 80 x 30  
M70.211.03 3 90 x 36

Spekulum  
Speculum  
Speculum  
Expeculo  
Specolo

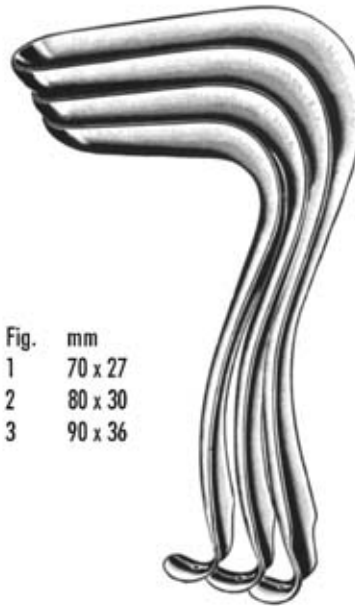

KRISTELLER Fig. mm  
M70.212.01 1 75 x 23  
M70.210.02 2 85 x 26  
M70.210.03 3 100 x 32

Halter  
Retractor  
Valve  
Valva

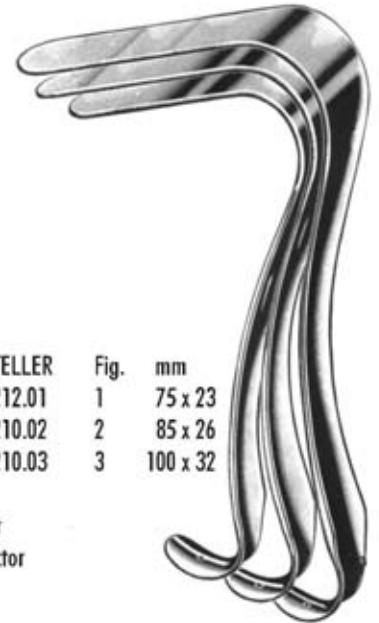

Mit konischen Blättern, für Jungfrauen  
With taper blades, for virgins  
A valves coniques, pour vierges  
Con valve coniche, per vergini



Fig. KRISTELLER  
1 M70.220.01  
2 M70.220.02

Satz  
Set  
Jeu  
Juego  
Set



KRISTELLER mm  
M70.221.01 105 x 18  
M70.221.02 105 x 21

Spekulum  
Speculum  
Speculum  
Expeculo  
Specolo

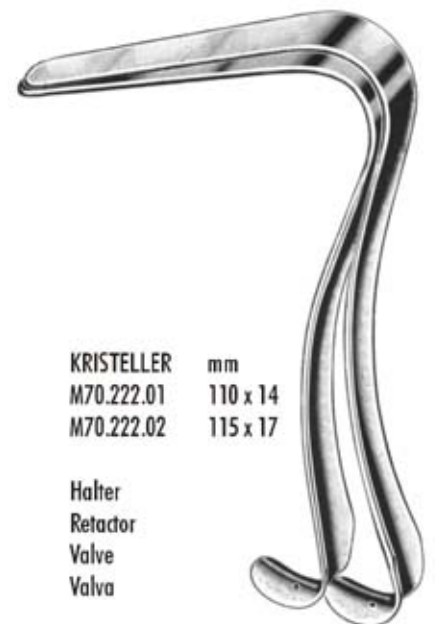

KRISTELLER mm  
M70.222.01 110 x 14  
M70.222.02 115 x 17

Halter  
Retactor  
Valve  
Valva

Gynäkologie  
Gynecology  
Gynécologie  
Ginecología  
Ginecologia



Fig. KRISTELLER  
1 M70.230.01  
2 M70.230.02  
3 M70.230.03

Sat  
Set  
Jeu  
Juego  
Set

Flasche Specula  
Specula Flat Hollow  
Speculums plats  
Especulos con huecos planos  
Specolo

KRISTELLER	Fig.	mm
M70.321.01	1	105 x 26
M70.231.02	2	105 x 28
M70.231.03	3	105 x 33

Spekulum  
Speculum  
Speculum  
Especulo  
Specolo



KRISTELLER	Fig.	mm
M70.232.01	1	115 x 22
M70.232.02	2	115 x 24
M70.232.03	3	115 x 29

Halter  
Retractor  
Valve  
Valva

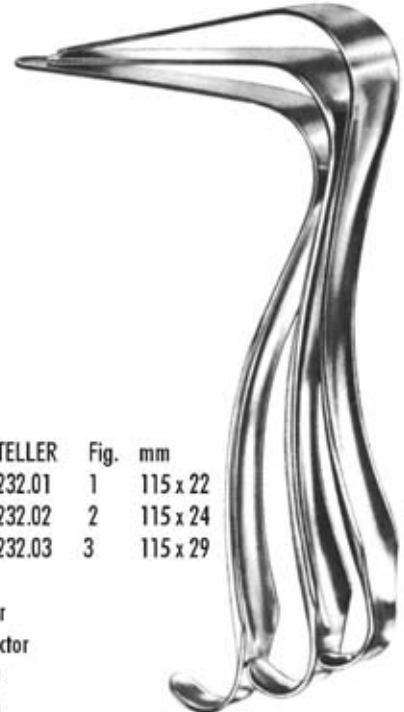

Fig. KRISTELLER  
1 M70.240.01  
2 M70.240.02  
3 M70.240.03

Sat  
Set  
Jeu  
Juego  
Set

Tiefe Spekula  
specula deep Hollow  
Speculums profonds  
Especulos con huecos profundos  
Specoli profondi

KRISTELLER	Fig.	mm
M70.241.01	1	110 x 27
M70.241.02	2	110 x 30
M70.241.03	3	110 x 36

Spekulum  
Speculum  
Speculum  
Especulo  
Specolo

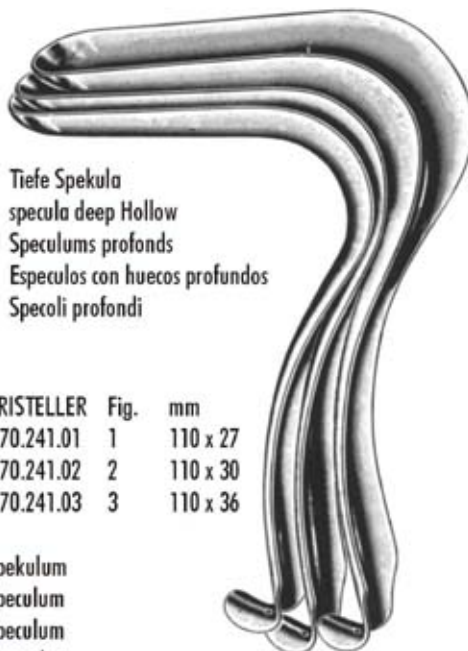

KRISTELLER	Fig.	mm
M70.242.01	1	115 x 23
M70.242.02	2	115 x 26
M70.242.03	3	115 x 32

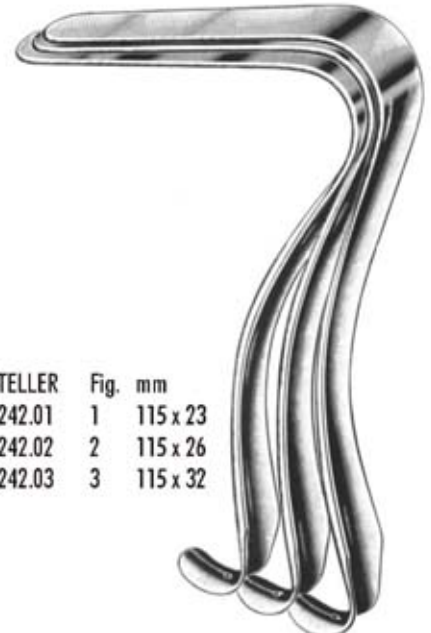

Gynäkologie  
Gynecology  
Gynécologie  
Ginecologia  
Ginecologia

Schneiden-spekula  
Vaginal specula  
Speculum svaginaux  
specoli vaginali



Extra großes Modell  
Extra large pattern  
Modele extra Grand  
Modelo muy grande  
modello molto grande

KRISTELLER  
M70.250.00  
Set

KRISTELLER  
M70.251.00  
135 x 36 mm

KRISTELLER  
M70.252.00  
140 x 30 cm

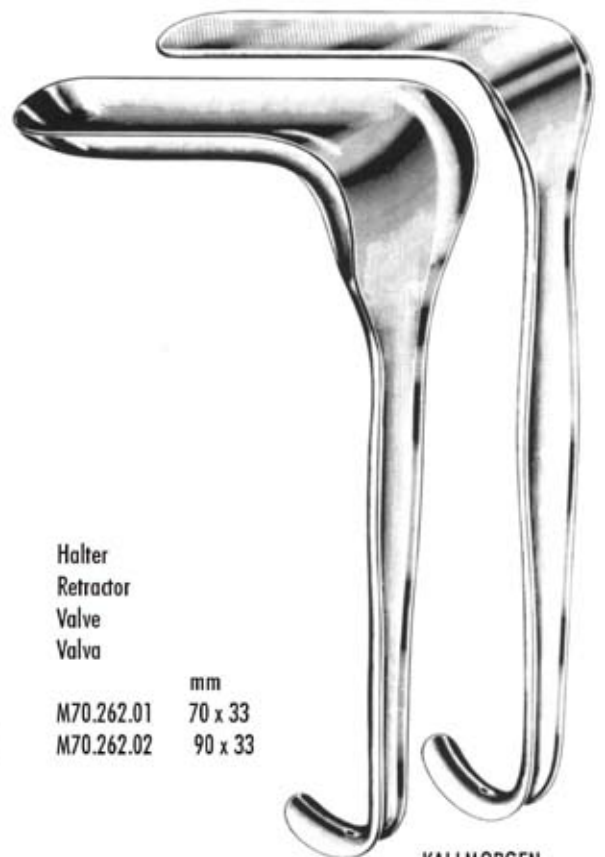

KALLMORGEN  
M70.260.01- M70.262.02

KALLMORGEN	Fig.	Set	Speklum speculum Speculum Esxpeculo Specole	mm	Halter Retractor Valve Valva	mm
	1	M70.260.01	M70.261.01	70 x 40	M70.262.01	70 x 33
	2	M70.260.02	M70.261.02	90 x 40	M70.262.02	90 x 33

Schneiden-Spekula  
Vaginal Specula  
Especulos vaginales  
Specoli vaginali

Gynäkologie  
Gynecology  
Gynécologie  
Ginecologia  
Ginecologia



JACKSON	Fig.	mm
M70.271.01	1	75 x 38
M70.271.02	2	90 x 38
M70.271.03	3	100 x 38



Fig. 1 = klein/small/petit  
pequeno/piccolo  
Fig. 2 = mittel/medium/moyen  
mediano/medio  
Fig. 3 = groß/large/grand  
grande

SIMS	Fig.
M70.281.01	1
M70.281.02	2
M70.281.03	3



SIMS	fig.
M70.291.01	1
M70.291.02	2
M70.291.03	3
M70.291.00	= Set



DOYEN	Fig.	mm
M70.301.01	1	55 x 35
M70.301.02	2	85 x 35
M70.301.03	3	115 x 35
M70.303.01	1	55 x 45
M70.303.02	2	85 x 45
M70.303.03	3	115 x 45
M70.303.04	4	160 x 45
M70.305.01	1	55 x 60
M70.305.02	2	85 x 60
M70.305.03	3	115 x 60
M70.305.04	4	160 x 60

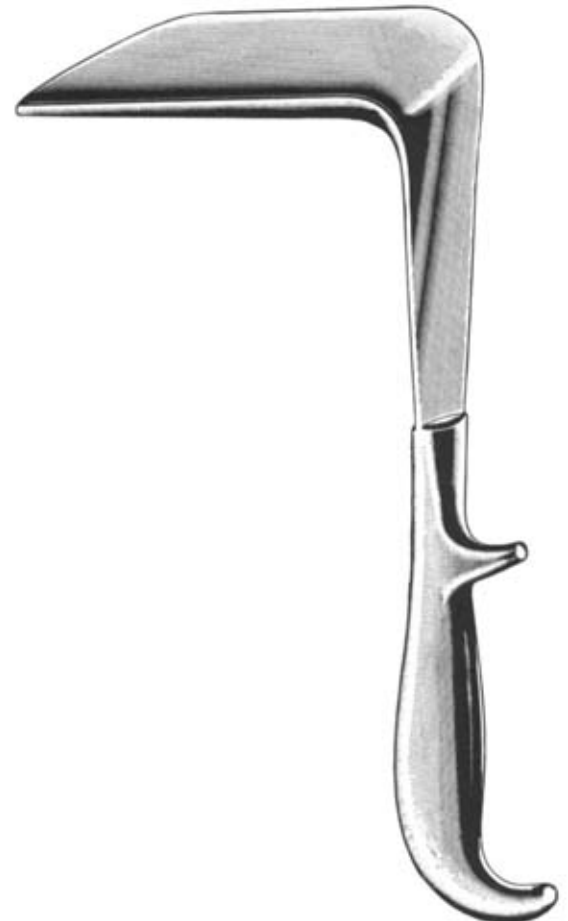

DOYEN  
M70.301.01 - M70.305.04

Gynäkologie  
Gynecology  
Gynécologie  
Ginecología  
Ginecologia



**AUVARD**

M70.307.00 M70.309.00

Festes Gewicht  
fixed Weight  
Poids fixe  
Pesa fija  
Peso fiso



mm	<b>BREISKY</b>
100 x 20	M70.310.20
100 x 25	M70.310.25
100 x 30	M70.310.30
100 x 35	M70.310.35
100 x 40	M70.310.40
130 x 20	M70.310.20
130 x 20	M70.313.25
130 x 25	M70.313.25
130 x 30	M70.313.30
130 x 40	M70.313.40
155 x 40	M70.315.40



mm	<b>LANDAU</b>
100 x 28	M70.319.28
100 x 38	M70.319.38

Schneiden-Spekula  
Vaginal Specula  
Especulos vaginales  
Specoli vaginali



**FRIEDMANN**  
M70.351.10  
10 cm



Standard	<b>KOGAN</b>	<b>LASER</b>
M70.360.24	24 cm	M70.364.24

Uterus-Dilatatoren  
Uterine Dilators  
Dilatateurs utérins  
Dilatadores uterinos  
Dilatatori uterini



mm	HEGAR		mm
1	M70.410.01	M70.415.01	1,5
2	M70.410.02	M70.415.02	2,5
3	M70.410.03	M70.415.03	3,5
4	M70.410.04	M70.415.04	4,5
5	M70.410.05	M70.415.05	5,5
6	M70.410.06	M70.415.06	6,5
7	M70.410.07	M70.415.07	7,5
8	M70.410.08	M70.415.08	8,5
9	M70.410.09	M70.415.09	8,5
10	M70.410.10	M70.415.10	10,5
11	M70.410.11	M70.415.11	10,5
12	M70.410.12	M70.415.12	11,5
13	M70.410.13	M70.415.13	12,5
14	M70.410.14	M70.415.14	13,5
15	M70.410.15	M70.415.15	14,5
16	M70.410.16	M70.415.16	15,5
17	M70.410.17	M70.415.17	16,5
18	M70.410.18		
19	M70.410.19		
20	M70.410.20		
21	M70.410.21		
22	M70.410.22		
23	M70.410.23		
24	M70.410.24		
25	M70.410.25		
26	M70.410.26		
27	M70.410.27	M70.410.14 Satz/Set/Jeu/Juego	
28	M70.410.28	M70.410.17 = 14	
29	M70.410.29	M70.404.26 Satz/Set/Jeu/Juego	
30	M70.410.30	M70.410.26 = 26	

HEGAR  
M70.405.14  
4-17 mm  
14 Stück/ea./pcs./c./u./pezzi



mm HEGAR  
4-17 M70.406.14 14 Stück/ea./pcs./c./u./pezzi  
1-26 M70.406.26 26 Stück/ea./pcs./c./u./pezzi



Uterus-Dilatatoren  
 Uterine Dilators  
 Dilatateurs utérins  
 Dilatadores uterinos  
 Dilatatori uterini



mm	HEGAR
1/2	M70.420.01
3/4	M70.420.03
5/6	M70.420.05
7/8	M70.420.07
9/10	M70.420.09
11/12	M70.420.11
13/14	M70.420.13
15/16	M70.420.15
17/18	M70.420.17
19/20	M70.420.19
21/22	M70.420.21
23/24	M70.420.23
25/26	M70.420.25

M70.424.08 Satz/Set/Jeu/Juego  
 M70.420.03-M70.420.17 = 8

M70.424.13 Satz/Set/Jeu/Juego  
 M70.420.01-M70.420.25 = 13

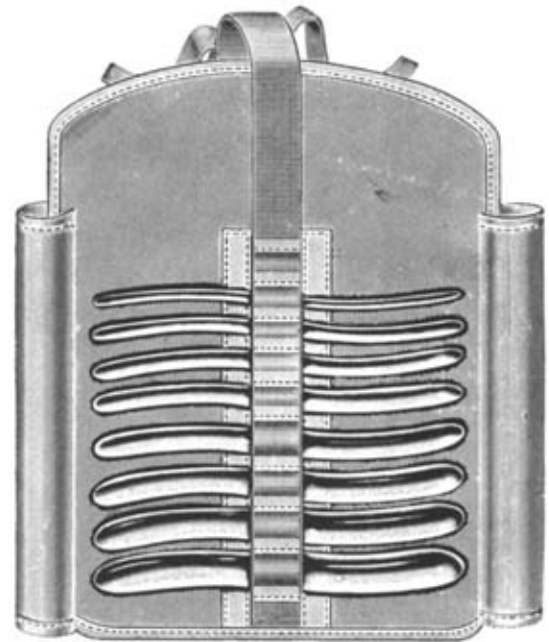

HEGAR  
 M70.425.08  
 3/4-17/18 mm  
 8 Stück/ea./pees./c./u./pezzi



Mm	HEGAR	
3/4-17/18	M70.426.08	8 Stück/ea./pees./c./u./pezzi
1/2-25/26	M70.426.13	8 Stück/ea./pees./c./u./pezzi

Uterus-Dilatatoren  
Uterine Dilators  
Dilatateurs utérins  
Dilatadores uterinos  
Dilatatori uterini

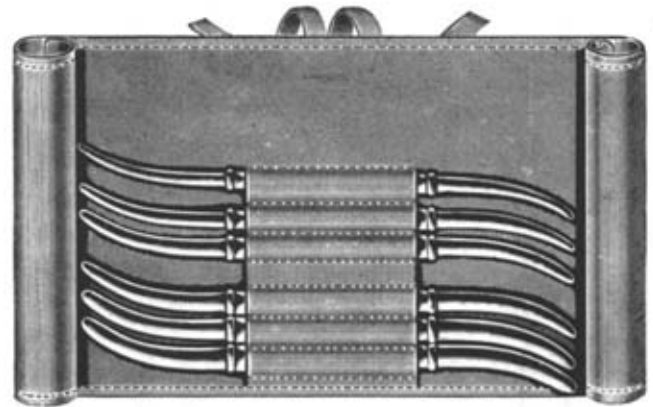

HANK  
M70.436.08  
Set/6

mm	HANK	Fig. US
4,5/	M70.430.10	9/10
5,5/ 6	M70.430.12	11/12
6,5/ 7	M70.420.14	13/14
7,5/ 8	M70.430.16	15/16
8,5/10	M70.430.20	19/20

M70.70.435.06  
Set/6



GOODEL  
M70.441.34  
34 cm



WYLIE  
M70.443.29  
29 cm



SIMS  
M70.445.29  
29 cm

Gynäkologie  
Gynecology  
Gynécologie  
Ginecologia  
Ginecologia

Hakenzangen  
Tenaculum Forceps  
Pinces pour abaissement du col de l'utérus  
Pinzas para coger el cuello de útero  
Pinze per abbassare il collo dell' utero



SCHROEDER  
M70.502.25  
25 cm



BRAUN  
M70.504.25  
25 cm



SKENE  
M70.505.24  
24 cm



DUPLAY  
M70.507.28  
28 cm



STAUDE-MOORE  
M70.508.17  
17 cm



BARRETT  
M70.510.18  
18 cm



JARCHO  
M70.512.20  
20 cm

Gynäkologie  
Gynecology  
Gynécologie  
Ginecología  
Ginecologia

Hakenzangen  
vulsellum forceps  
Pinces Pour abaissement du col de luterus  
Pinzas para coger el cuello del útero  
Pinze per abbassare il collo dell'utero

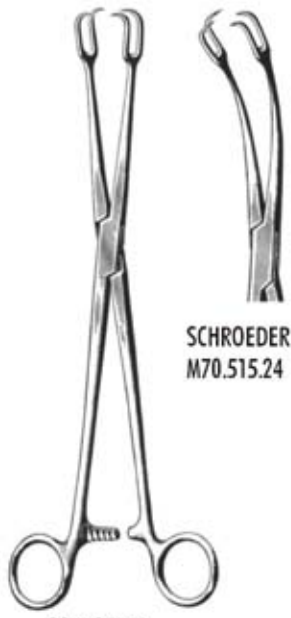

SCHROEDER  
M70.515.24

SCHROEDER  
M70.514.24  
24 cm

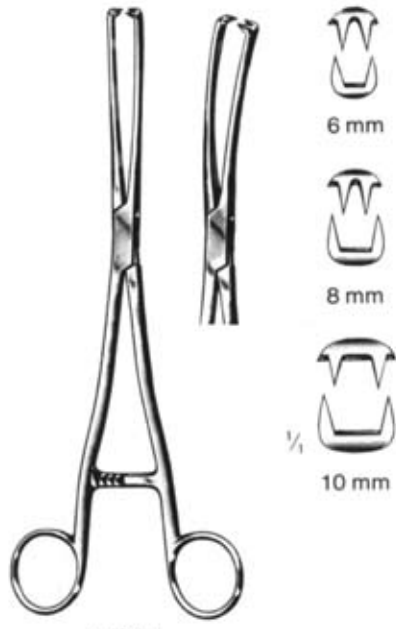

NUSEUX

M70.524.06	6 mm	M70.525.06
M70.524.08	8 mm	M70.525.08
M70.524.10	10 mm	M70.525.10
	24 cm	



TEALE  
M70.531.23  
23 cm



JACOBS  
M70.532.21 21 cm M70.533.21

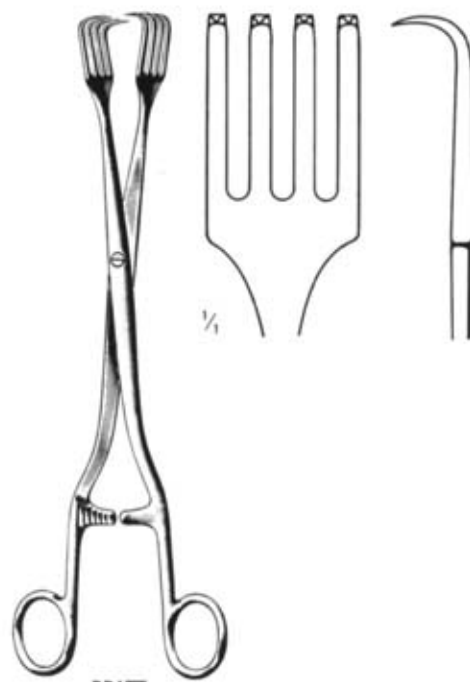

PRATT  
M70.536.28  
28 cm



IOWA  
M70.539.26  
26 cm

Gynäkologie  
Gynecology  
Gynécologie  
Ginecología  
Ginecologia

Uterus-Polypenzangen  
Uterine Polypus Forceps  
Pincès a polypes uterins  
Pinzas para polipos uterinos  
Pinze per polipi uterini



NOTO  
M70.540.27  
27 cm



DOYEN  
M70.542.20  
20 cm

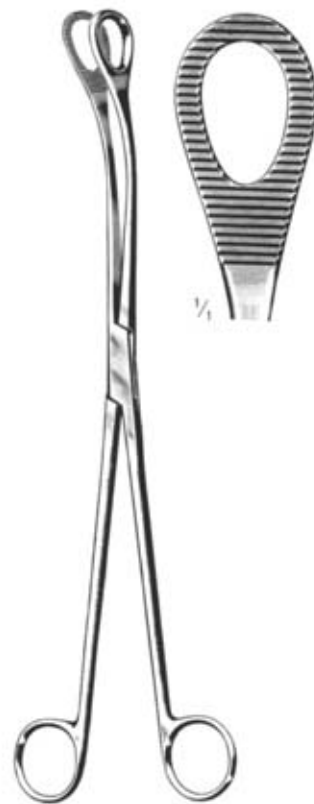

KELLY  
M70.543.32  
32 cm

Uterus-Polypenzangen  
Uterine Polypus Forceps  
Pincès a polypes uterins  
Pinzas para polipos uterinos  
Pinze per afferrare lútero



DARTIGUES  
M70.545.27  
27 cm



SOMER  
M70.547.23  
23 cm



COLLIN  
M70.549.25  
25 cm

Gynäkologie  
Gynecology  
Gynécologie  
Ginecologia  
Ginecologia



Amiotom  
Amniotome  
Amniotome  
Amniotomo  
Amniotomo

BEACHAM  
M70.559.26  
26 cm



Uterus-Depressoren  
Uterine Depressors  
Depresseurs uterins  
Depresores uterinos  
Depressori uterini

BRAUN  
M70.565.28  
28 cm



SIMS  
M70.567.26  
26 cm



Starr  
rigid  
rigide  
rigida  
rigida

SIMS  
M70.580.32  
32 cm

Uterus - Sonden  
Uterine Sounds  
Hysterometres  
Histerometros  
Isterometri

Biigsam  
malleable  
malleable  
maleable  
malleabile

M70.581.32



Starr  
rigid  
rigide  
rigida  
rigida

MARTIN  
M70.582.32  
32 cm

Biigsam  
malleable  
malleable  
maleable  
malleabile

M70.583.32



COLLIN  
M7.584.28  
28 cm

Gynäkologie  
Gynecology  
Gynécologie  
Ginecología  
Ginecologia

Uterus-Biopsie-Saugküretten  
Uterine biopsy Aspirating curettes  
Curettes aspirantes a biopsie de l'úterus  
Curetas aspiradoras p. La biopsia uterina  
Curette di aspirazione per biopsia



RANDALL  
M70.590.04  
24 cm/4 mm



mm NOVAK  
1 M70.592.01  
2 M70.592.02  
3 M70.594.40



KEVORKIAN  
1,2 mm  
4,0 mm  
30 cm

Mit Korb  
with basket  
avec grille  
con cesto  
con cestino

M70.594.12  
M70.594.40  
M70.596.40

Gynäkologie  
Gynecology  
Gynécologie  
Ginecologia  
Ginecologia

Probeexcisionszangen  
Biopsy specimen Forceps  
Pincès emporte-pièce pour le col de l'utérus  
Pinzas sacabocado para el cuello del útero  
Pinze taglianti per biopsia

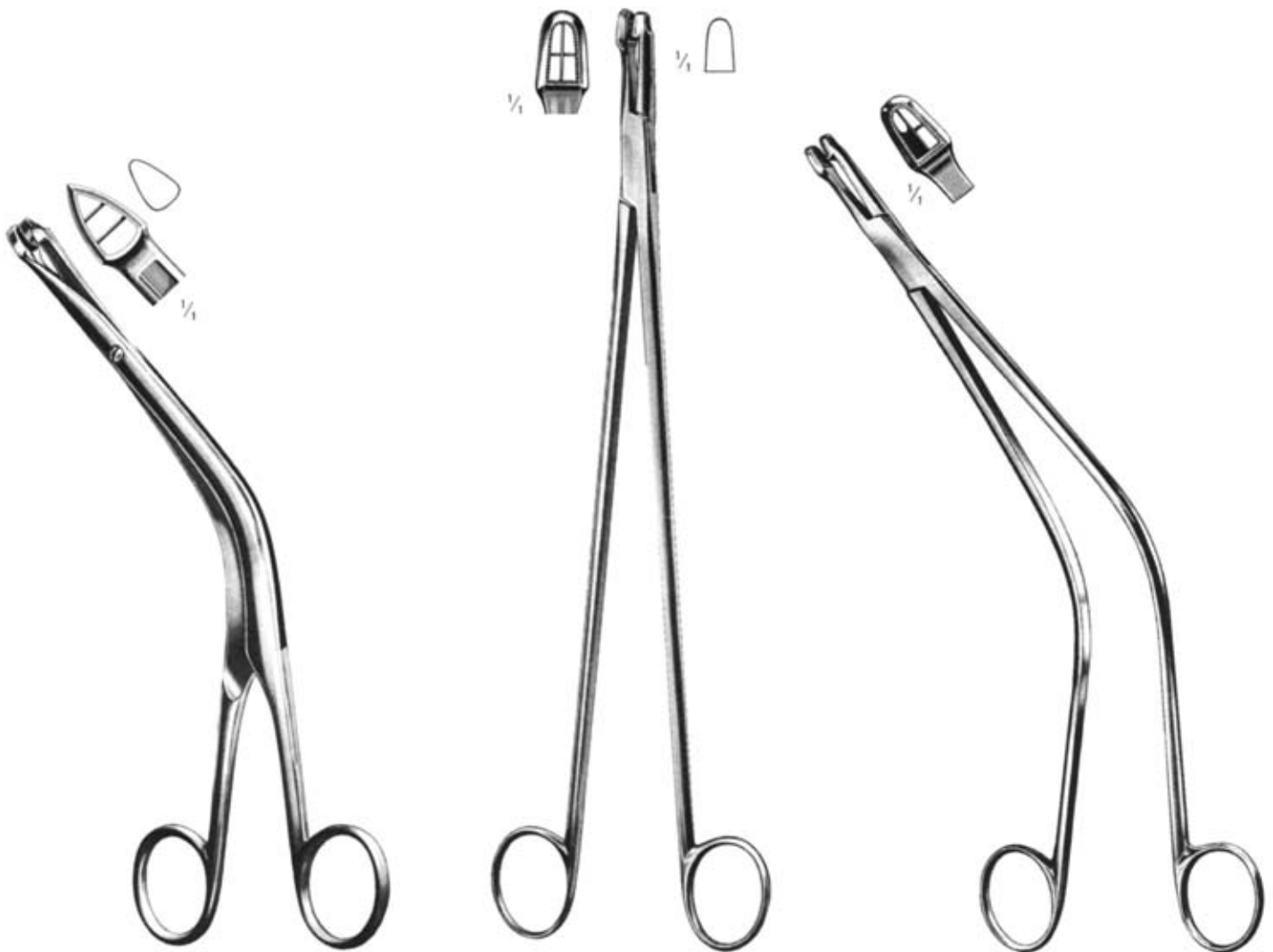

FAURE  
M70.601.21  
21 cm

cm SCHUBERT  
21 M70.604.21  
28 M70.604.28

SCHUBERT  
M70.605.26  
26 cm



Gynäkologie  
Gynecology  
Gynécologie  
Ginecología  
Ginecologia

Biopsiezangen  
Biopsy Specimen Forceps  
Pinces a biopsie  
Pinzas sacabocado p. Biopsia  
Pinze per biopsia



THOMS-GAYLOR  
M70.606.24  
24 cm



GELLHORN  
M70.609.23  
23 cm



van DOREN  
M70.611.25  
25 cm

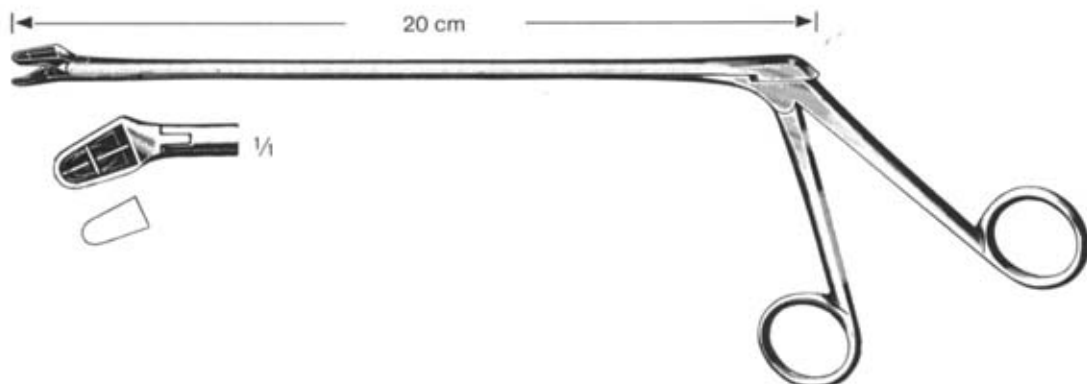

ALEXANDER  
M70.613.28  
28 cm

Biopsiezangen  
Biopsy Specimen Forceps  
Pinces à biopsie  
Pinzas sacabocado p. biopsia  
Pinze per biopsia

 M70.615.01

 M70.615.02

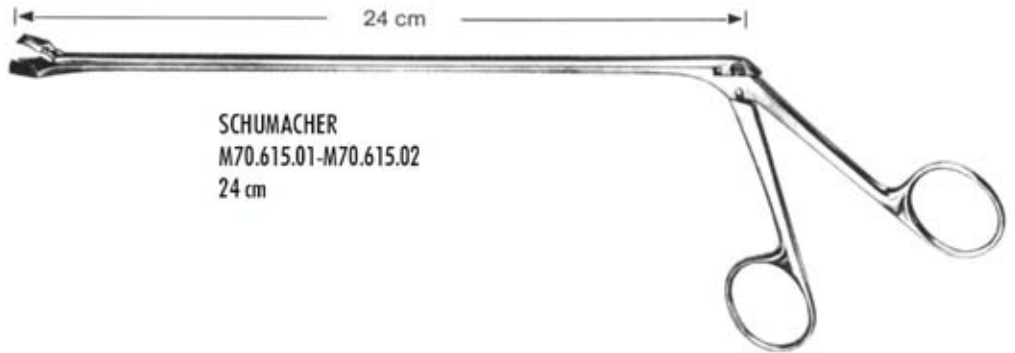

SCHUMACHER  
M70.615.01-M70.615.02  
24 cm



  
3x9,7 mm

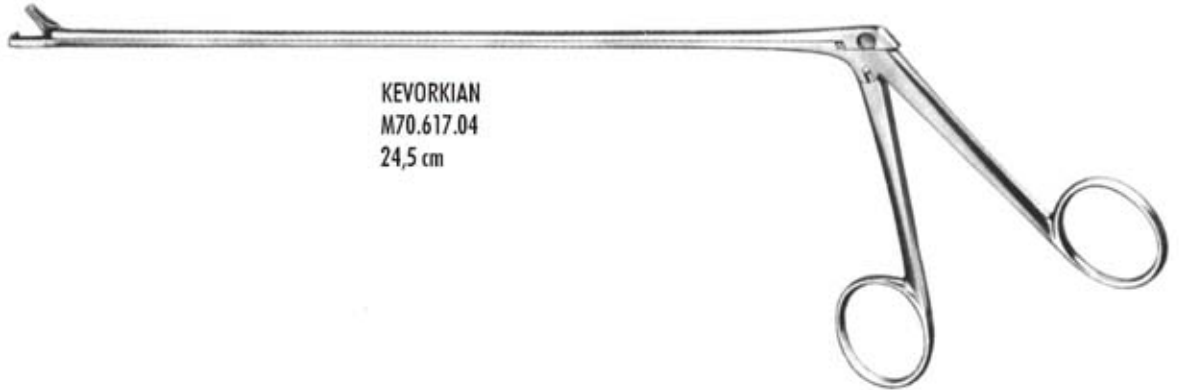

KEVORKIAN  
M70.617.04  
24,5 cm



  
4x8 mm

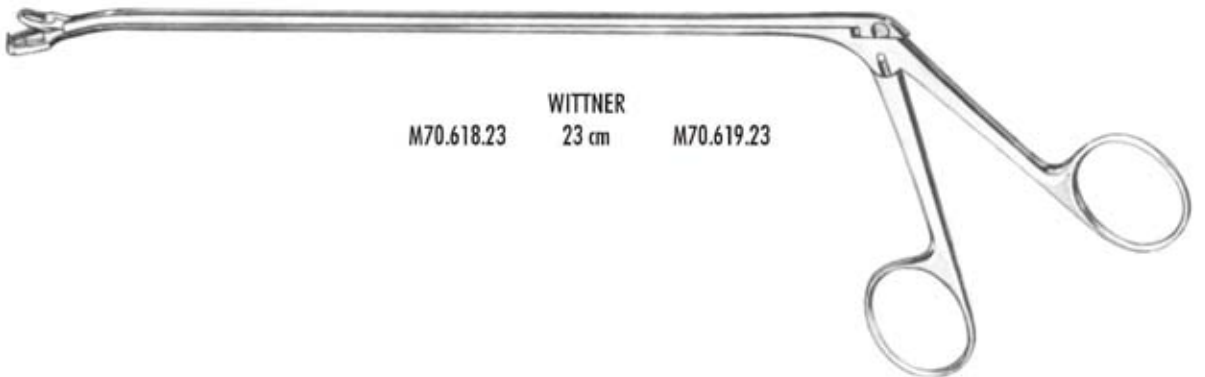

M70.618.23    WITTNER    23 cm    M70.619.23



  
3x7 mm

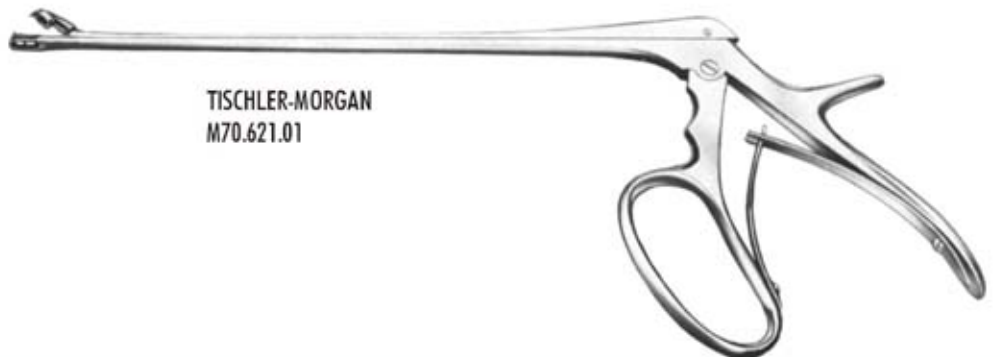

TISCHLER-MORGAN  
M70.621.01

Gynäkologie  
Gynecology  
Gynécologie  
Ginecología  
Ginecologia

Biopsiezangen  
Biopsy Specimen Forceps  
Pincas a biopsie  
Pinzas sacabocado p. Biopsia  
Pinze per biopsia



Oval  
7 x 5 mm

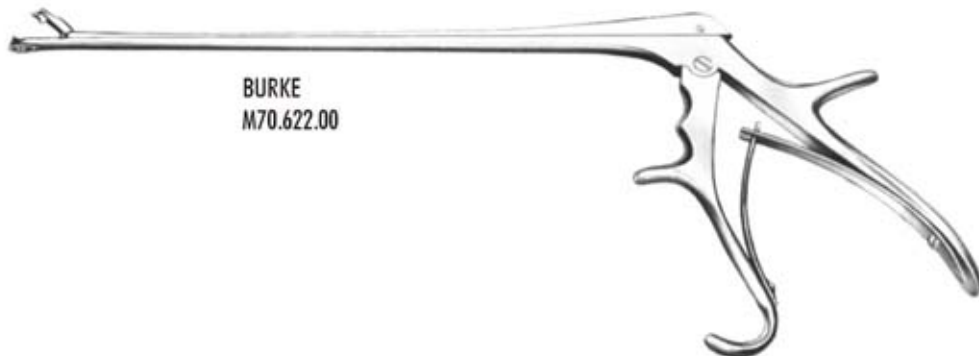

BURKE  
M70.622.00



Fig. 1

TISCHLER-Morgan

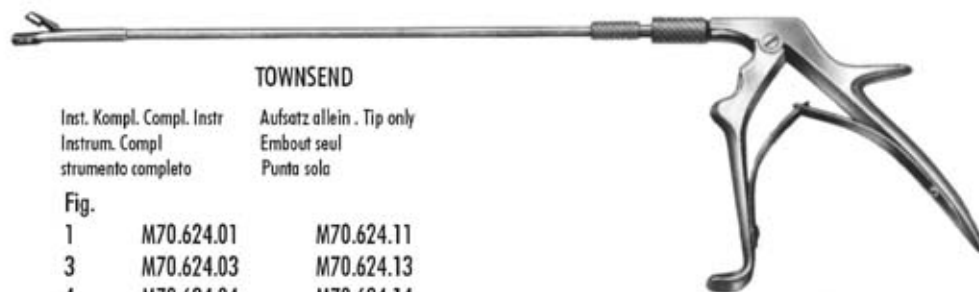

TOWNSEND

Inst. Kompl.	Compl. Instr.	Aufsatz allein . Tip only
Instrum. Compl.	strumento completo	Embout seul
		Punta sola

Fig.

1	M70.624.01	M70.624.11
3	M70.624.03	M70.624.13
4	M70.624.04	M70.624.14
5	M70.624.05	M70.624.15



oval ● 3,7 x 5 mm



mini



- KEVORKIAN



■ 3 x 8 mm

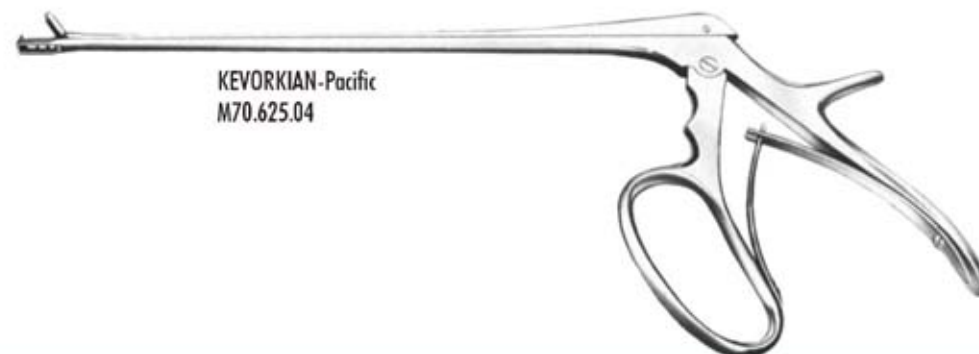

KEVORKIAN-Pacific  
M70.625.04

Biopsiezangen  
Biopsy Specimen Forceps  
Pincès à biopsie  
Pinzas sacabocado p. biopsia  
Pinze per biopsia



2,3x4,2 mm



TOWNSEND-Mini  
M70.626.00



3x9,5 mm

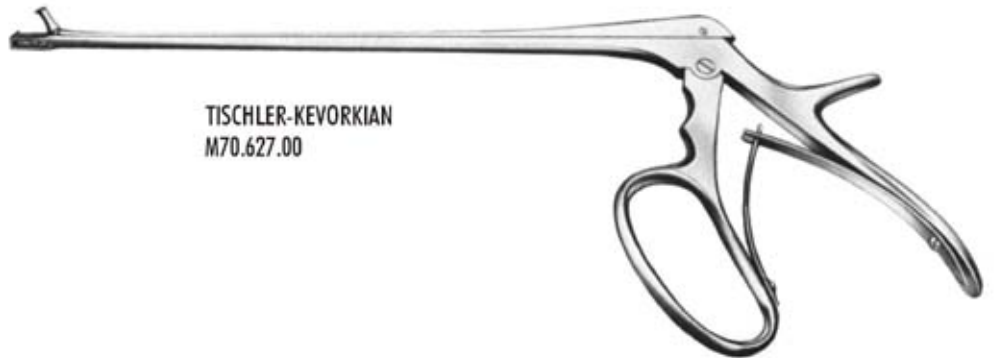

TISCHLER-KEVORKIAN  
M70.627.00



4x6,5 mm

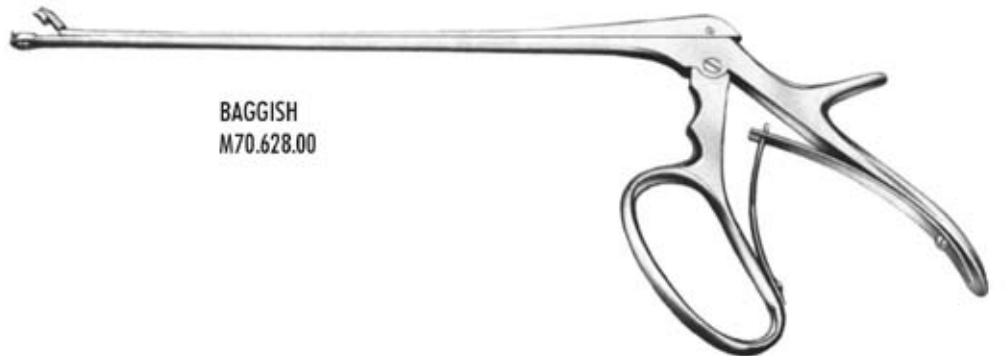

BAGGISH  
M70.628.00



4x8 mm

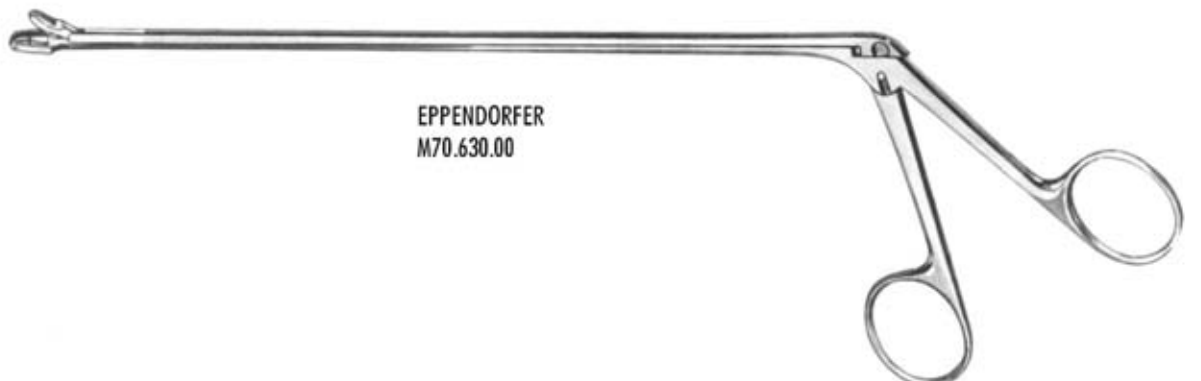

EPPENDORFER  
M70.630.00

Gynäkologie  
Gynecology  
Gynécologie  
Ginecología  
Ginecologia

Biopsiezangen  
biopsy specimen forceps  
Pinces a biopsie  
Pinzas sacabocado p. Biopsia  
Pinze per biopsia

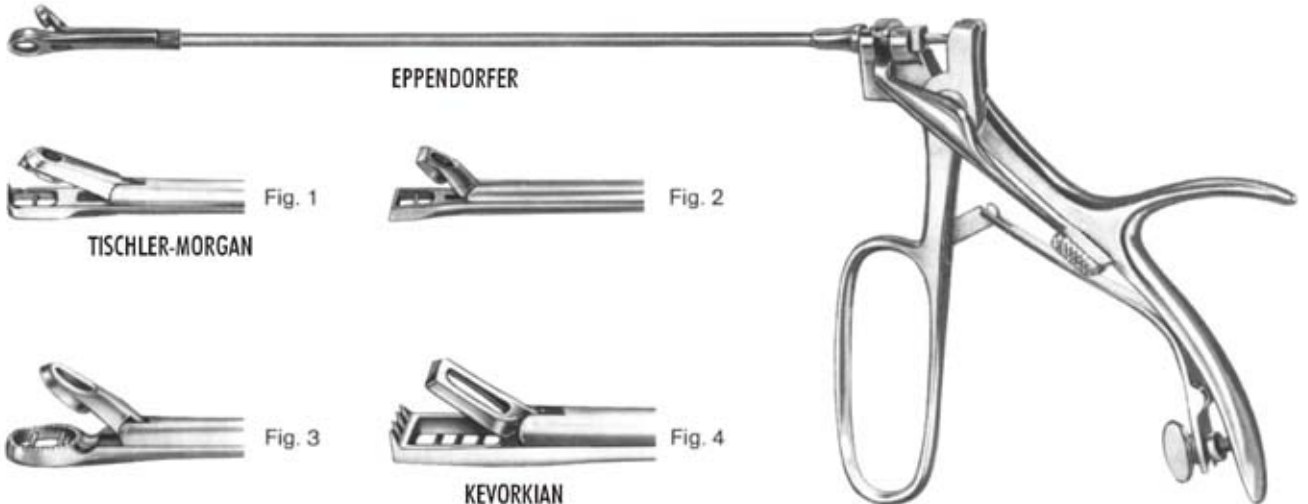

Fig.	Instr. Kompl. . Compl instr. Instrum. Compl. strumento completo	Aufsatz allein . Tip only Embout seul Punta sola
1	M70.632.01	M70.632.11
2	M70.632.02	M70.632.12
3	M70.632.03	M70.632.13
4	M70.632.04	M70.632.14

Myom-Heber  
Myoma Screw  
Tracteur pour fibromes  
Tirabuzon para fibromas  
Tiramiomi



DOYEN  
M70.641.17  
17 cm

Myommesser  
Myoma Knife  
bistouri a fibromes  
Bisturi para fibromas  
busturi per fibromi



SEGOND  
M70.643.27  
27 cm

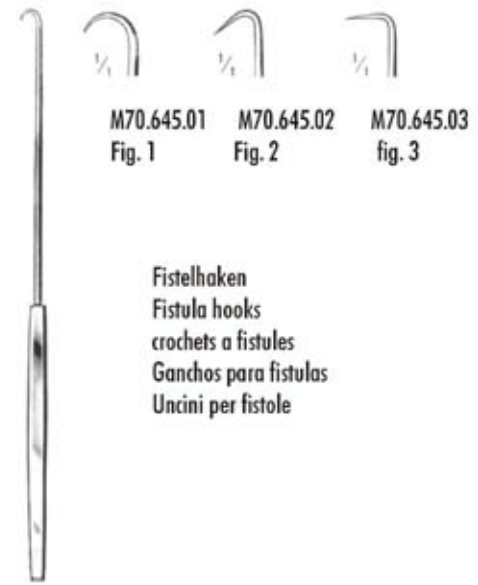

EMMET  
M70.645.01-M70.645.03  
22 cm

Fistelhaken  
Fistula hooks  
crochets a fistules  
Ganchos para fistulas  
Uncini per fistole

Salpingograph  
Salpingograph  
Salpingographie  
Salpingografo  
Salpingografo

Gynäkologie  
Gynecology  
Gynécologie  
Ginecología  
Ginecologia

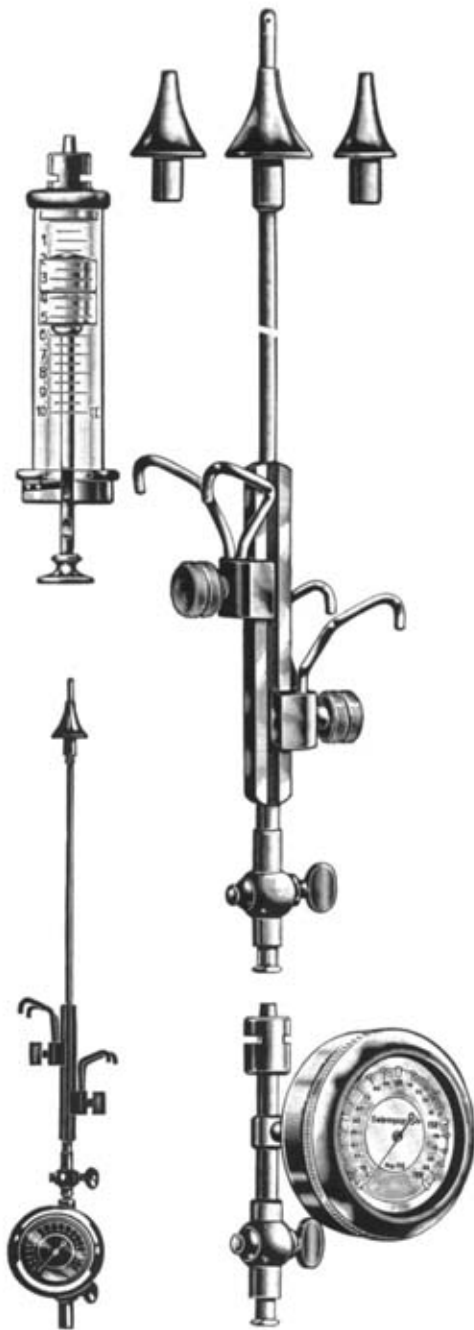

SCHULTZE  
M70.650.00  
compl.

Scharf  
sharp  
tranchant  
cortante  
tagliente



Fig. SIMON  
1 M70.702.01  
2 M70.702.02  
3 M70.702.03  
4 M70.702.04  
5 M70.702.05  
6 M70.702.06  
25 cm



Uteruslöffel, -kürette  
Uterine curettes  
Curettes uterines  
Curetas uterinas  
Curette uterine

Scharf/stumpf  
sharp/blunt  
tranchant/mousse  
cortante/roma  
tagliente/smussa



BLAKE  
M70.704.27  
27 cm

Gynäkologie  
Gynecology  
Gynécologie  
Ginecología  
Ginecologia

Uterus-Küretten  
Uterine currettes  
Currettes uterines  
Curetas uterinas  
Curette uterine

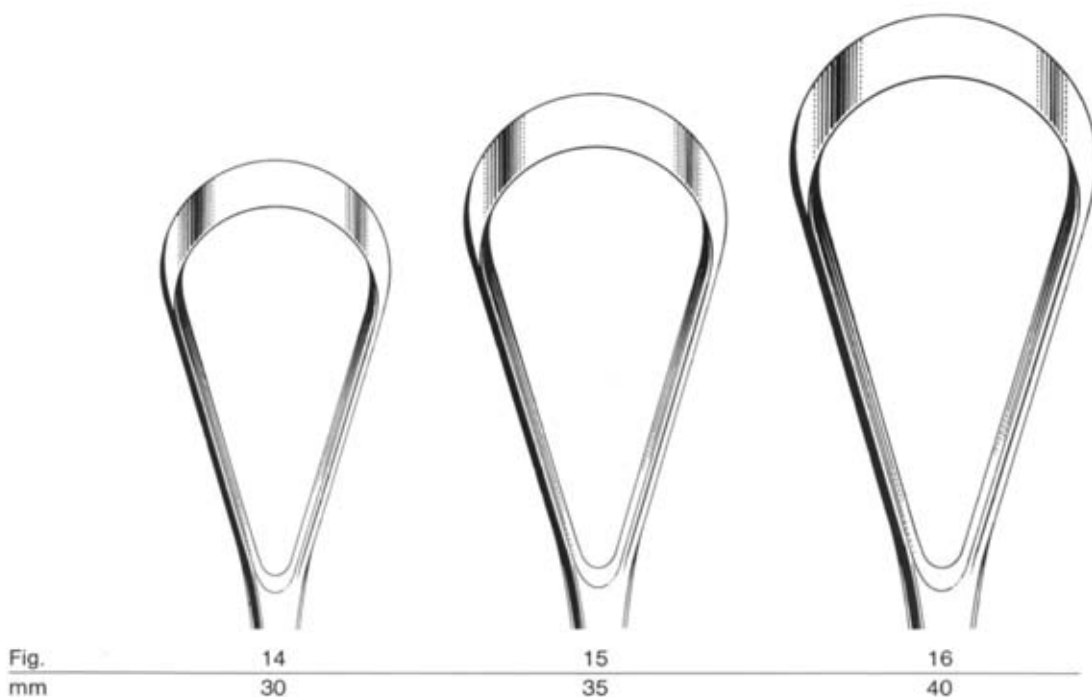
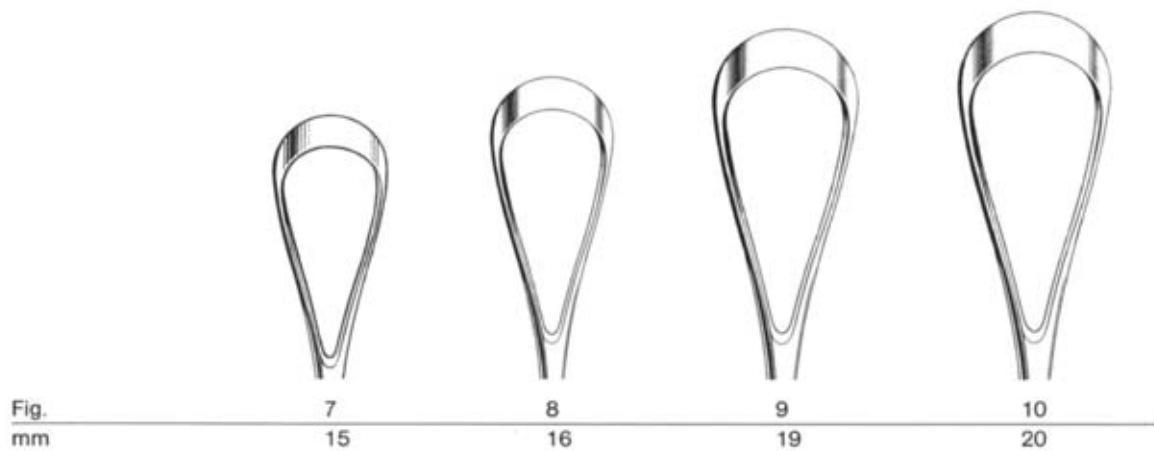
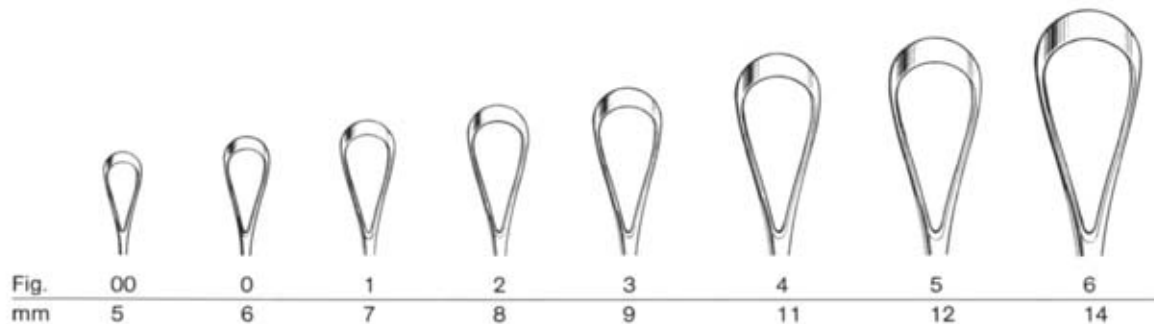

SIMS  
RECAMIER  
BLUMM  
M70.710.05-M70.737.40

Gynäkologie  
Gynecology  
Gynécologie  
Ginecología  
Ginecologia

Uterus-Küretten  
Uterine curettes  
Curettes uterines  
Curetas uterinas  
Curette uterine



**SIMS**  
M70.710.05-M70.717.14



**RECAMIER**  
M70.720.07 - M70.727.20



**BUMM**  
M70.730.30-M70.737.40

Ausführung	scharf	stumpf
Features	sharf	blunt
Execution	tranch.	Mousse
Ejecucion	cort.	Roma
Esecuzione	tagl.	Smussa
Fest/rig.	A	B
flex./fless.	C	D

Fig.	A	B	C	D	A	B	C	D	A	B	C	D
00	M70.710.05	M70.712.05	M70.715.05	M70.717.05								
0	M70.710.06	M70.712.06	M70.715.06	M70.717.06								
1	M70.710.07	M70.712.07	M70.715.07	M70.717.07	M70.720.07	M70.722.07	M7.725.07	M70.727.07				
2	M70.710.08	M70.712.08	M70.715.08	M70.717.08	M70.720.08	M70.722.08	M7.725.08	M70.727.08				
3	M70.710.09	M70.712.09	M70.715.09	M70.717.09	M70.720.09	M70.722.09	M7.725.09	M70.727.09				
4	M70.710.10	M70.712.10	M70.715.10	M70.717.10	M70.720.11	M70.722.11	M7.725.11	M70.727.11				
5	M70.710.11	M70.712.11	M70.715.11	M70.717.11	M70.720.12	M70.722.12	M7.725.12	M70.727.12				
6	M70.710.12	M70.712.12	M70.715.12	M70.717.12	M70.720.14	M70.722.14	M7.725.14	M70.727.14				
7					M70.720.15	M70.722.15	M7.725.15	M70.727.15				
8					M70.720.16	M70.722.16	M7.725.07	M70.727.16				
9					M70.720.19	M70.722.19	M7.725.07	M70.727.19				
10					M70.720.20	M70.722.20	M7.725.07	M70.727.20				
14									M70.730.30	M70.732.30	M70.735.30	M70.737.30
15									M70.730.35	M70.732.35	M70.735.35	M70.737.35
16									M70.730.40	M70.732.40	M70.735.40	M70.737.40



Geburtshilfe  
Obstetrics  
Accouchements  
Obstetricia  
Ostetricia

Geburtszangen  
Obstetrical (Midwifery) Forceps  
Forceps  
Forceps obstetricos  
Forcipi



WRIGLEY  
M72.101.23  
23 cm



SIMPSON  
M72.102.30  
30 cm



cm  
33  
36  
SIMPSON-BRAUN  
M72.105.33  
M72.105.36



De LEE  
M72.107.30  
30 cm



cm  
36  
39  
De LEE  
M72.108.36  
M72.108.39



KIELLAND  
M72.110.41  
41 cm



cm  
32  
38  
ELLIOT  
M72.115.32  
M72.115.38



cm  
36  
40  
NAEGELE  
M72.119.36  
M72.119.40

Geburtszangen  
Obstetrical(Midwifery) Forceps  
Forceps  
Forceps obstetricos  
Forcipi

Geburtshilfe  
Obstetrics  
Accouchements  
Obstetricia  
Ostetricia



LUIKART  
M72.125.40  
40 cm



KIELLAND-LUIKART  
M72.127.40  
40 cm



SIMPSON-LUIKART  
M72.135.36  
36 cm



McLEAN-TUCKER-LUIKART  
M72.139.40  
40 cm



McLEAN-TUCKER  
M72.141.39  
39 cm



McLEAN-LUIKART  
M72.143.39  
39 cm



McLEAN  
M72.145.36  
36 cm



BARTON  
M72.147.36  
36 cm



BARTON  
M72.148.17  
17 cm

Geburtszangen  
Obstetrical (Midwifery) Forceps  
Forceps  
Fórceps obstétricos  
Forcipi



BOERMA  
M72.151.29  
29 cm



PIPER  
M72.155.44  
44 cm



PIPER  
M72.157.40  
40 cm



DEWEY  
M72.160.37  
37 cm

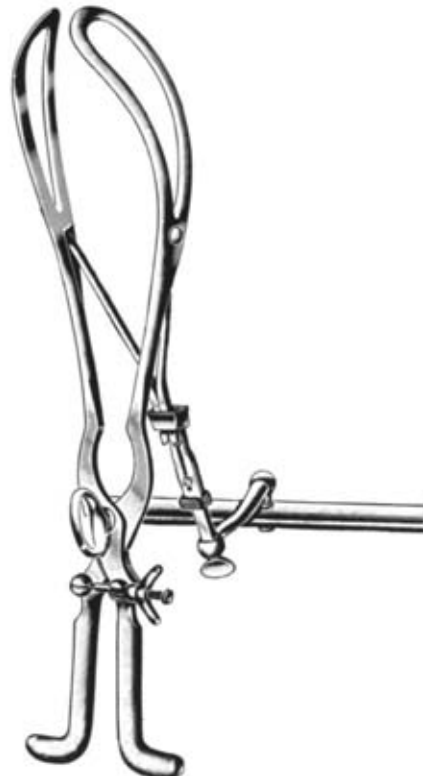

TARNIER  
M72.162.40  
40 cm



BILL  
M72.170.00



LUIKART-BILL  
M72.171.21  
21 cm

Geburtshilfe  
Obstetrics  
Accouchements  
Obstetricia  
Ostetricia



SMELLIE  
M72.181.33  
33 cm



GAUSS  
M72.183.27  
27 cm

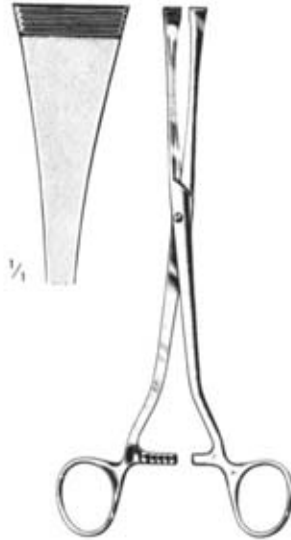

GREEN-ARMYTAGE  
M72.184.21  
21 cm



COLLIN  
M72.187.09  
9 cm

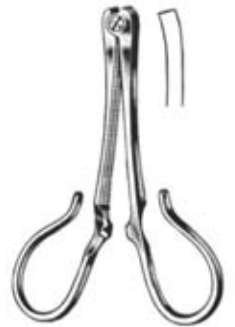

KANE  
M72.189.09  
8,5 cm

Nabelschnurklemmen  
Umbilical Cord clamps  
Clamps p. Cordeon ombilical  
Clamps umbilicales  
Pinze ombelicali

Beckenzirkel  
Pelvimeters  
Compas pelvimetres  
compas pelvimetres  
Pelvimetros  
Pelvimetri



MARTIN  
M72.191.34  
34 cm



COLLIER  
M72.193.30  
30 cm



COLLIN  
M72.195.35  
35 cm

Geburtshilfe  
Obstetrics  
Accouchements  
Obstetricia  
Ostetricia

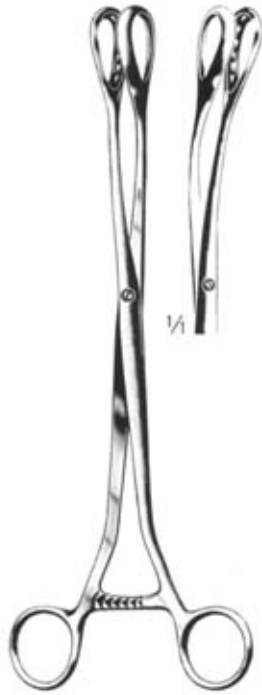

SAENGER  
M72.242.27 27 cm M72.243.27

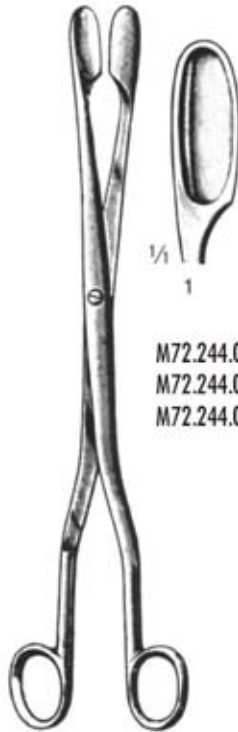

WINTER  
M72.244.01- M72.245.03  
28 cm

M72.244.01  
M72.244.02  
M72.244.03

Fig.  
1  
2  
3

M72.245.01  
M72.245.02  
M72.245.03

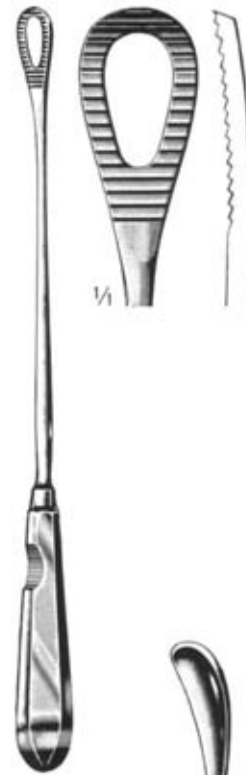

PESTALOZZA  
M72.252.30  
30 cm



M72.254.14  
14,5 mm



M72.254.18  
18 mm



M72.254.21  
21 mm

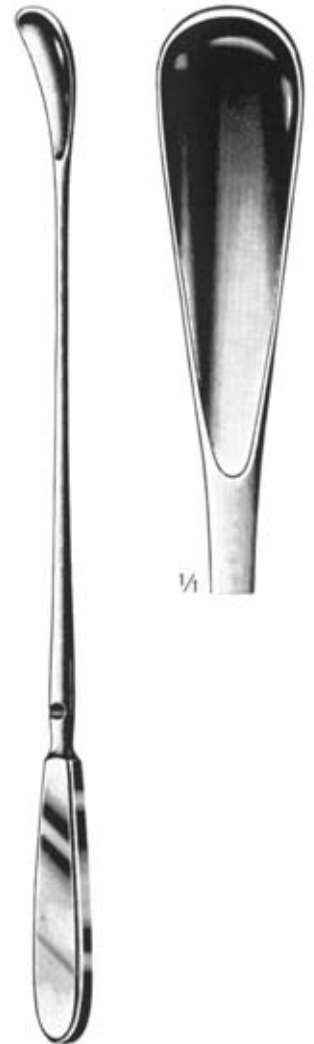

WALLICH  
M72.256.42  
42 cm

Geburtshilfe  
Obstetrics  
Accouchements  
Obstetricia  
Ostetricia



SELLHEIM  
M72.259.28  
28 cm



BRAUN  
M72.302.42  
42 cm

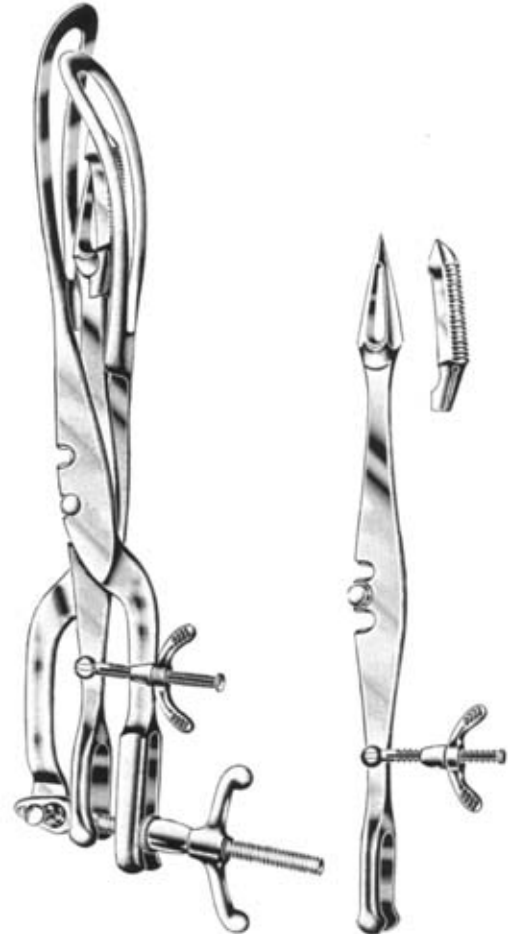

TARNIER  
M72.304.46  
46 cm



SMELLIE  
M72.306.25  
25 cm



BRAUN  
M72.309.30  
30 cm

Dermatologie  
Dermatology  
Dermatologie  
Dermatología  
Dermatologia



**KELNER**  
M74.103.15  
15 cm



**SCHAMBERG**  
M74.111.10  
10 cm



**UNNA**  
M74.113.14  
14 cm



**UNNA**  
M74.115.14  
14 cm



**WALTON**  
M74.118.14  
14 cm



**SAALFELD**  
M74.121.10  
10 cm

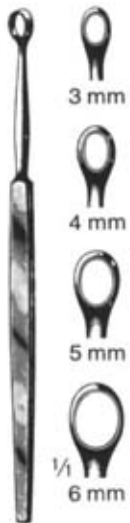

mm	FOX
3	M74.128.03
4	M74.128.04
5	M74.128.05
6	M74.128.06



Fig.	PIFFARD
1	M74.130.01
2	M74.130.02
3	M74.130.03

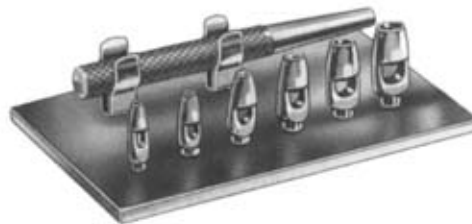

**KEYES**  
M74.138.00  
compl.

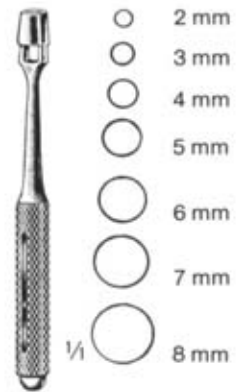

mm	KEYES
2	M74.140.02
3	M74.140.03
4	M74.140.04
5	M74.140.05
6	M74.140.06
7	M74.140.07
8	M74.140.08

Hygiene  
Hygiene  
Hygiène  
Higiene  
Igiene



M70.301.10

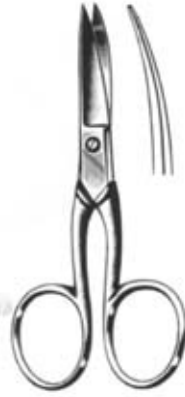

M74.304.10 10 cm M74.305.10



M70.331.14  
14 cm



M70.336.14  
14 cm



cm TRUNBULL  
11,5 M74.341.11  
13,5 M74.341.13



M74.360.13  
13 cm



M74.365.11  
11 cm



M74.373.10  
10,5 cm



M74.378.10  
10 cm



M74.379.10  
10 cm

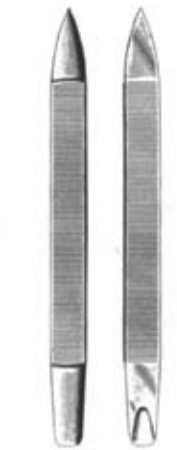

10 cm M74.386.10  
12 M74.386.12



M74.396.00  
10 Ersatzklingen  
10 Spare Blades  
10 lames de rechange  
10 hojas de repuesto  
10 jame di ricambio  
CREDO  
M74.395.14  
14,5 cm



Verschiedene Behälter  
 Different Containers  
 Boîtes diverses  
 Contenedores varios  
 Vassoi diversi



SAUERBRUCH  
 M88.110.21  
 210 x 125 x 17 mm

10/18  
 Edelstahl rostfrei  
 Stainless Steel  
 Acier inoxydable  
 Acero inoxidable  
 Acciaio inossidabile



M88.112.65  
 65 x 15 mm



M88.113.65



M88.114.00  
 150 x 95 x 13 mm



mm x mm x mm			
180	80	40	M88.120.18
200	100	60	M88.120.20
220	120	60	M88.120.22
250	120	60	M88.120.25
300	125	60	M88.120.30
320	150	60	M88.120.32
400	60	75	M88.120.40
500	200	120	M88.120.50

Instrumentenkästen  
 Instrument Cases  
 Boîtes a instruments  
 Cajas para instrumentos  
 Scatole per strumenti



mm x mm x mm			
140	80	50	M88.124.14
170	120	60	M88.124.17
200	60	40	M88.124.20
220	100	50	M88.124.22
270	140	60	M88.124.23
270	170	60	M88.124.27
300	180	65	M88.124.30

Verschiedene Behälter  
 Different Containers  
 Boîtes diverses  
 Contenedores varios  
 Vassoi diversi



mm x mm		
100	100	M88.125.10
120	120	M88.125.12
150	150	M88.125.15
180	180	M88.125.18
200	200	M88.125.20

18/10  
 Edelstahl rostfrei  
 Stainless Steel  
 Acier inoxydable  
 Acero inoxidable  
 Acciaio inossidabile



∅ mm	
40	M88.130.04
40	M88.130.06
40	M88.130.08
40	M88.130.10
40	M88.130.12
40	M88.130.15



mm x mm			
165	60	0,75	M88.133.16
175	70	1,00	M88.133.17
220	80	2,00	M88.133.22
225	90	2,50	M88.133.23
240	110	3,00	M88.133.24
255	115	4,00	M88.133.25
275	115	4,50	M88.133.27
290	125	6,00	M88.133.29
310	120	6,00	M88.133.31
345	125	8,50	M88.133.34
380	130	11,00	M88.133.38
415	140	14,00	M88.133.41



cm	M88.139.17
25*	M88.139.25
27	M88.139.27
* Standard	

Verschiedene Behälter  
 Different Containers  
 Boîtes diverses  
 Contenedores varios  
 Vassoi diversi



0,25	M88.140.02
0,5	M88.140.05
1,0	M88.140.10
2,0	M88.140.20



M88.141.10  
 100 x 20 mm

18/10  
 Edelstahl rostfrei  
 Stainless Steel  
 Acier inoxydable  
 Acero inoxidable  
 Acciaio inossidabile

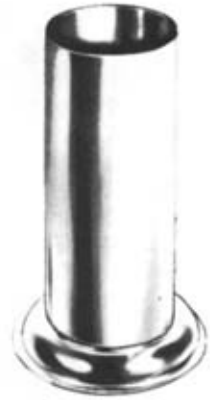

mm x mm		
30 x 90		M88.142.01
50 x 100		M88.142.02
50 x 130		M88.142.03
50 x 175		M88.142.04
75 x 100		M88.142.05
75 x 130		M88.142.06
75 x 175		M88.142.07
100 x 175		M88.142.08
100 x 100		M88.142.09



mm x mm x mm			
200	150	25	M88.144.20
260	180	30	M88.144.26
300	220	30	M88.144.30
350	220	40	M88.144.35
480	330	19	M88.144.48

Instrumentenschalen  
 Instrument Trays  
 Plateaux à instruments  
 Bandejas para instrumentos  
 Bacinelle per strumenti



mm x mm x mm			
220	170	50	M88.146..22
280	200	50	M88.146..28
320	240	50	M88.146..32
370	270	50	M88.146..37
420	320	50	M88.146..42

18/10  
Edelstahl rostfrei  
Stainless Steel  
Acier inoxydable  
Acero inoxidable  
Acciaio inossidabile

Sterilisiertrommeln  
Sterilizing Drums  
Tambours à stérilisation  
Tambores p. esterilización  
Tambori p. sterilizzazione



SCHIMMELBUSCH	mm x mm	KONRICH
M88.152.08	125 x 80	M88.182.08
M88.152.10	125 x 100	M88.182.01
M88.152.12	125 x 125	M88.182.12
M88.155.08	150 x 80	M88.182.08
M88.155.10	150 x 100	M88.182.10
M88.155.13	150 x 130	M88.182.13
M88.155.15	150 x 150	M88.182.15
M88.155.19	150 x 190	M88.182.19
M88.155.14	159 x 145	M88.182.14
M88.159.16	190 x 165	M88.182.16
M88.159.19	190 x 190	M88.182.19
M88.154.24	190 x 240	M88.182.24
M88.164.14	240 x 145	M88.182.14
M88.164.16	240 x 165	M88.182.16
M88.164.19	240 x 190	M88.182.19
M88.164.24	240 x 240	M88.182.24
M88.164.29	240 x 290	M88.182.29
M88.164.34	240 x 340	M88.182.34
M88.164.39	240 x 390	M88.182.39
M88.169.14	290 x 145	M88.182.14
M88.169.16	290 x 165	M88.182.16
M88.169.19	290 x 190	M88.182.19
M88.169.24	290 x 240	M88.182.24
M88.169.29	290 x 290	M88.182.29
M88.159.34	290 x 340	M88.182.34
M88.159.39	290 x 390	M88.182.39
M88.174.14	340 x 145	M88.182.14
M88.174.16	340 x 165	M88.182.16
M88.174.19	340 x 190	M88.182.19
M88.174.24	340 x 240	M88.182.24
M88.154.29	340 x 290	M88.182.29
M88.174.34	340 x 340	M88.182.34
M88.174.39	340 x 390	M88.182.39
M88.179.14	390 x 145	M88.182.14
M88.179.16	390 x 165	M88.182.16
M88.179.19	390 x 190	M88.182.19
M88.179.24	390 x 240	M88.182.24
M88.179.29	390 x 290	M88.182.29
M88.179.34	390 x 340	M88.182.34
M88.179.39	390 x 390	M88.182.39
M88.179.49	390 x 490	M88.182.49
M88.179.59	390 x 590	M88.182.59

Sterilisier-Siebschalen  
Sterilization Trays  
Plateaux à stérilisation  
Bandejas de esterilización  
Cestelli per sterilizzazione

18/10  
Edelstahl rostfrei  
Stainless Steel  
Acier inoxydable  
Acero inoxidable  
Acciaio inossidabile

Aus Drahtgeflecht  
Wire Mesh  
En fil inox  
De alambre  
In rete metallica

Aus perforiertem Blech  
From Perforated Shee Metal  
Entole perforee  
De chapa de acero perforada  
in acciaio perforato

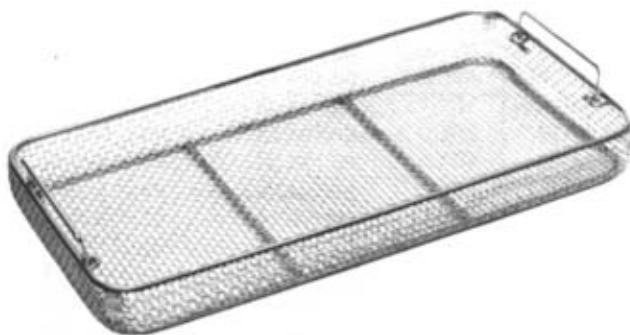

cm x cm x cm  
24 x 25 x 5 M88.240.24  
48 x 25 x 5 M88.240.48  
55 x 25 x 5 M88.240.55



cm x cm x cm  
26 x 26 x 5 M88.250.26  
48 x 26 x 5 M88.250.48

Sterilisier-Container und Zubehör auf Anfrage!  
Sterilization Containers and Accessories, upon request.  
Conteneurs pour la stérilisation et accessoires, sur demande.  
Contenedores para la esterilización, y accesorios, a solicitud.  
Contentitori per la sterilizzazione e Accessori, a richiesta.

Hochfrequenz-Chirurgie  
 High Frequency Surgery  
 Chirurgie à haute fréquence  
 Electrocirugía  
 Electrochirurgia

Elektroden zum Schneiden und Koagulieren  
 Cutting and Coagulation Electrodes  
 Electrodes pour la coupe et la coagulation  
 Electrodo para cortar y para la coagulación  
 Elettrodi di taglio e di coagulazione

Serie MICRO + DENTAL



M90.010.01  
Fig. 1



M90.010.02  
Fig. 2  
45°



M90.010.03  
Fig. 3  
120°



M90.010.11  
Fig. 11  
∅ 3 mm



M90.010.12  
Fig. 12  
∅ 5 mm



M90.010.13  
Fig. 13  
∅ 8 mm



M90.010.14  
Fig. 14



M90.010.15  
Fig. 15  
7,0 x 1,5 mm  
45°



M90.010.16  
Fig. 16  
7 mm  
45°



M90.010.17  
Fig. 17  
6,0 x 1,3 mm



M90.010.18  
Fig. 18  
7,0 x 1,7 mm  
30°



M90.010.21  
Fig. 21  
7,0 x 17 mm



M90.010.31  
Fig. 31  
∅ 0,6 mm  
45°



M90.010.33  
Fig. 33  
∅ 0,17 mm  
45°



M90.010.34  
Fig. 34  
∅ 3,0 mm  
45°



M90.010.35  
Fig. 35



M90.010.36  
Fig. 36  
90°

Schaft . shaft . tige  
 vástago . Asta  
 1,6 mm

Hochfrequenz-Chirurgie  
 High Frequency Surgery  
 Chirurgie à haute fréquence  
 Electrocirugía  
 Electrochirurgia

Elektroden zum Schneiden und Koagulieren  
 Cutting and Coagulation Electrodes  
 Electrodes pour la coupe et la coagulation  
 Electrodo para cortar y para la coagulación  
 Elettrodi di taglio e di coagulazione

Serie MICRO + DENTAL



M90.011.51  
 Fig. 51  
 3 mm  
 45°



M90.011.52  
 Fig. 52  
 7,0 x 1,7 mm  
 45°



M90.011.53  
 Fig. 53  
 45°



M90.011.54  
 Fig. 54  
 45°



M90.011.55  
 Fig. 55



M90.011.56  
 Fig. 56  
 45°



M90.011.61  
 Fig. 61  
 45°



M90.011.62  
 Fig. 62  
 90°

Schaft . Shaft . Tige  
 vástago . Asta  
 4 mm

Serie STANDARD



M90.020.01



M90.020.02



M90.020.03



M90.020.04



∅ mm  
 5 M90.022.05  
 5 M90.022.10  
 20 M90.022.20



∅ mm  
 10 M90.024.10  
 15 M90.024.15  
 20 M90.024.20



∅ mm  
 2 M90.030.0  
 4 M90.030.04  
 6 M90.030.06

Schaft . Shaft . Tige  
 vástago . Asta  
 ∅ 4 mm

Bipolare Koagulation  
Bipolar Coagulation  
Coagulation bipolaire  
Coagulación bipolar  
Coagulazione bipolare

Handchirurgie, Ophthalmologie, Plastische Chirurgie, Experimentelle Chirurgie  
Hand Surgery, Ophthalmology, Plastic Surgery, Experimental Surgery  
Chirurgie de la main, Ophthalmologie, Chirurgie plastique, Chirurgie expérimentale  
Cirugía de la mano, Oftalmología, Cirugía plástica, Cirugía experimental  
Chirurgia della mano, Oftalmologia, Chirurgia plastica, Chirurgia sperimentale



M90.102.11  
11 cm



M90.104.11  
11 cm



M90.105.11  
11 cm  
45°



M90.109.11  
11 cm  
45°



M90.115.11  
11 cm  
45°



Mikrochirurgie, HNO . Microsurgery, ENT . Microchirurgie, ORL . Microcirurgia, ORL . Microchirurgia, ORL



M90.122.16  
16,5 cm



M90.123.16  
16,5 cm



M90.124.16  
16,5 cm  
1 mm



M90.125.16  
16,5 cm



M90.127.16  
16,5 cm  
1 mm



Bipolare Koagulation  
Bipolar Coagulation  
Coagulation bipolaire  
Coagulación bipolar  
Coagulazione bipolare

Mikrochirurgie, HNO . Microsurgery, ENT . Microchirurgie, ORL . Microcirugia, ORL . Microchirurgia, ORL



M90.135.16  
16,5 cm



M90.139.16  
16,5 cm



M90.142.16  
16,5 cm



M90.144.16  
16,5 cm



M90.146.16  
16,5 cm  
1 mm

Gynäkologie . HNO . Tonsillen Chirurgie . Tonsillen Chirurgie . Gynaecology, ENT, Tonsil Surgery . Gynécologie, ORL, Chirurgie des amydales  
Ginecologia, ORL, Cirugia de amigdalas . Ginecologia, ORL, Chirurgia tonsillare



M90.152.19  
19,5 cm



M90.154.19  
19,5 cm  
1 mm



M90.157.19  
19,5 cm  
1 mm



M90.159.19  
19,5 cm  
1 mm

Bipolare Koagulation  
Bipolar Coagulation  
Coagulation bipolaire  
Coagulación bipolar  
Coagulazione bipolare

Neurochirurgie . Neurosurgery . Neurochirurgie . Neurocirurgia . Neurochirurgia



M90.164.19  
19,5 cm



M90.164.19  
19,5 cm  
1 mm



M90.166.19  
19,5 cm  
2 mm



M90.167.19  
19,5 cm  
1 mm



M90.169.19  
19,5 cm  
1 mm



M90.172.03  
0,3 mm



M90.172.07  
0,7 mm



M90.172.12  
1,2 mm

M90.172.03-M90.172.12  
22,5 cm  
0,3-1,2 mm

Bipolare Koagulation  
Bipolar Coagulation  
Coagulation bipolaire  
Coagulación bipolar  
Coagulazione bipolare

Anschlußkabel  
Connection Cords  
Cordon d'alimentation  
Cables de conexión  
Cavi da connessione



m				
3	M90.190.30	M90.191.30	M90.192.30	M90.193.30
5	M90.190.50		M90.192.50	M90.193.50
	ERBE SELECT	AESULAP	USA Mod.	MARTIN

HF-chirurgie-Geräte  
Electrosurgery Equipment  
Electrobistouris  
Electrobisturries  
Elettrobisturi

# **Modesty**

**International Germany**

---

Kurfurstendamm 91  
10709 Berlin Germany.  
Tel: 0049-30-3248392  
Fax: 0049-30-3238333  
URL: [www.modesty-germany.com](http://www.modesty-germany.com)  
E-mail: [modint@modesty-germany.com](mailto:modint@modesty-germany.com)